

ASSEMBLY INSTRUCTIONS

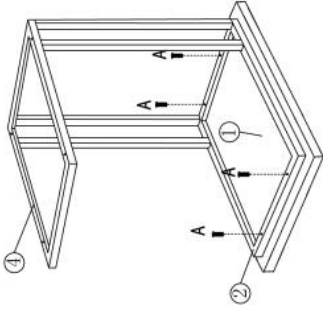

2





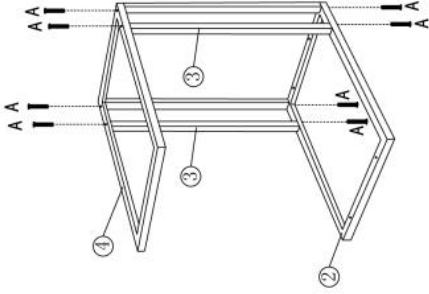

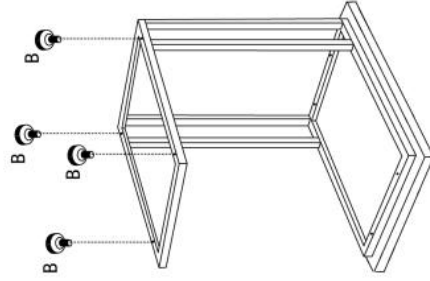

1



3



|   |   |     |
|---|---|-----|
| A |  M6x30mm | X12 |
| B |          | X4  |
| C |          | X1  |
| ① |          | X1  |
| ② |         | X1  |
| ③ |        | X4  |
| ④ |        | X1  |

PART LIST

