

ASSEMBLY INSTRUCTIONS

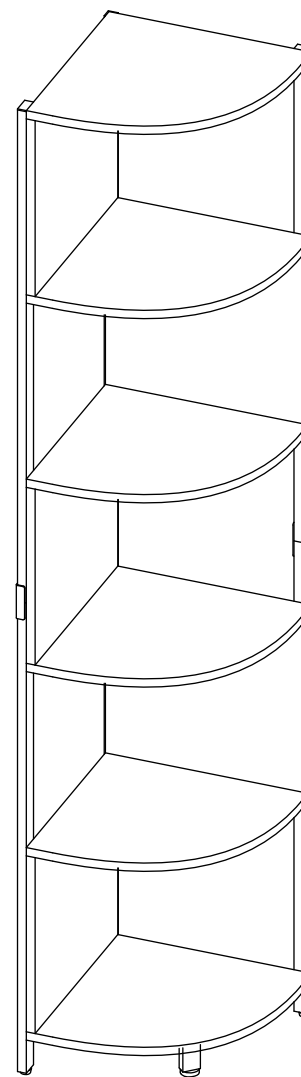



CORNER BOOKSHELF

ASSEMBLY INSTRUCTIONS

Notice:

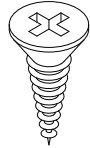
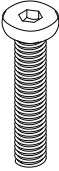
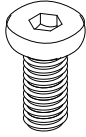
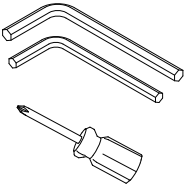
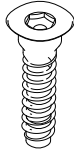
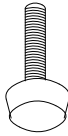
1. Follow the installation instructions. Please confirm all accessories are preset before installation.
2. Do not fully tighten screws during initial assembly. Gently adjust the board and frame to make them level. Only tighten after all pieces are correctly assembled.
3. If you encounter any problems during installation, please contact our customer service.

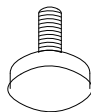
Item no.	Reference Image	Qty.	Item no.	Reference Image	Qty.
A	 M4×12	×4	E	 M6×25	×5
B	 M6×12	×4	F	 ×1 SETS	×1
C	 φ10×40	×20	G	 M6×φ19	×2
D	 φ7.5×50	×22	H	 M6×φ30	×2

ASSEMBLY INSTRUCTIONS

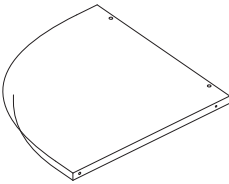
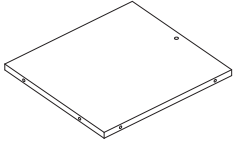
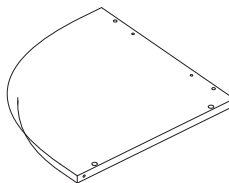
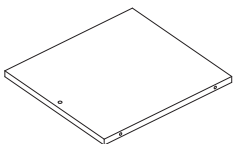
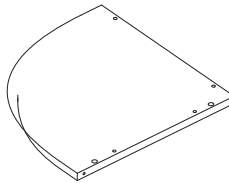
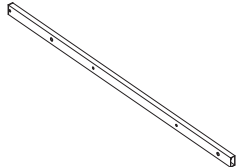
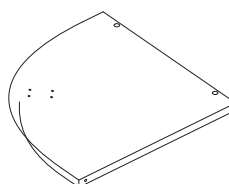
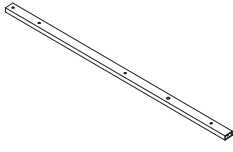
Item no.	Reference Image	Qty.	Item no.	Reference Image	Qty.
1		×1	5		×4
2		×2	6		×1
3		×2	7		×1
4		×1	8		×1

ASSEMBLY INSTRUCTIONS

Item no.	Reference Image	Qty.	Item no.	Reference Image	Qty.
9		×1	13		×1
10		×1	14		×1
11		×2	15		×2 SETS
12		×1	16		×20

ASSEMBLY INSTRUCTIONS

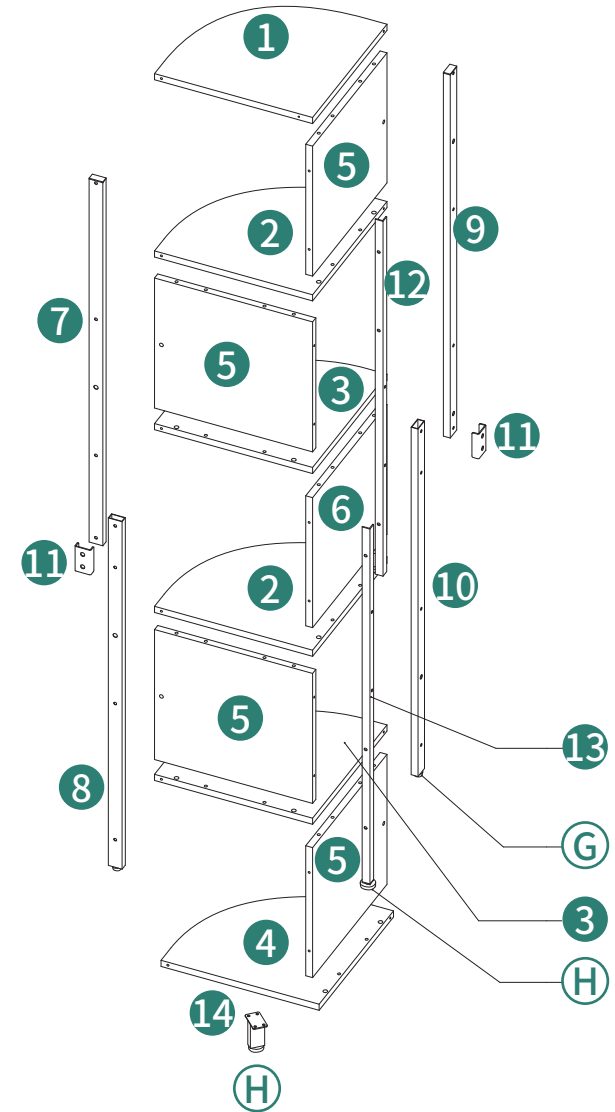

ASSEMBLY INSTRUCTIONS

1

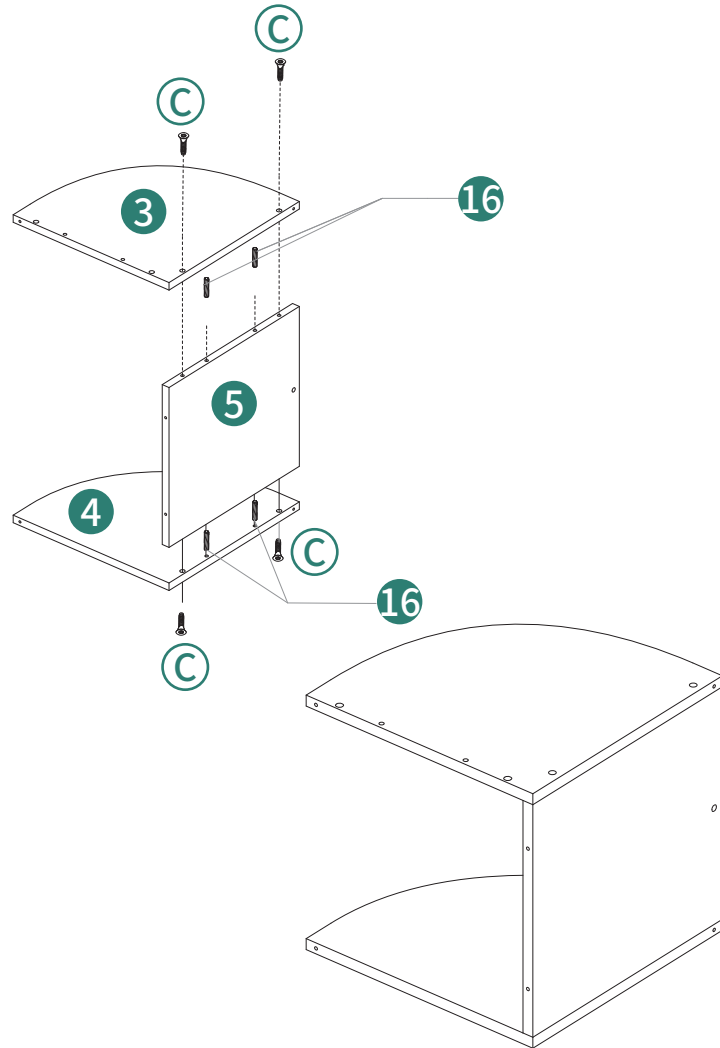
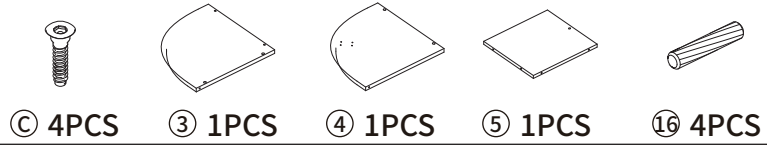

5

ASSEMBLY INSTRUCTIONS

2

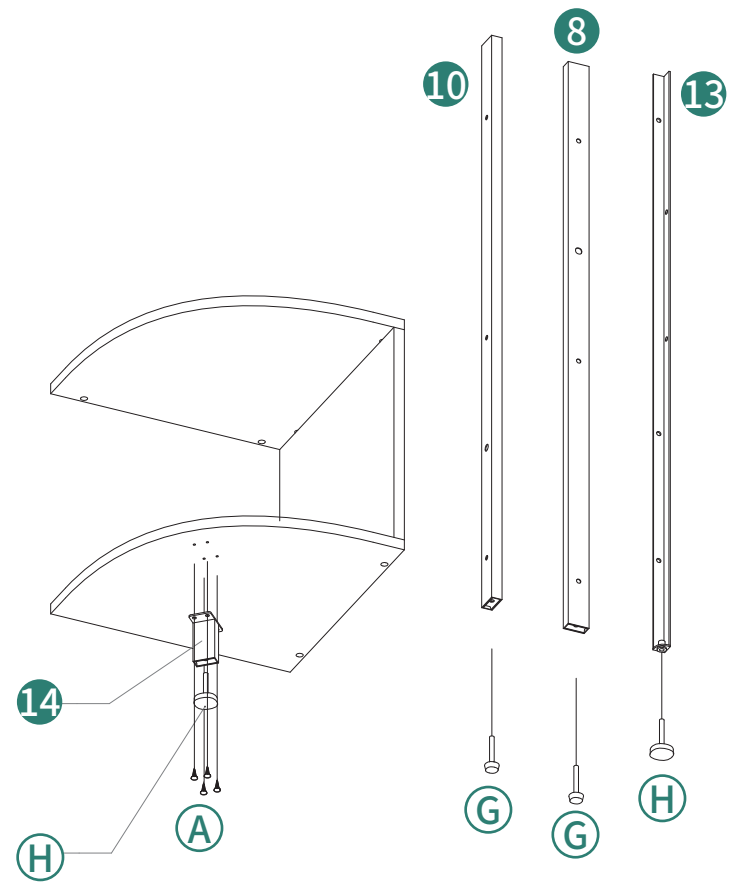
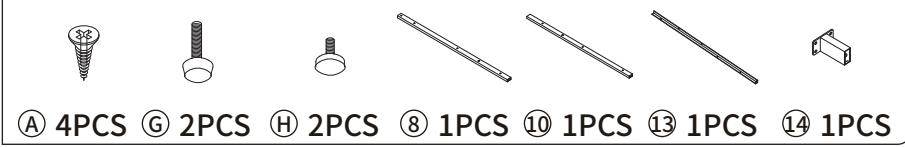

6

ASSEMBLY INSTRUCTIONS

3

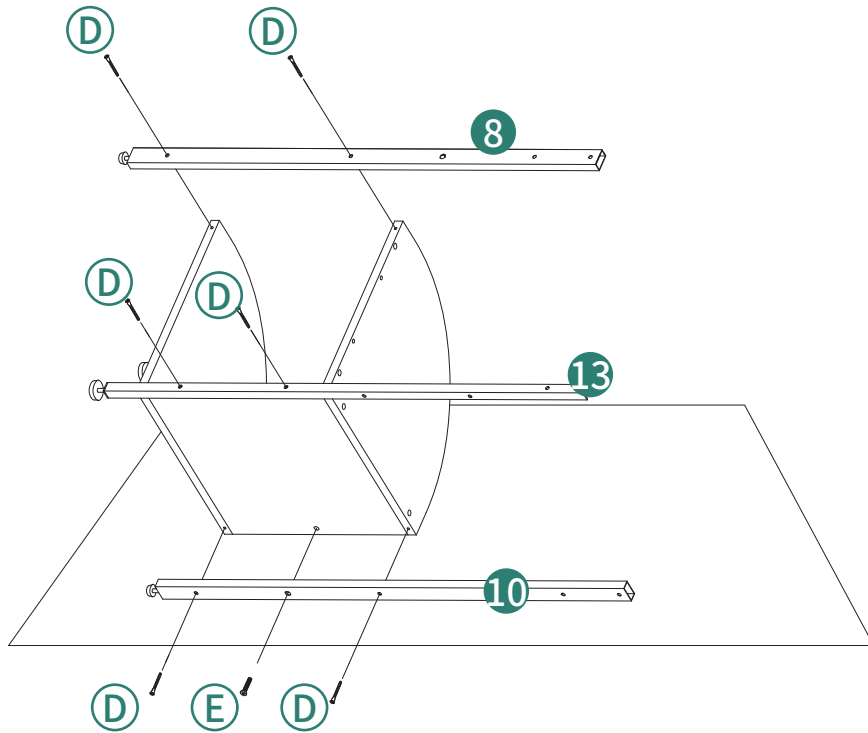
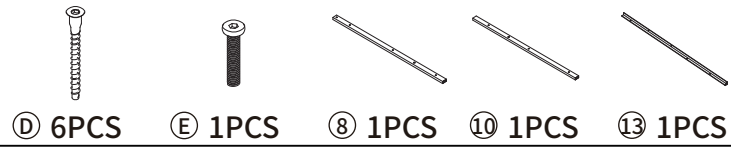

Place on the floor

7

ASSEMBLY INSTRUCTIONS

4

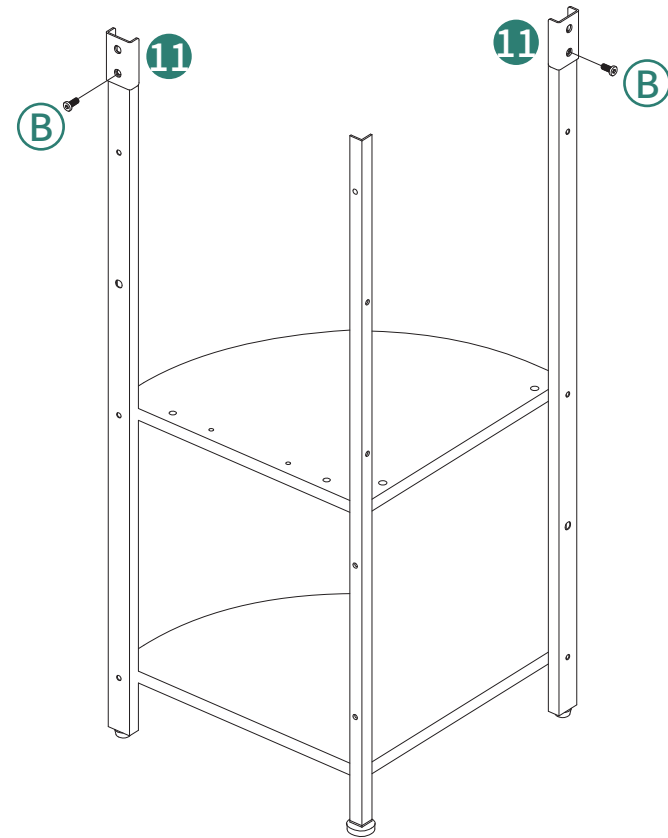
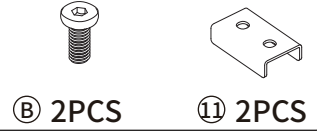

8

ASSEMBLY INSTRUCTIONS

5



Ⓒ 2PCS

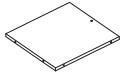

⑤ 1PCS



⑯ 2PCS

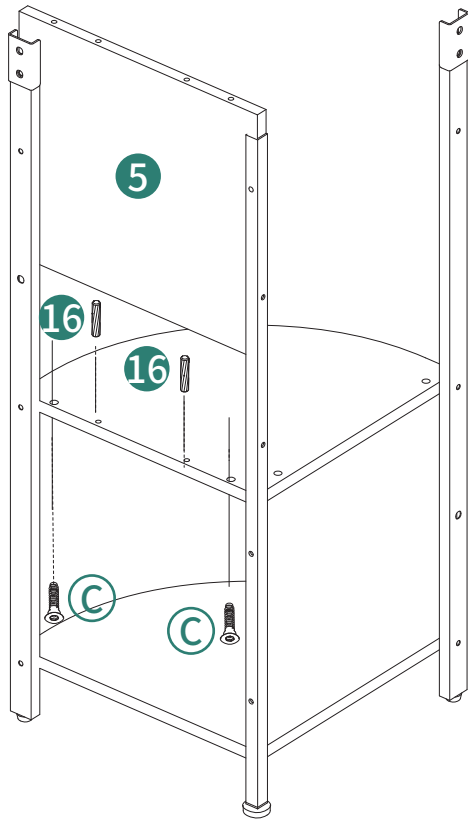

9

ASSEMBLY INSTRUCTIONS

6



Ⓒ 2PCS



Ⓓ 4PCS



Ⓔ 1PCS

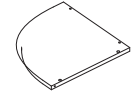

② 1PCS



⑯ 2PCS

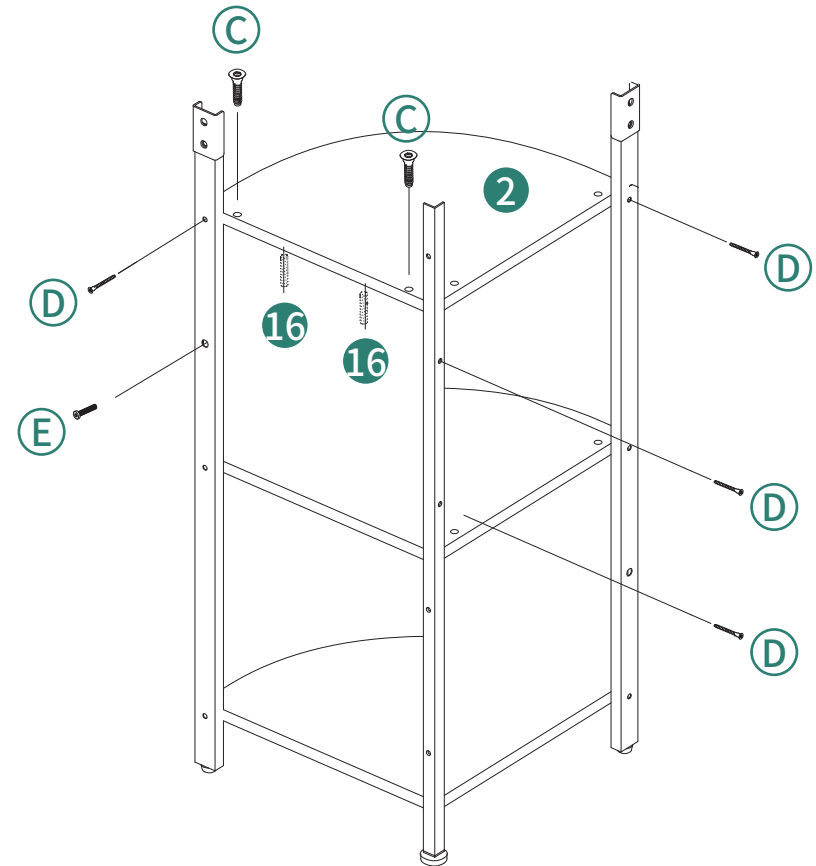

10

ASSEMBLY INSTRUCTIONS

7

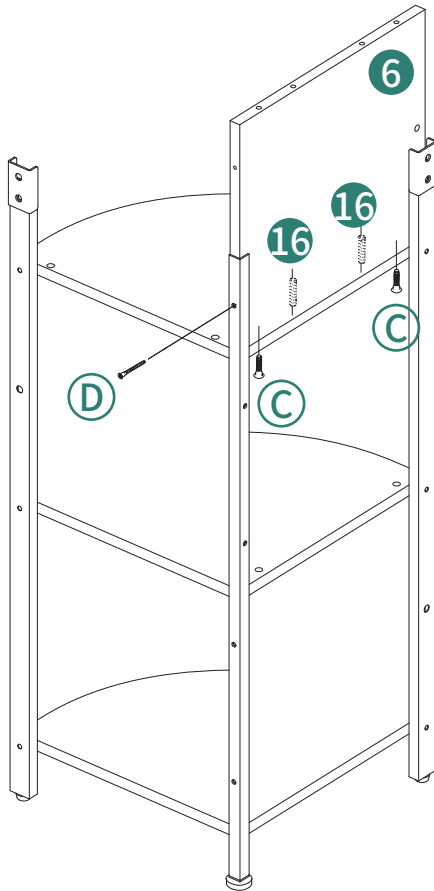
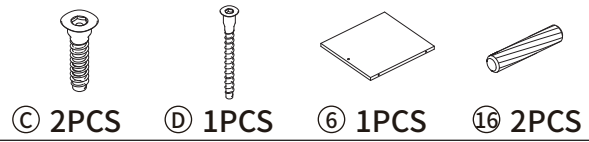

11

ASSEMBLY INSTRUCTIONS

8

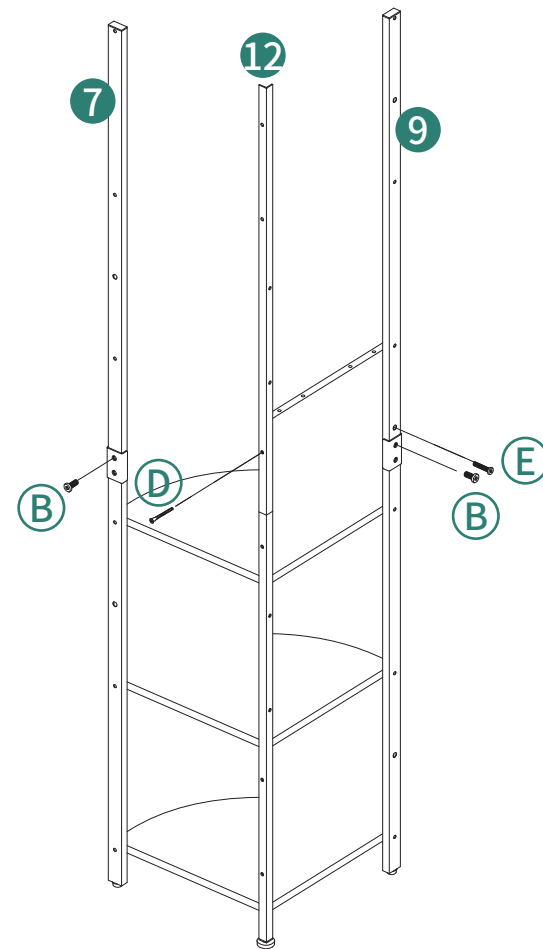
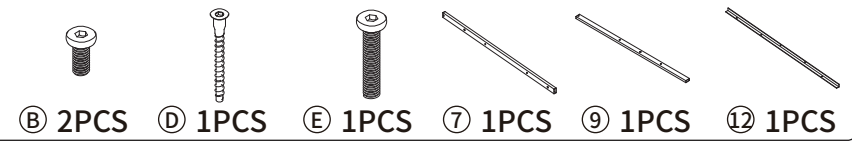

12

ASSEMBLY INSTRUCTIONS

9



C 2PCS



D 2PCS

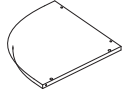

3 1PCS



16 2PCS

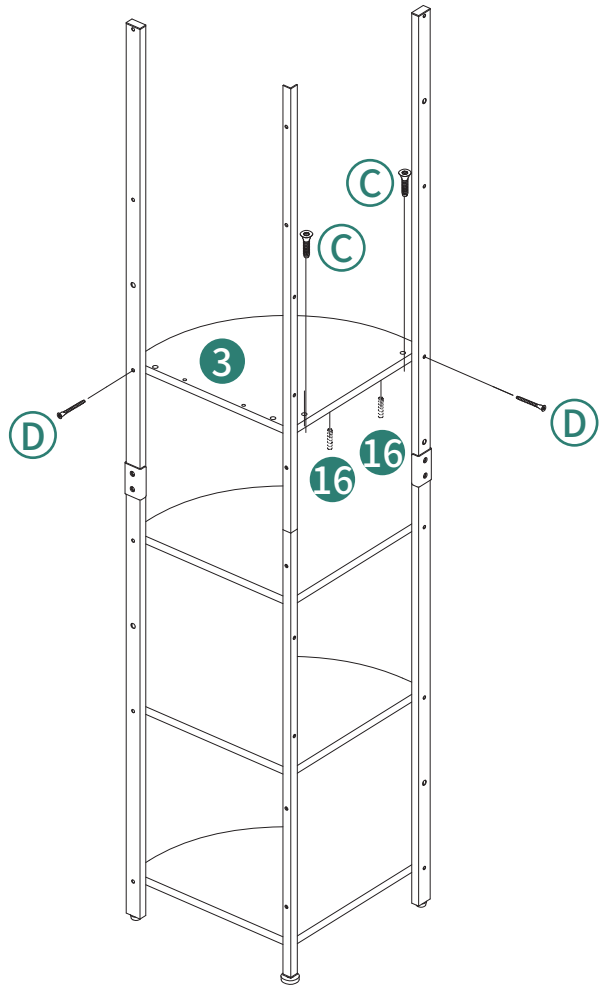

13

ASSEMBLY INSTRUCTIONS

10



C 2PCS



E 1PCS

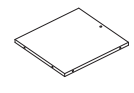

5 1PCS



16 2PCS

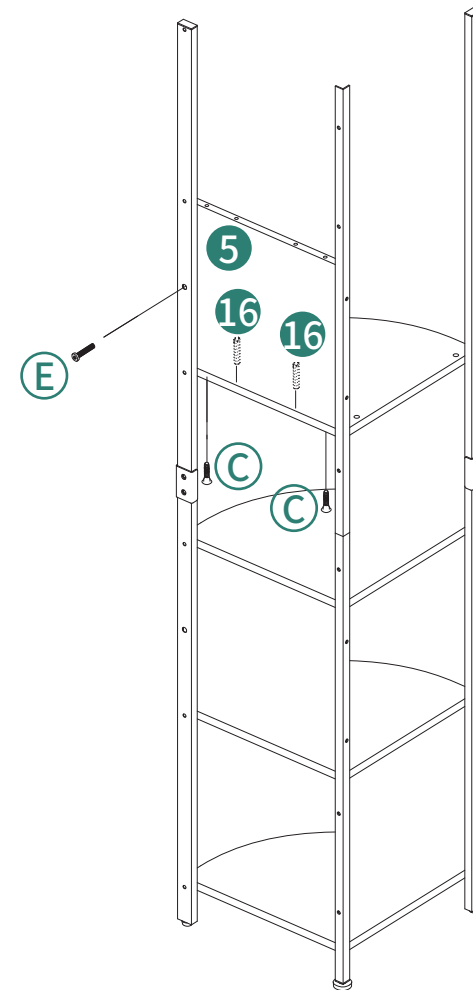

14

ASSEMBLY INSTRUCTIONS

11

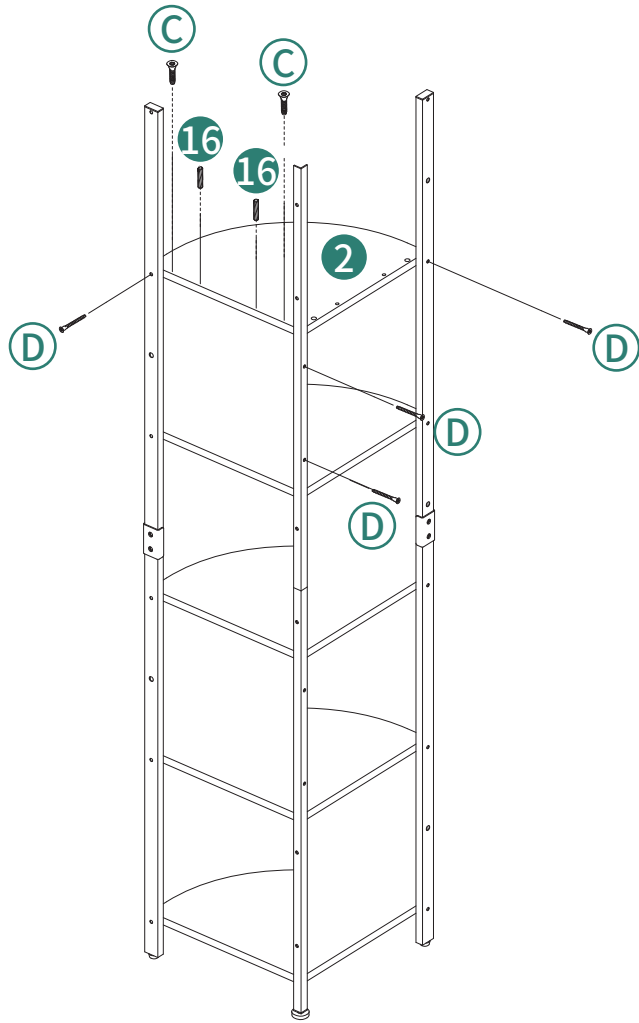
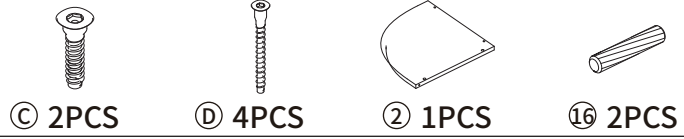

15

ASSEMBLY INSTRUCTIONS

12

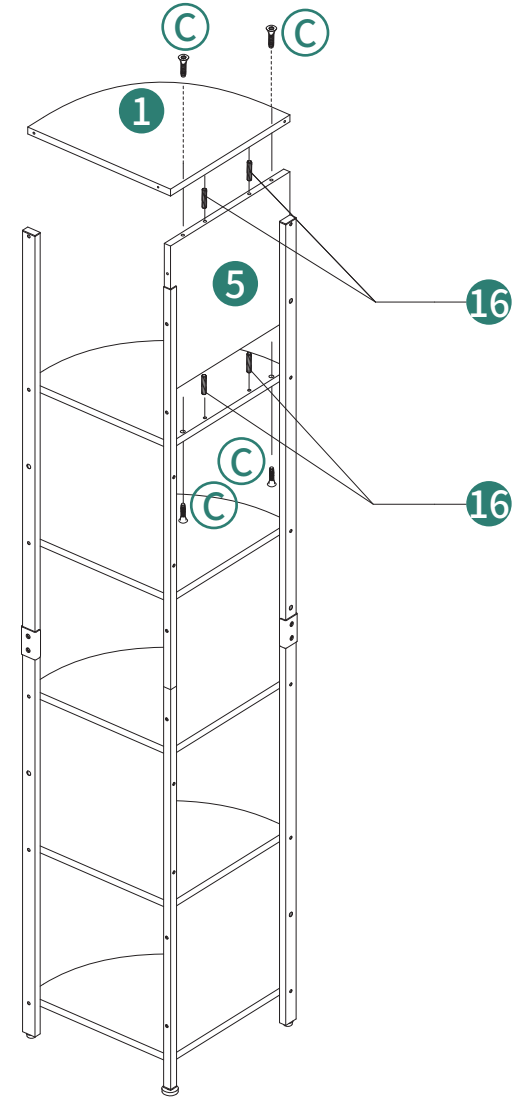
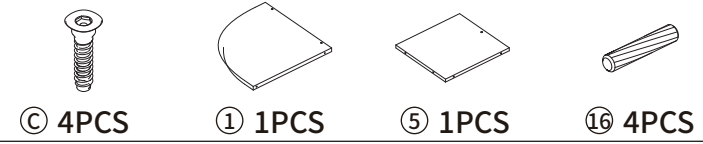

16

ASSEMBLY INSTRUCTIONS

13



ⓓ 4PCS



ⓔ 1PCS

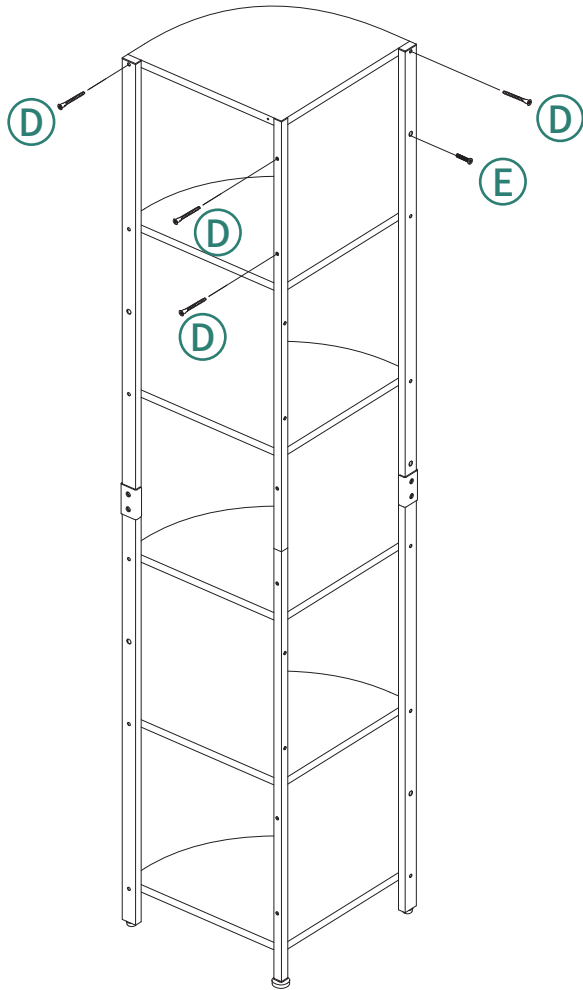

17

ASSEMBLY INSTRUCTIONS



Attention: For safety and stability, we suggest you have to secure the anti-tip accessories to the wall to prevent tipping, injury, and property damage.

14

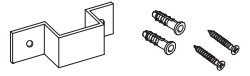

ⓔ 2 SETS

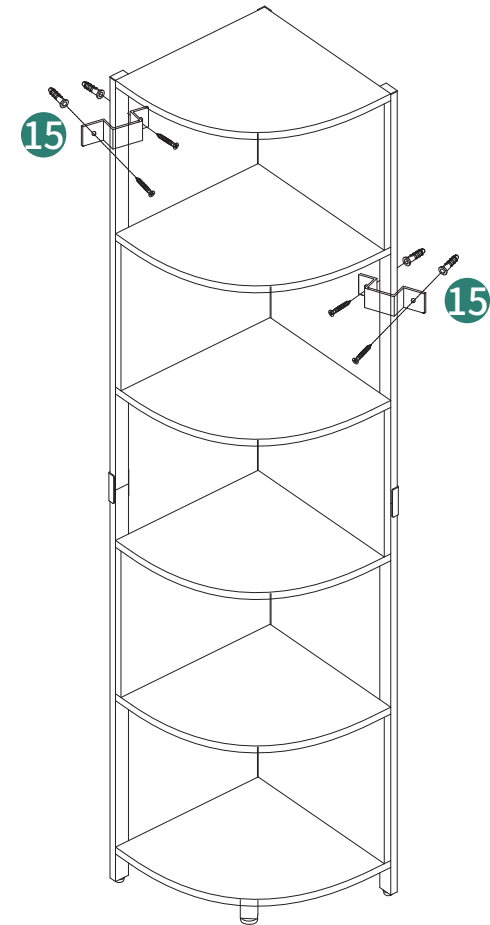

18

Installation Completed