

Manual Book

Crystal Chandelier

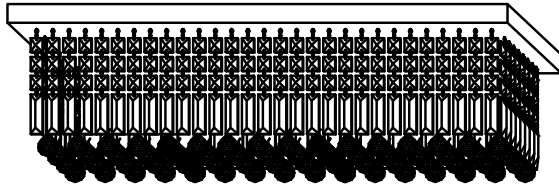

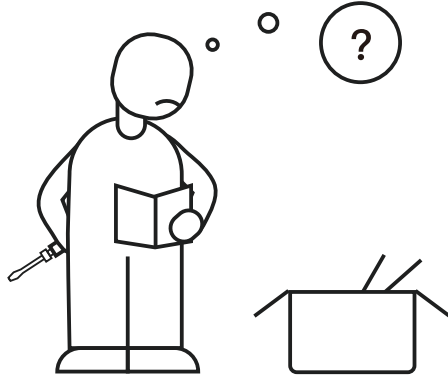

Please contact us with following information:

1. Screen shot of your order page, including product picture, name and order ID number.
2. Problem details with pictures and short videos if possible.

Packing List

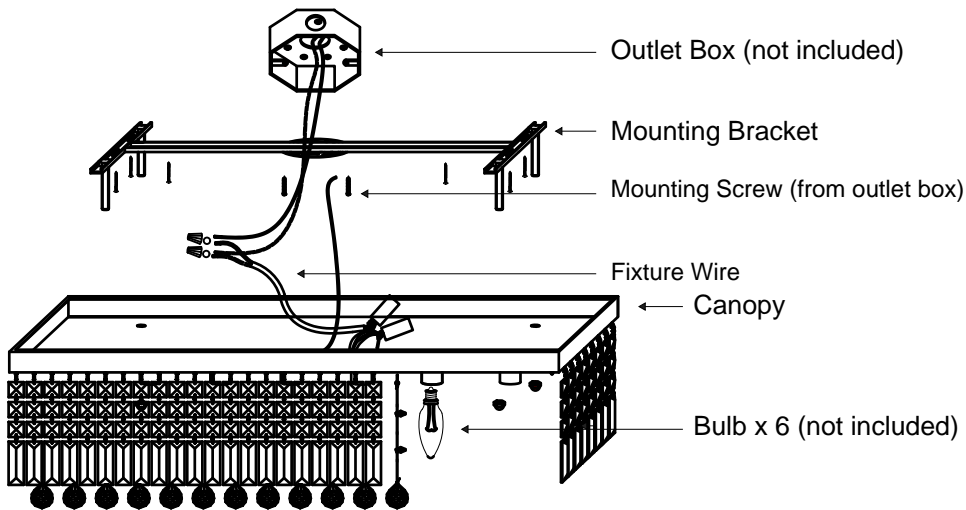

Strand #1 Strand #2 Crystal Ball



x 74



x 64



x 64

NOTE:

1. Crystal is fragile, spare parts included.
2. Some parts may be placed inside the canopy, please take everything out of the box when you check the packing list.
3. **Packing list in the installation video maybe different from this one, please refer to this page.**

Safety Rules

WARNING: BE SURE THE ELECTRICITY TO THE WIRES YOU ARE WORKING ON IS SHUT OFF; EITHER THE FUSE IS REMOVED OR THE CIRCUIT BREAKER IS TURNED OFF. TURNING THE POWER OFF USING THE LIGHT SWITCH IS NOT SUFFICIENT TO PREVENT ELECTRICAL SHOCK.

NOTE: The important safeguards and instructions appearing in this manual are not meant to cover all possible conditions or situations that may occur. It must be understood that common sense, caution, and care, are factors which cannot be built into any product. These factors must be supplied by the person(s) installing this unit.

READ & SAVE THESE INSTRUCTIONS

CAUTION: Before assembling the lighting fixture, refer to the section titled Wiring Connections. If you feel you do not have enough electrical wiring experience, either refer to a do-it-yourself wiring handbook or have your lighting fixture installed by a qualified, licensed electrician.

UNPACK THE PACKAGE

Check the contents to be sure everything is included

Tools Needed: Slotted screwdriver, Adjustable wrench, Step ladder, Wire cutters, wiring supplies as required by electrical code.

INSTALLATION & OPERATION INSTRUCTIONS GENERAL

Before starting the installation, disconnect the power by turning off the circuit breaker or by removing the appropriate fuse at the fuse box. Turning the power off using the light switch is not sufficient to prevent electrical shock.

All electrical connections must be in accordance with local and National Electrical Code (NEC) standards. If you are unfamiliar with proper electrical wiring connections, obtain the services of a qualified electrician.

Remove the fixture and the mounting packages from the box and make sure that no parts are missing by referencing the illustrations on the installation instructions.

Be sure to read these installation instructions and review the diagrams thoroughly before installation.

LIGHT BULBS REQUIRED

This fixture uses E12 bulb base, works with halogen and LED bulbs up to 40W each. Fully dimmable when used with dimmable bulbs and a compatible dimmer switch (not included).

BULBS ARE NOT INCLUDED IN THIS ITEM. Please purchase the right bulbs you need.

1. Installation Preparation

Tools You Need



Ladder

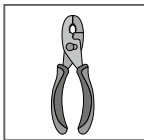

Pliers

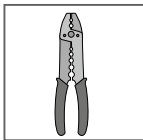

Wire Strippers

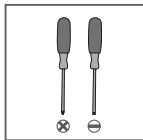

Screwdrivers

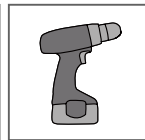

Power Drill (optional)



Drill Bit (optional)

If mounting to a support structure, you will also need the optional tools.

2. Mounting And Wiring

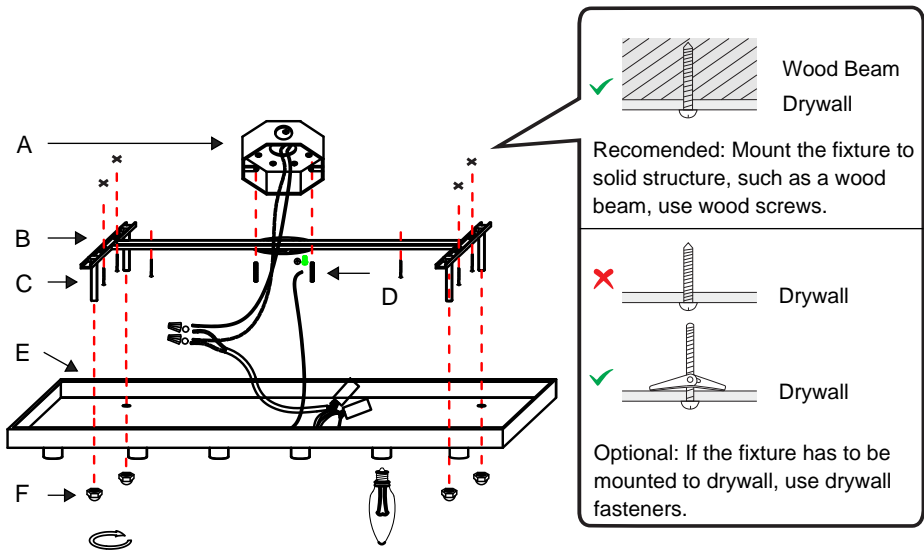
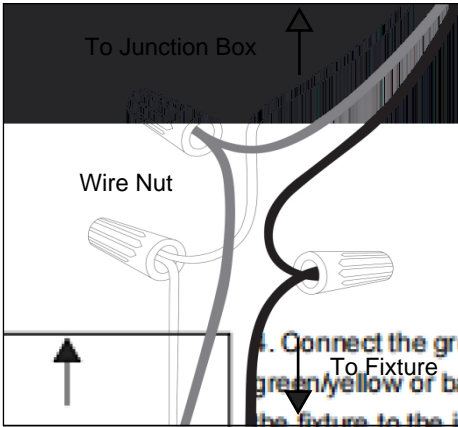

Fig. 1

1. Carefully remove all parts from the box and remove all plastic coverings.
2. Loosen the cap nut (F) from canopy (E) and remove mounting plate (B).
3. Attach the mounting plate (B) to the ceiling with mounting screws (D) and other proper fasteners from your local hardware store (Fig. 1).

- ※ Junction box and mounting screws are not included.
- ※ Make sure the ceiling have the capacity of the weight of the fixture.
- ※ Fixture must be installed according to applicable code (s) by a person familiar with its construction and operation. If unsure, contact a licensed electrician.



4. Connect the ground wire (green, green/yellow or bare copper) from the fixture to the junction box ground wire with a plastic wire nut, wrap the connection with electrical tape.

5. Connect the neutral wire (white or blue) to the junction box neutral wire with a plastic wire nut and wrap the connection with electrical tape.

6. Connect the neutral wire (black or brown) to the junction box hot wire with a plastic wire nut and wrap the connection with electrical tape.

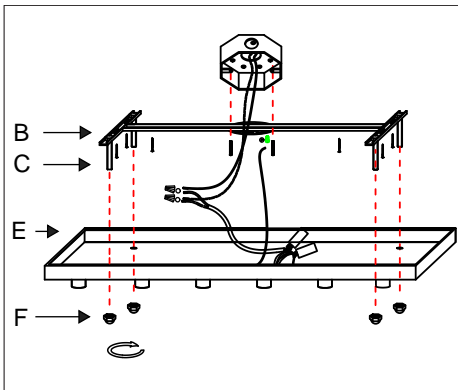

7. Attach canopy (E) to the affixed mounting plated (B). Pass connection rods (C) through the holes on canopy (E) and secure with cap nuts (F).

8. Restore power to junction box and check operation of fixture.

9. Tear off the protective film above canopy (E).

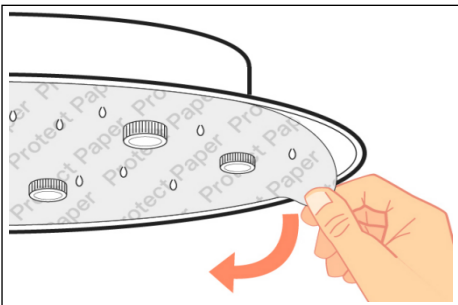

※ Prevent accidentally discarding small parts or hardware. Retain all carton contents until assembly and installation are complete.

3. Fixture Assembly

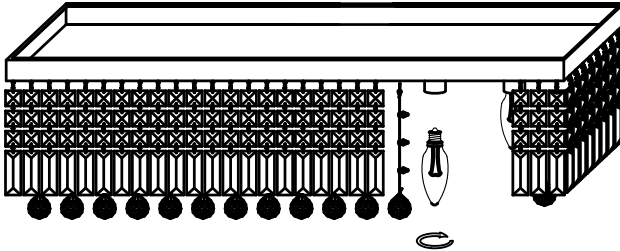

Strand #1 Strand #2 Crystal Ball



1. Peel off the protective film above the canopy.
2. Install light bulbs (E12 x 6, Max 40W each, LED recommended).
3. Connect the crystal ball onto crystal strand #2 (see page 8), and hang the crystal strand onto the canopy per the drawing above.
4. Hang crystal strand #1 onto the outer layer of the canopy, be sure the flat side of the rectangle crystal facing inwards of the fixture.

4. Assembly Details

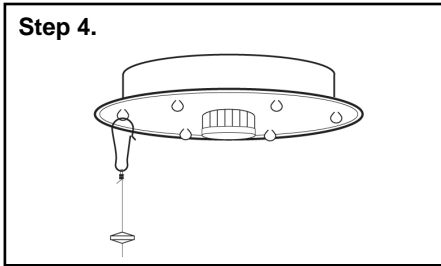
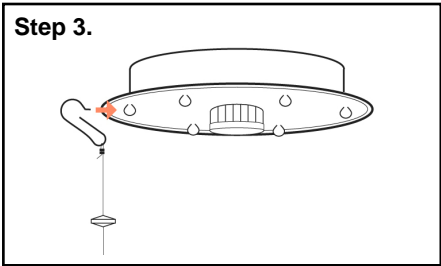
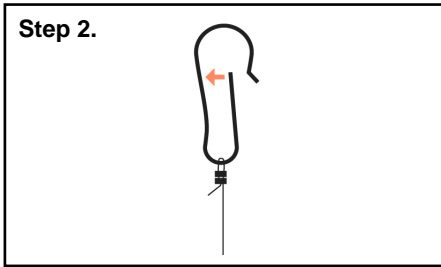
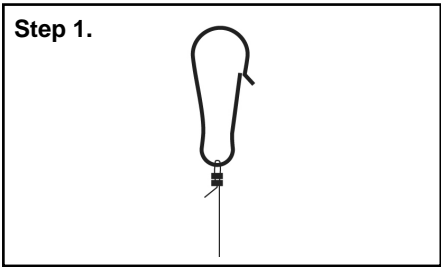
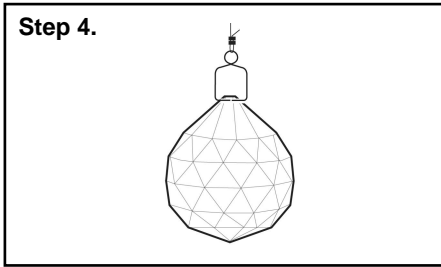
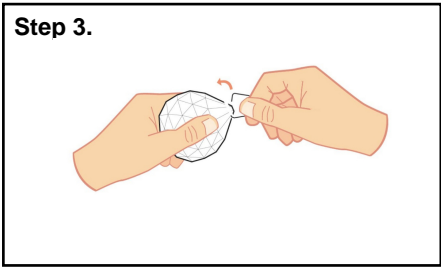
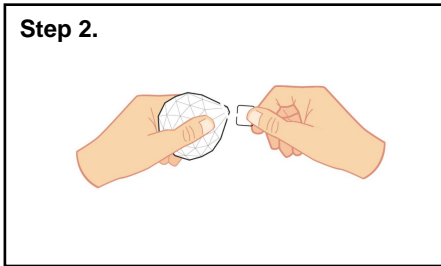
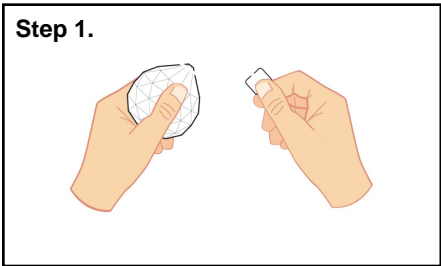

DIY Strand if Needed

Tools and Accessories You Need

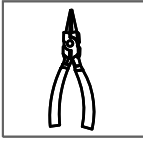

Pliers
(not included)

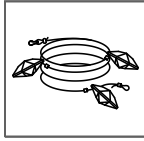

Stainless
Wire

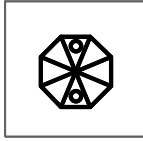

Crystal
Bead



Oval Clip

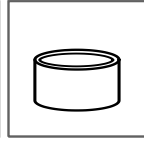

Location Clip

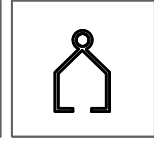

Triangle Clip

※ Please DIY the crystal strands if it comes with missing or damaged ones during shipping or installation.

How To DIY A Crystal Strand:

Step 1. Hang the stainless wire onto the canopy in the target position.

Step 2. Pass the stainless wire through crystal bead and location clip alternately with the proper quantity of them.

Step 3. Fix the location clips onto the wire one by one by comparing the nearby crystal strand's rules. Make sure the crystal bead is on the upper side of the clip.

Step 4. Fix the bottom clip onto the wire and hang a triangle clip on it.

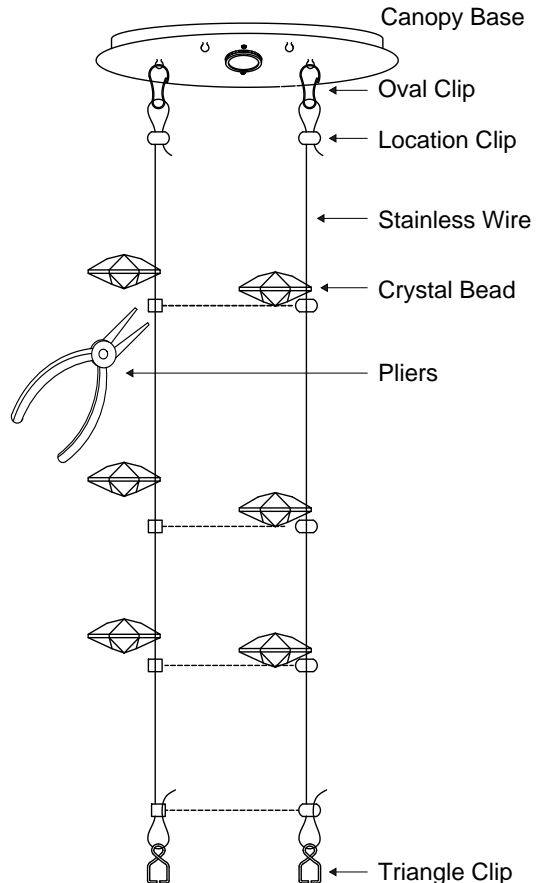

Trouble Shooting

1. Missing/broken Parts

- DIY the crystal strands if needed to get them installed sooner, rather than waiting weeks for the replacement (page 9).
- Make a list of the missing/broken parts according to the packing list, take photos of broken parts, then email us for free replacements.

2. Bulbs Do Not Light Up / Flicker / Noisy Operation

- Check your power and switch to make sure it's power on.
- Check the bulb to make sure it's installed correctly.
- Change a new bulb.
- Check the wires to make sure they are connected correctly.
- Make sure your bulb is dimmable if you use a dimmer switch.

3. Could Not Install

- Take photos of the ceiling, and contact the seller for technical support.

Clean And Care

To clean, wipe fixture with a soft cloth. Spray from chemical cleaners can discolor the finish of fixture. Do not use scouring pads, powders, steel wool, or abrasive paper to clean this fixture.

Ordering Parts

Keep this manual for future reference, and in case replacement parts are needed. Available parts can be ordered from the place of purchase. Use exact wording from diagrams when ordering parts.