

**MODEL:IG10600041C-N**

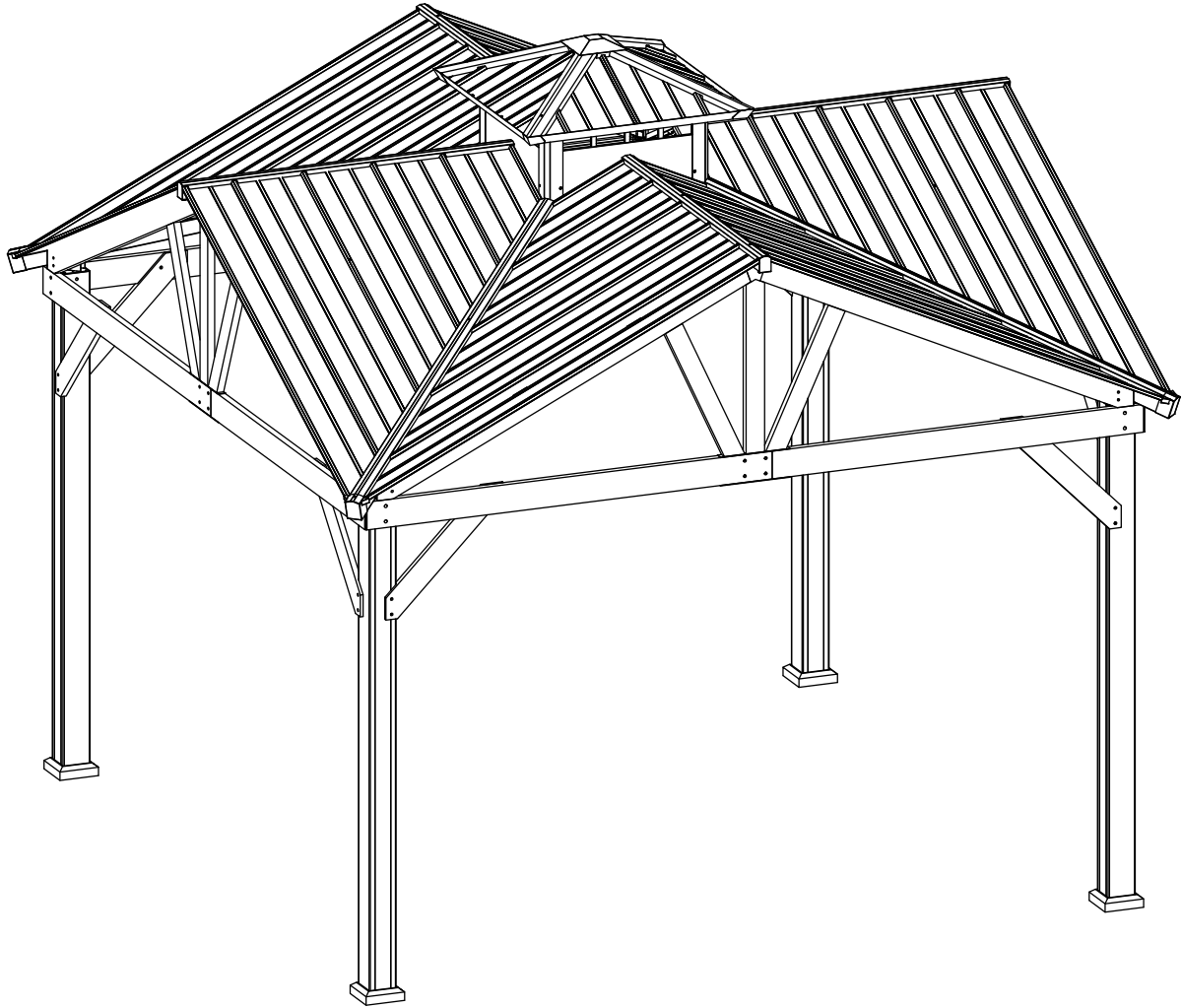

OWNER'S MANUAL



# 12'X12'Wedge wood Cedar Framed Hard Top Gazebo

**TABLE OF CONTENTS**

**ASSEMBLY GUIDE**.....02  
**USING YOUR PRODUCE**.....05











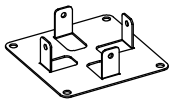
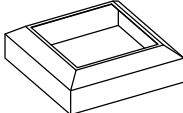
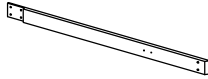

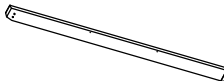
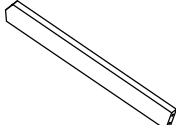
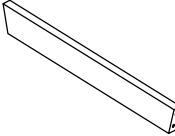
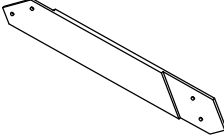
January 27, 2026

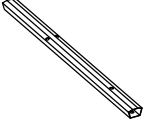
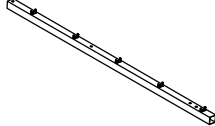

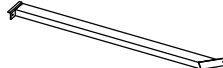
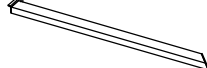
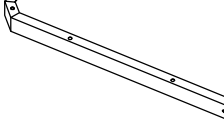
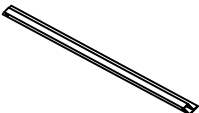
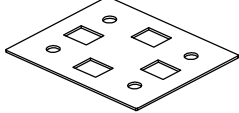

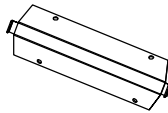
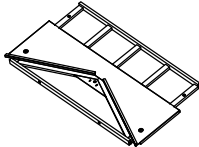
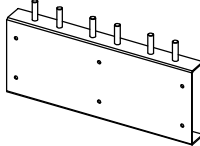
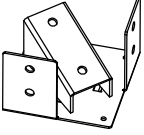
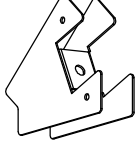
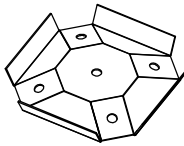
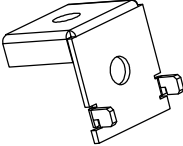
**QUESTIONS?**

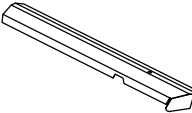
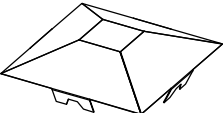
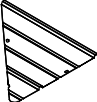
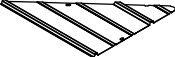
-  **E-mail:** [support@modernshade.org](mailto:support@modernshade.org)
-  **Toll Free Number:** 1-888-666-3070
-  **Mon-Fri:** 9:00 AM - 5:00 PM PST.



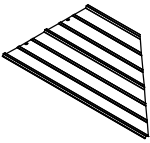
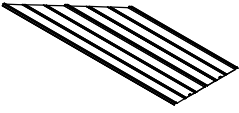
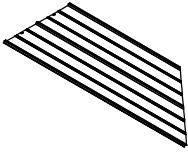

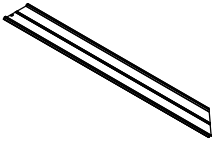

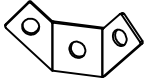

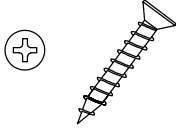
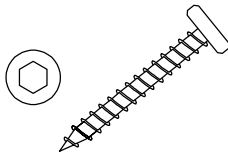
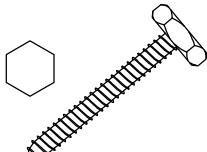
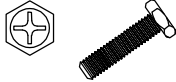
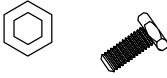

# ASSEMBLY GUIDE

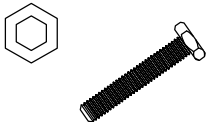
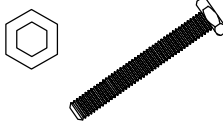
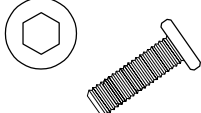
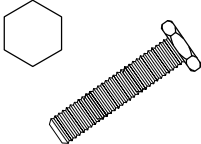
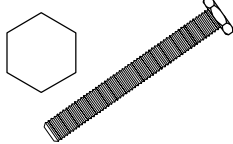
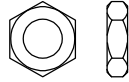
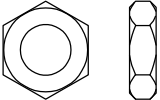
## PARTS LIST

<b>A</b> Post (4 Piece) 	<b>B</b> Foot Base (4 Piece) 	<b>C</b> Foot Cover (4 Piece) 	<b>D1</b> Cross Beam 1 (4 Piece) 	<b>D2</b> Cross Beam 2 (4 Piece) 	<b>E1</b> Herringbone Beam 1 (4 Piece) 
P0008008604-B	P0008008605	P0008008606	P0008008607-B	P0008008608-B	P0008008609-B
<b>E2</b> Herringbone Beam 2 (4 Piece) 	<b>F1</b> Herringbone Support Bracket 1 (4 Piece) 	<b>F2</b> Herringbone Support Bracket 2 (8 Piece) 	<b>G1</b> Support Bracket 1 (4 Piece) 	<b>G2</b> Support Bracket 2 (4 Piece) 	<b>H1</b> Roof Rib 1 (4 Piece) 
P0008008610-B	P0008008611-B	P0008008612-B	P0008008613-B	P0008008614-B	P0008008615
<b>H2</b> Roof Rib 2 (4 Piece) 	<b>K</b> Middle Cross Beam (4 Piece) 	<b>L1</b> Roof Support 1 (4 Piece) 	<b>L2</b> Roof Support 2 (4 Piece) 	<b>L3</b> Roof Support 3 (4 Piece) 	<b>L4</b> Roof Support 4 (4 Piece) 
P0008008616	P0008008617	P0008008618	P0008008619	P0008008620	P0008008621
<b>M1</b> Roof Top Support 1 (4 Piece) 	<b>M2</b> Roof Top Support 2 (4 Piece) 	<b>N</b> Cross Beam Connector (4 Piece) 	<b>P</b> Roof Rib Connector (4 Piece) 	<b>Q1</b> Protector 1 (4 Piece) 	<b>Q2</b> Protector 2 (4 Piece) 
P0008008622	P0008008623	P0008008624	P0008008625	P0008008626	P0008008627
<b>R1</b> Connector 1 (4 Piece) 	<b>R2</b> Connector 2 (4 Piece) 	<b>R3</b> Connector 3 (4 Piece) 	<b>R4</b> Connector 4 (1 Piece) 	<b>R5</b> Connector 5 (4 Piece) 	<b>S1</b> Roof Rib Cover 1 (4 Piece) 
P0008008628	P0008008629	P0008008630	P0008008498	P0008008632	P0008008633
<b>S2</b> Roof Rib Cover 2 (4 Piece) 	<b>S3</b> Roof Rib Cover 3 (4 Piece) 	<b>S4</b> Roof Rib Cover 4 (1 Piece) 	<b>T1</b> Roof Plate 1 (4 Piece) 	<b>T2</b> Roof Plate 2 (4 Piece) 	<b>T3</b> Roof Plate 3 (4 Piece) 
P0008008634	P0008008635	P0008008505	P0130010999	P0130011099	P0130011199

<p><b>T4</b> Roof Plate 4 (4 Piece)</p> 	<p><b>T5</b> Roof Plate 5 (4 Piece)</p> 	<p><b>T6</b> Roof Plate 6 (4 Piece)</p> 	<p><b>T7</b> Roof Plate 7 (4 Piece)</p> 	<p><b>T8</b> Roof Plate 8 (4 Piece)</p> 	<p><b>U</b> Hook (1 Piece)</p> 
<p>P0130011299</p>	<p>P0130011399</p>	<p>P0130011499</p>	<p>P0130011599</p>	<p>P0130011699</p>	<p>P0008008594</p>
<p><b>R6</b> Connector 6 (4 Piece)</p>  <p>P0008008636</p>					

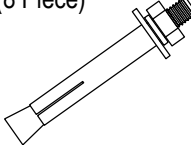
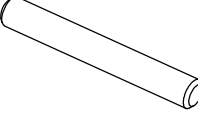
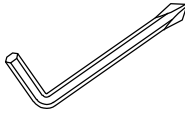
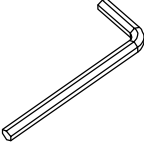
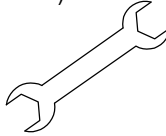
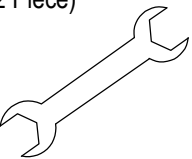
# HARDWARE

<b>AA</b> Bolt M5*25 (96+5 Piece) 	<b>BB</b> Bolt M8*35 (32+2 Piece) 	<b>CC</b> Bolt M10*65 (8+1 Piece) 	<b>DD</b> Bolt M5*30 (8+1 Piece) 	<b>EE</b> Bolt M6*15 (96+6 Piece) 	<b>FF</b> Bolt M6*25 (16+1 Piece) 
H0008008098	H0008008099	H0008008100	H0008008101	H0008008001	H0008008102
<b>GG</b> Bolt M6*45 (20+2 Piece) 	<b>HH</b> Bolt M6*55 (4+1 Piece) 	<b>JJ</b> Bolt M8*30 (16+1 Piece) 	<b>KK</b> Bolt M8*50 (16+1 Piece) 	<b>LL</b> Bolt M10*170 (8+1 Piece) 	<b>MM</b> Screw Nut M8 (16+1 Piece) 
H0008008016	H0008008103	H0008008104	H0008008105	H0008008106	H0008008088
<b>NN</b> Screw Nut M10 (8+1 Piece) 	<b>OO</b> M5 Flat washer (8+1 Piece) 	<b>PP</b> M6 Flat washer (136+8 Piece) 	<b>QQ</b> M8 Flat washerr (80+4 Piece) 	<b>RR</b> M10 Flat washer (24+2 Piece) 	<b>SS</b> M5 Sealant Washer (8+1 Piece) 
H0008008107	H0008008056	H0008008057	H0008008058	H0008008108	H0008008059
<b>TT</b> M6 Sealant Washer (28+2 Piece) 	<b>UU</b> Concrete Anchor M6*60 (8 Piece) 	<b>VV</b> Bolt Pin (24 Piece) 	<b>WW</b> M6 Allen Key with Screw Driver (2 Piece) 	<b>XX</b> M8 Allen Key (2 Piece) 	<b>YY</b> Double Open End Wrench M6/M8 (2 Piece) 
H0008008060	H0008008095	H0008008109	H0008008132	H0008008073	H0008008062
<b>ZZ</b> Double Open End Wrench M10 (2 Piece) 	<b>JJM</b> Nut M8 (16+1 Piece) 				
H0008008110	H0008008111				

## IMPORTANT:

This instruction manual contains important information necessary for the proper assembly and safe use of the product.

Read and follow all warnings and instructions before assembling and using the product.

Follow all warnings and instructions when using the product.

Keep this manual for future reference.

Installer/Assembler: leave these instructions with the consumer.

## SAFETY ALERT KEY

### DANGER

Indicates a hazardous situation that, if not avoided, will result in death or serious injury.

### WARNING

Indicates a hazardous situation that, if not avoided, could result in death or serious injury.

### CAUTION

Indicates a hazardous situation that, if not avoided, could result in minor or moderate injury.

### NOTICE

Indicates information considered important, but not hazard-related (e.g. messages related to property damage).

# ASSEMBLY INSTRUCTIONS

•Please carefully unpack each of the components and hardware, check the components against the parts list and make sure there are no missing parts. lay pieces on cardboard or a soft mat to help protect the pieces from scratches.

## ⚠ CAUTION

Watch for sharp edges when handling the pieces, wear gloves to avoid injury.

**STEP 01** Use four (4) [AA] bolts to attach foot base **B** and foot Cover **C** to post **A**. Repeat with the other three (3) post **A**.

[AA] x16

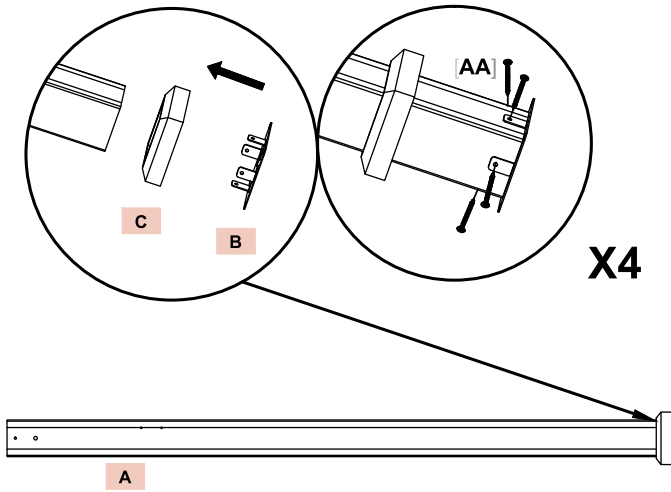

**STEP 03** Use six (6) [AA] bolts to attach one (1) connector 1 **R1** to cross beam assemblies **D1 D2**. Repeat with the other three (3) cross beam assemblies **D1 D2**.

[AA] x40

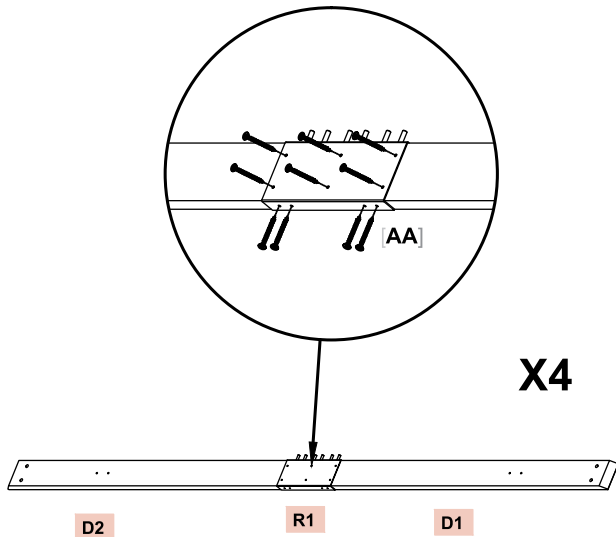

- For ease of assembly, it is recommended to have 3 or more people and allow enough time to completely finish the assembly. assembly can take 6-8 hours. a step-ladder is required for assembly (not included).
- Follow step by step instructions, and follow all safety warnings provided with your tools.
- DO NOT tighten screws until all the screws and washers are properly installed. Tighten screws securely, do not over tighten.
- Gazebo should not be used in inclement weather and high winds.

**STEP 02** Attach four (4) [JJM] nuts to one (1) cross beam 2 **D2**. Use four (4) [JJ] bolts and four (4) [QQ] flat washers to attach one (1) cross beam **D1** and **D2** to cross beam connector **N**. Repeat with the other three (3) cross beam **D1** and **D2**.

[JJ] x16

[QQ] x16

[JJM] x16

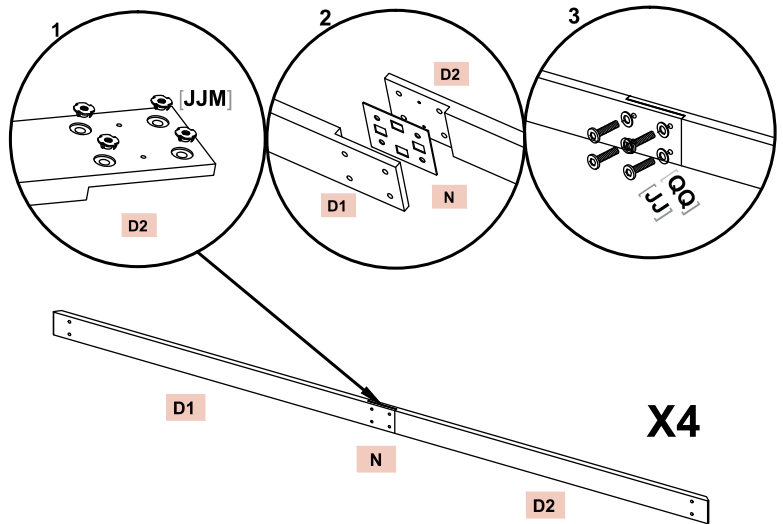

**STEP 04** Use two (2) [CC] bolts, two (2) [LL] bolts, two (2) [NN] screw nuts and six (6) [RR] flat washers to attach one (1) cross beam assemblies **D1 D2** to posts **A**. Repeat with the other cross beam assemblies **D1 D2** and posts **A**.

[CC] x4

[LL] x4

[NN] x4

[RR] x12

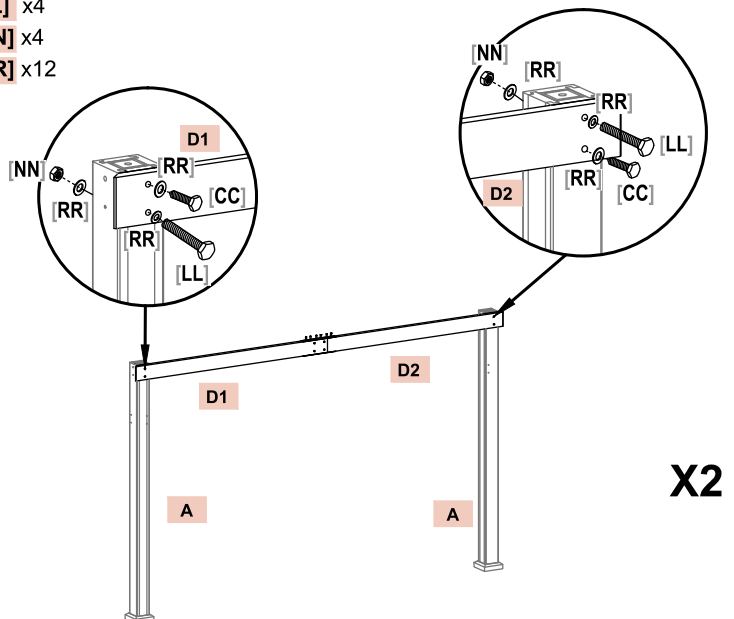

**STEP 05** Use two (2) [CC] bolts, two (2) [LL] bolts, two (2) [NN] screw nuts and six (6) [RR] flat washers to attach one (1) cross beam assembly [D1] [D2] to posts [A]. Repeat with the other cross beam assembly [D1] [D2] to posts [A].

- [CC] x4
- [LL] x4
- [NN] x4
- [RR] x12

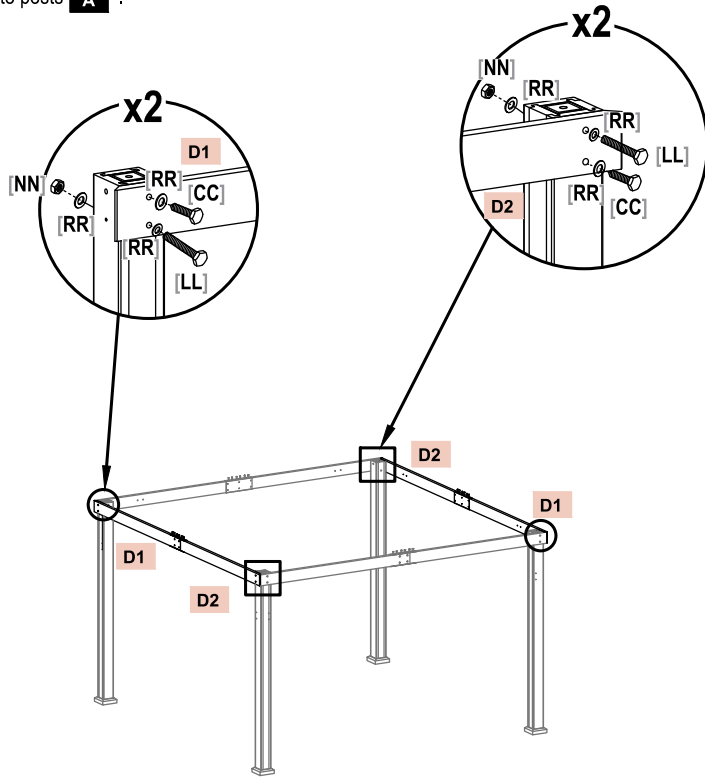

**STEP 06 CRITICAL: SQUARE UNIT BEFORE PROCEEDING TO NEXT STEPS. ONCE SQUARE, TIGHTEN ALL HARDWARE.**

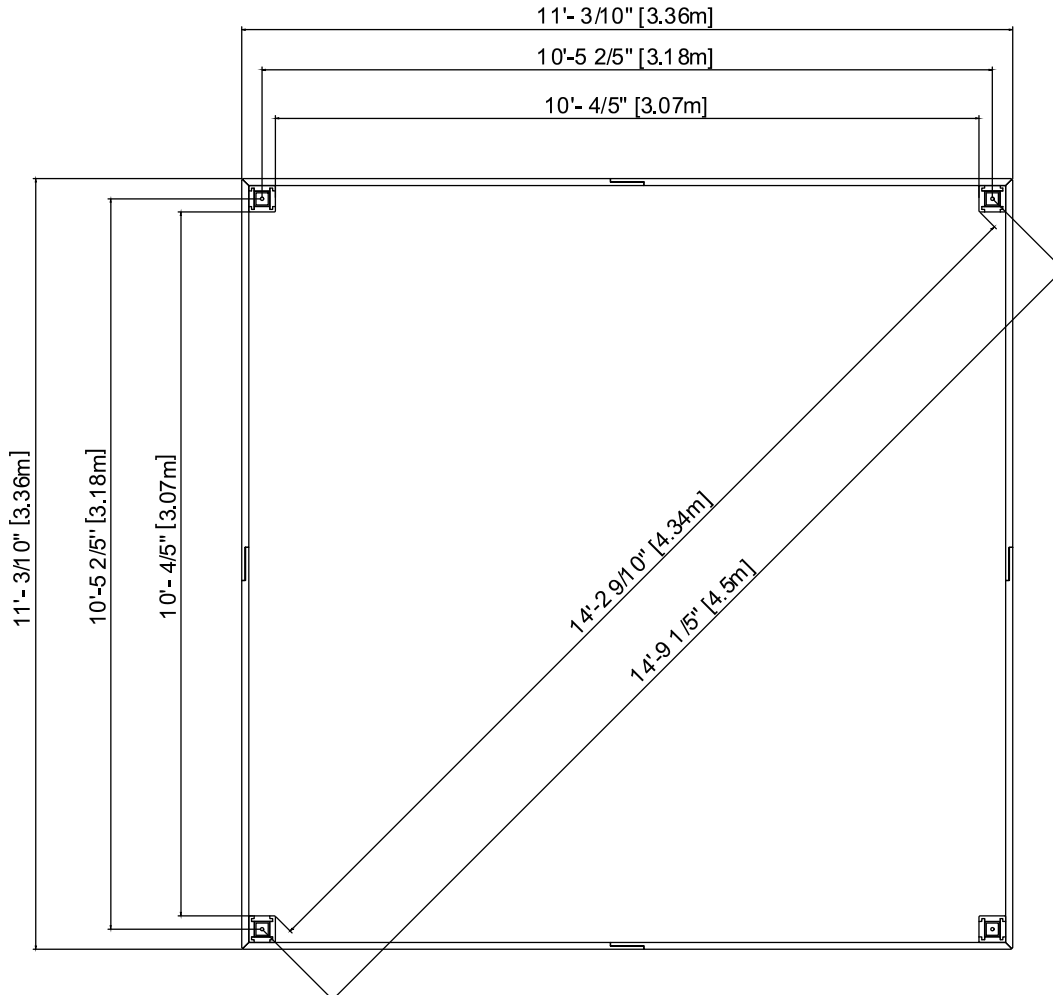

**STEP 07** Use four (4) **[BB]** bolts and four (4) **[QQ]** flat washers to attach one (1) support bracket 1 **[G1]** to cross beam assembly **[D1]** **[D2]** to posts **[A]** .  
 Use four (4) **[BB]** bolts and four (4) **[QQ]** flat washers to attach one (1) support bracket 2 **[G2]** to cross beam assembly **[D1]** **[D2]** to posts **[A]** .  
 Repeat with the other three (3) support bracket **[G1]** and **[G2]** .

**[BB]** x32

**[QQ]** x32

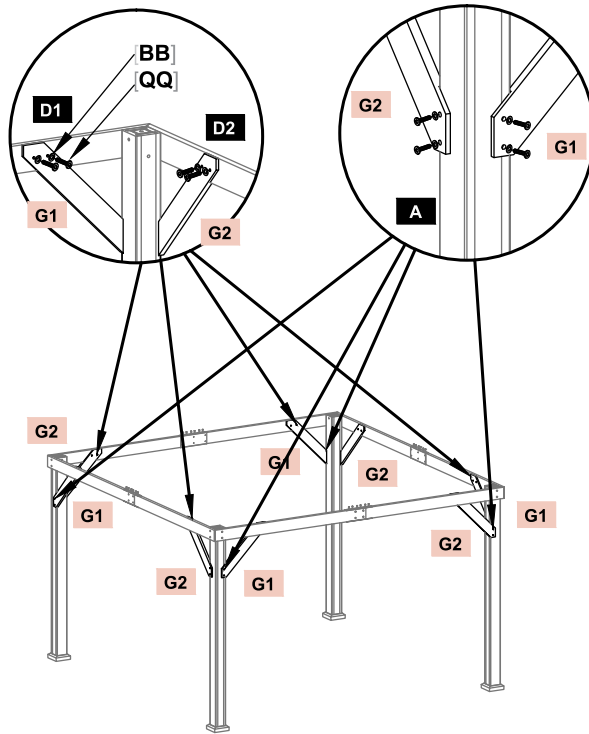

**STEP 08** Use four (4) **[AA]** bolts to attach one (1) connector 2 **[R2]** to post **[A]** .  
 Repeat with the other three (3) connector **[R2]** .

**[AA]** x16

**STEP 09** Attach one (1) herringbone support bracket 1 **[F1]** and two (2) herringbone support bracket 2 **[F2]** to cross beam assembly **[D1]** **[D2]** .  
 Repeat with the other three (3) herringbone support bracket **[F1]** and six (6) herringbone support bracket **[F2]** .

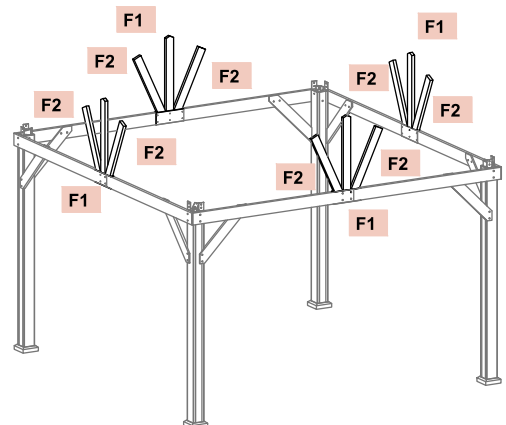
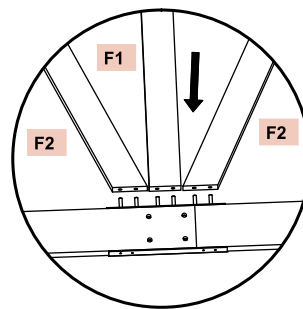
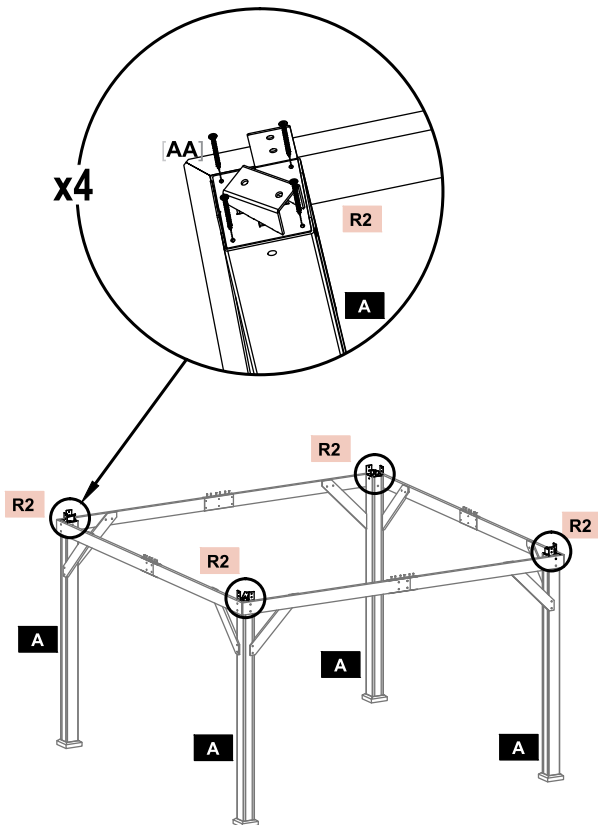

**STEP 10** Attach six (6) [VV] bolt pins to herringbone support bracket [F1] and [F2]. Repeat with the other eighteen (18) [VV] bolt pins.

[VV] x24

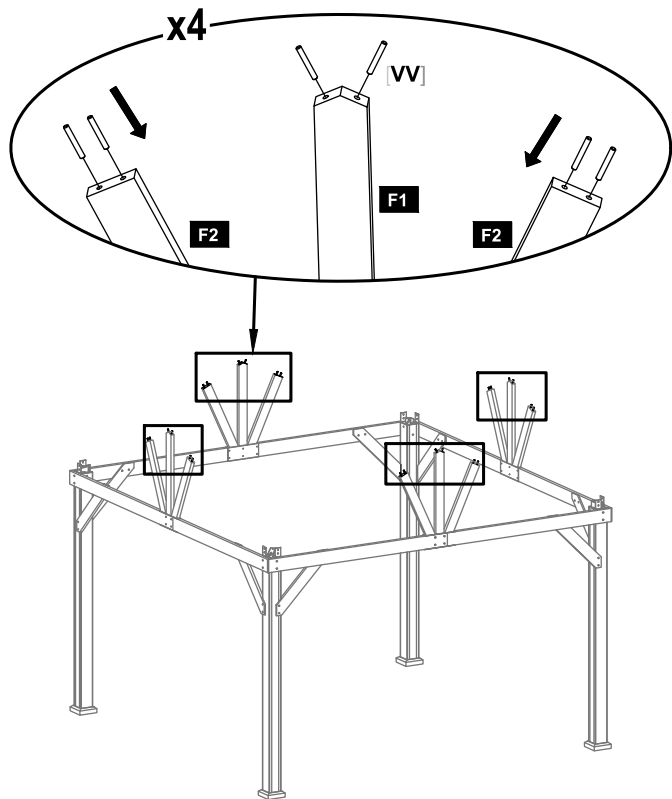

**STEP 11** Attach herringbone beam [E1] and [E2] to herringbone support bracket [F1] and [F2]. Use two (2) [KK] bolts, two (2) [MM] screw nuts and four (4) [QQ] flat washers to attach herringbone beam 1 [E1] to connector [R2]. Use two (2) [KK] bolts, two (2) [MM] screw nuts and four (4) [QQ] flat washers to attach herringbone beam 2 [E2] to connector [R2]. Repeat with the other three (3) herringbone beam [E1] and [E2].

[KK] x16

[MM] x16

[QQ] x32

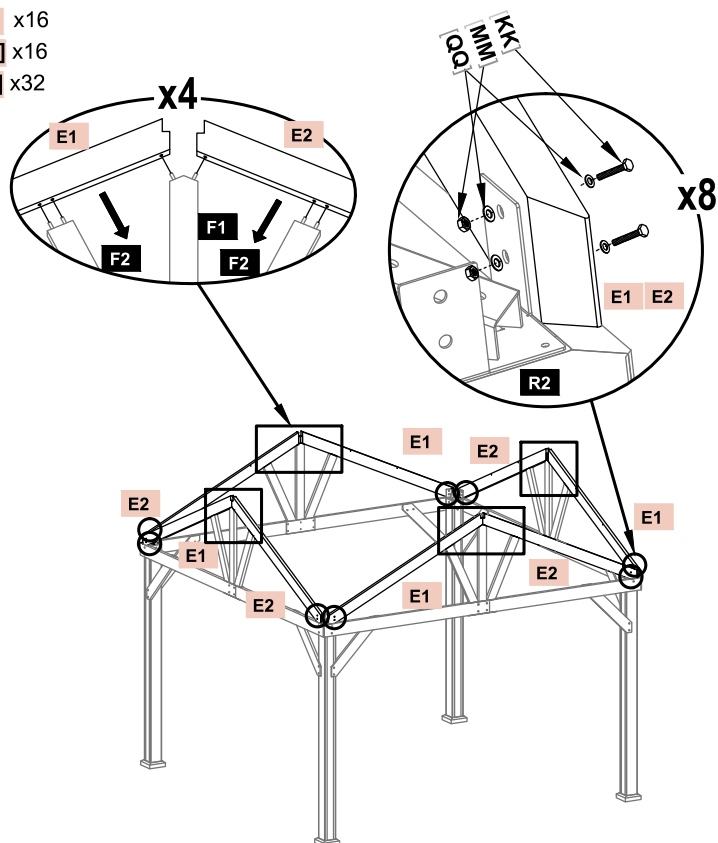

**STEP 12** Use two (2) [AA] bolts to attach one (1) connector 3 [R3] to herringbone beam [E1] and [E2]. Repeat with the other three (3) connector [R3].

[AA] x8

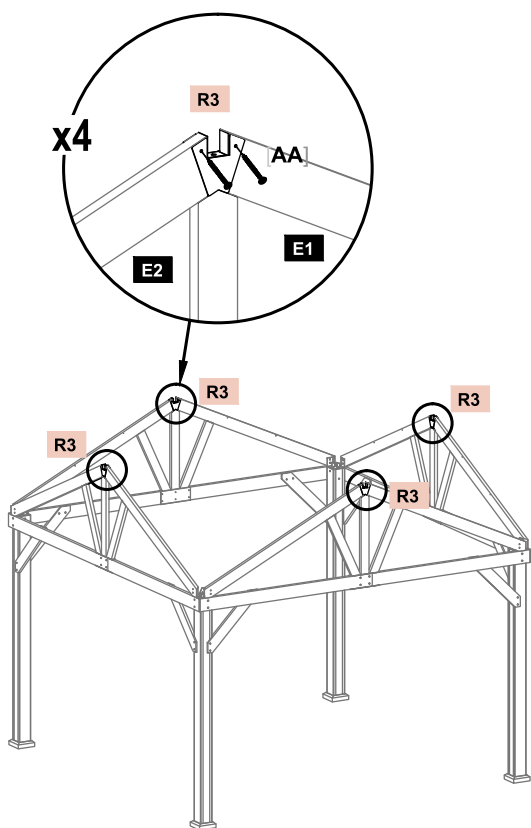

**STEP 13** Use two (2) [EE] bolts and two (2) [PP] flat washers to attach roof rib 1 [H1] to connector [R2]. Repeat with the other three (3) roof rib [H1].

[EE] x8

[PP] x8

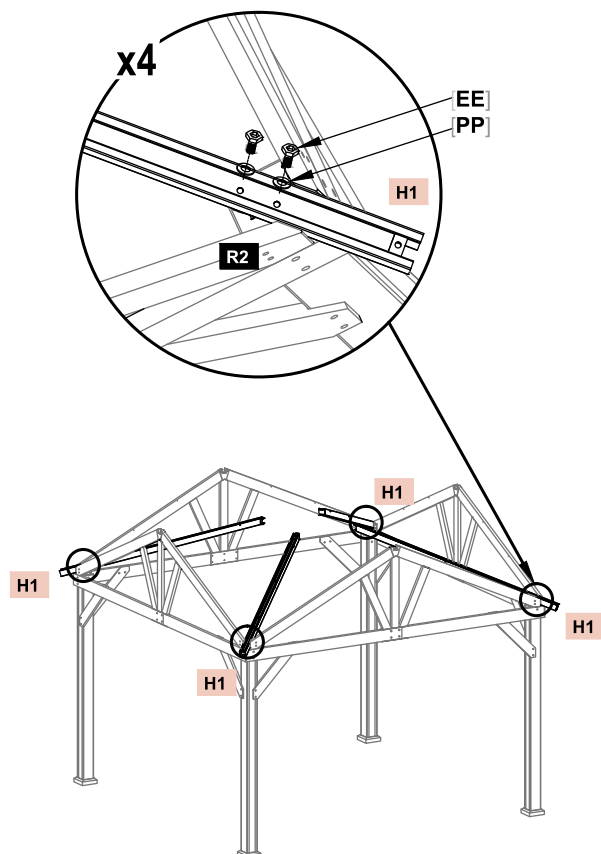

**STEP 14** Use one (1) [EE] bolts and one (1) [PP] flat washers to attach roof top support 1 [M1] with each other.  
Repeat with the other three (3) roof top support [M1].

[EE] x4  
[PP] x4

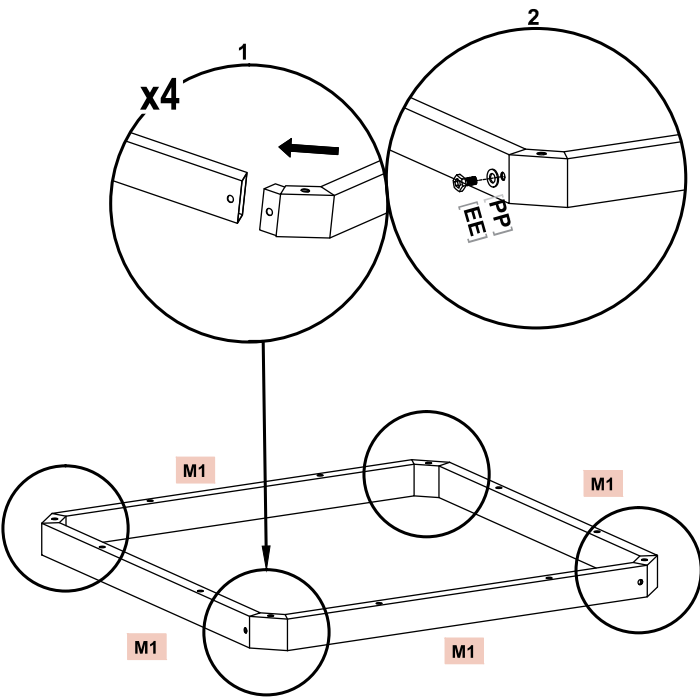

**STEP 15** Use twelve (12) [EE] bolts and twelve (12) [PP] flat washers to attach roof top support assembly [M1] to roof rib [H1].

[EE] x12  
[PP] x12

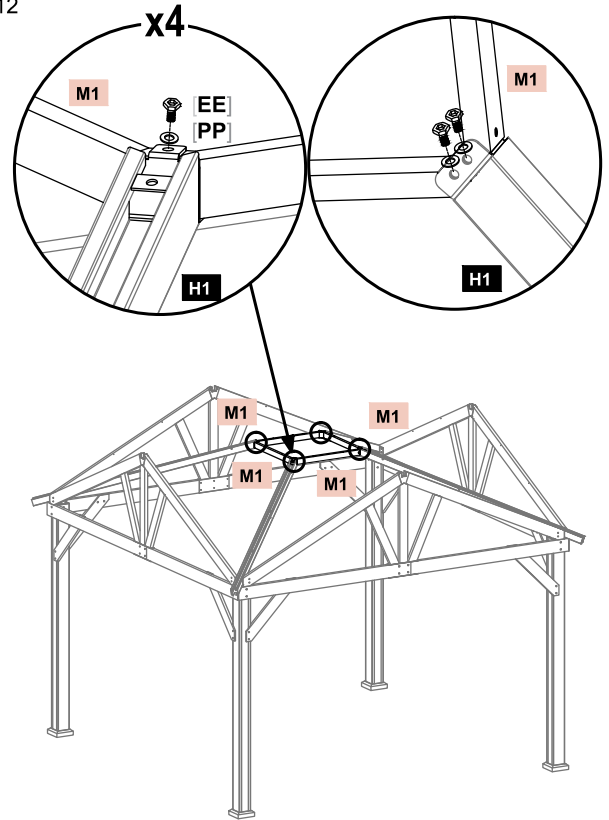

**STEP 16** Use two (2) [FF] bolts and two (2) [PP] flat washers to attach one (1) protector 2 [Q2] to roof top support [M1].  
Repeat with the other three (3) protector [Q2].

[FF] x8  
[PP] x8

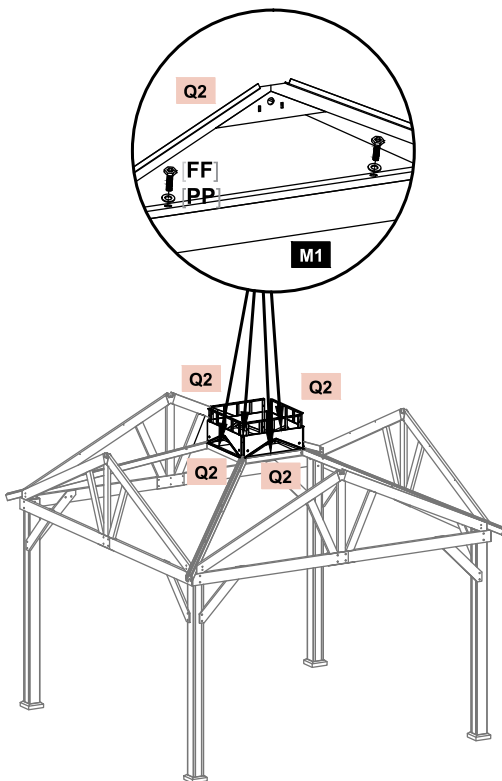

**STEP 17** Use two (2) [EE] bolts and two (2) [PP] flat washers to attach one (1) protector [Q1] to [Q2].  
Repeat with the other three (3) protector [Q1].  
Use three (3) [EE] bolts and three (3) [PP] flat washers to attach one (1) protector [Q1] to roof rib [H1].  
Repeat with the other three (3) protector [Q1].

[EE] x20  
[PP] x20

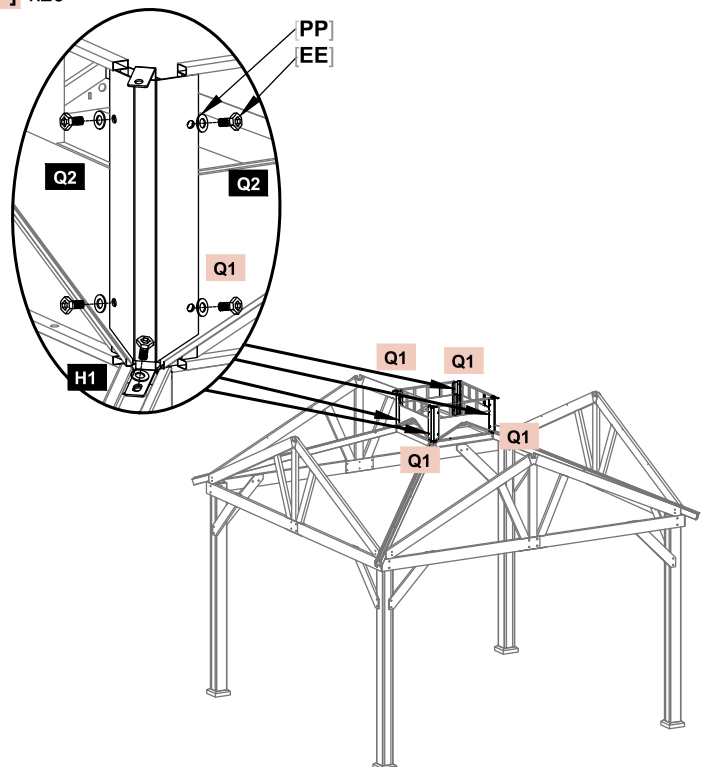

**STEP 18** Use one (1) [EE] bolts and one (1) [PP] flat washers to attach one (1) connector 5 [R5] to protector [Q2]. Repeat with the other three (3) connector [R5].

[EE] x4  
[PP] x4

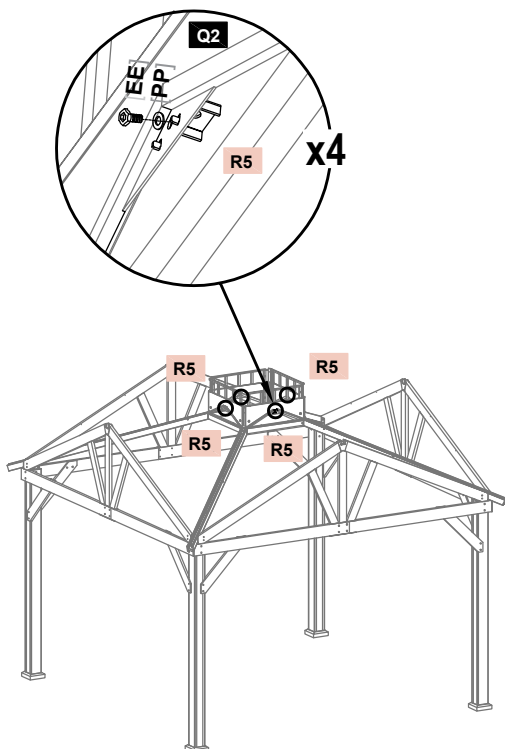

**STEP 19** Use one (1) [EE] bolts and one (1) [PP] flat washers to attach one (1) middle cross beam [K] to connector [R5]. Use one (1) [HH] bolts and one (1) [PP] flat washers to attach one (1) middle cross beam [K] to connector [R3]. Repeat with the other three (3) middle cross beam [K].

[EE] x4  
[HH] x4  
[PP] x8

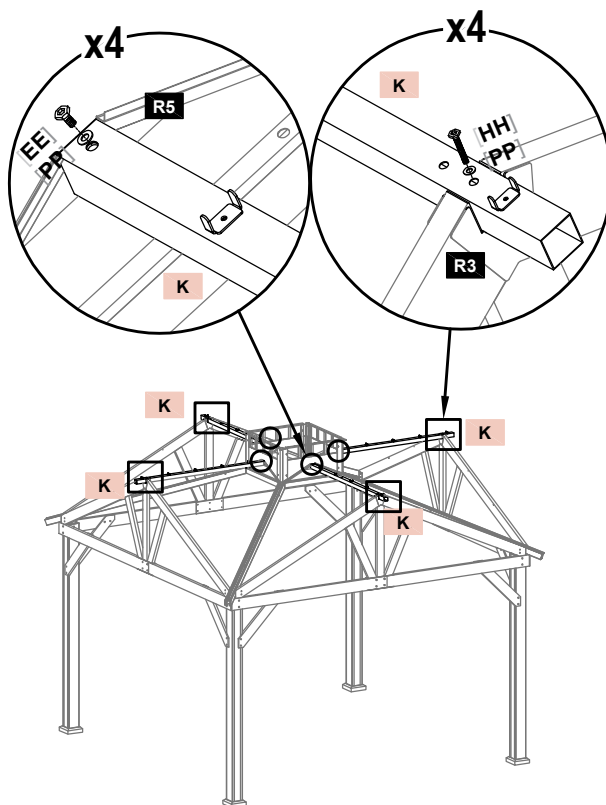

**STEP 20** Use one (1) [EE] bolt and one (1) [PP] flat washer to attach one (1) roof rib 2 [H2] to protector [Q1], then attach the Connector [R6] to the end of roof rib with one (1) [EE] bolt and one (1) [PP] flat washer. Repeat with the other three (3) roof rib [H2].

[EE] x8  
[PP] x8

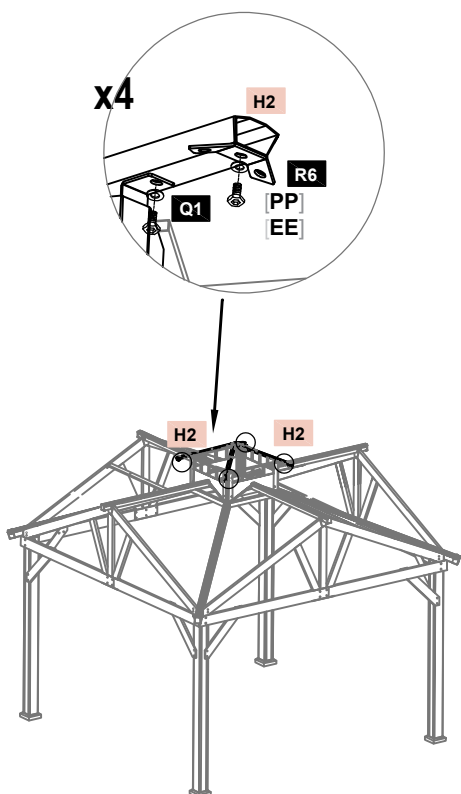

**STEP 21** Use four (4) [EE] bolts and four (4) [PP] flat washers to attach connector 4 [R4] to roof ribs [H2].

[EE] x4  
[PP] x4

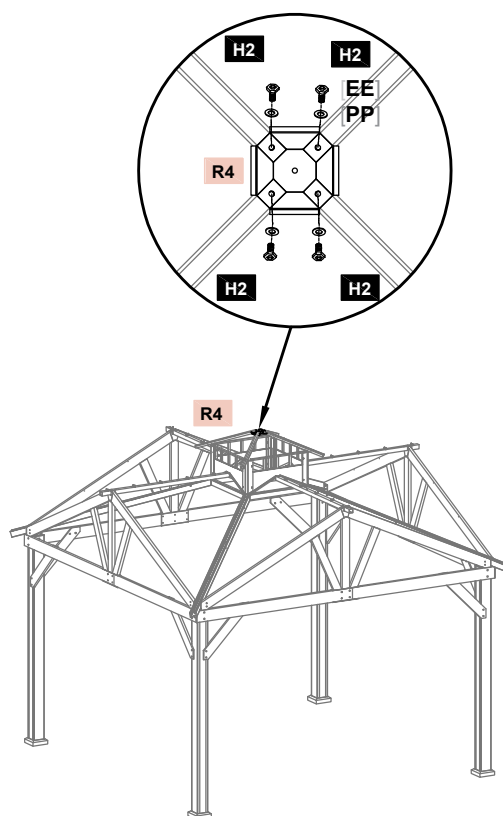

**STEP 22** Use two (2) [FF] bolts and two (2) [PP] flat washers to attach the end of roof top support 2 [M2] to Connector [R6]. Repeat with the other roof top support [M2].

[FF] x8  
[PP] x8

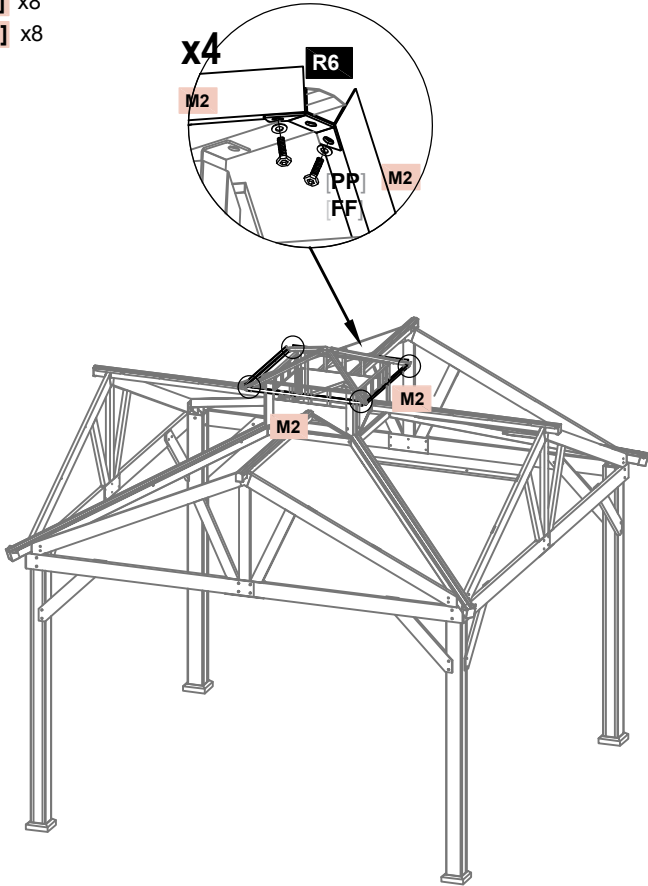

**STEP 23** Use two (2) [EE] bolts, two (2) [PP] flat washers and two (2) [TT] sealant washers to attach roof plate [T1] and [T2] to roof rib [H2].

Use two (2) [EE] bolts, two (2) [PP] flat washers and two (2) [TT] sealant washers to attach roof plate [T1] and [T2] to roof top support [M2]. Repeat with the other three (3) roof plates [T1] and [T2].

[EE] x16  
[PP] x16  
[TT] x16

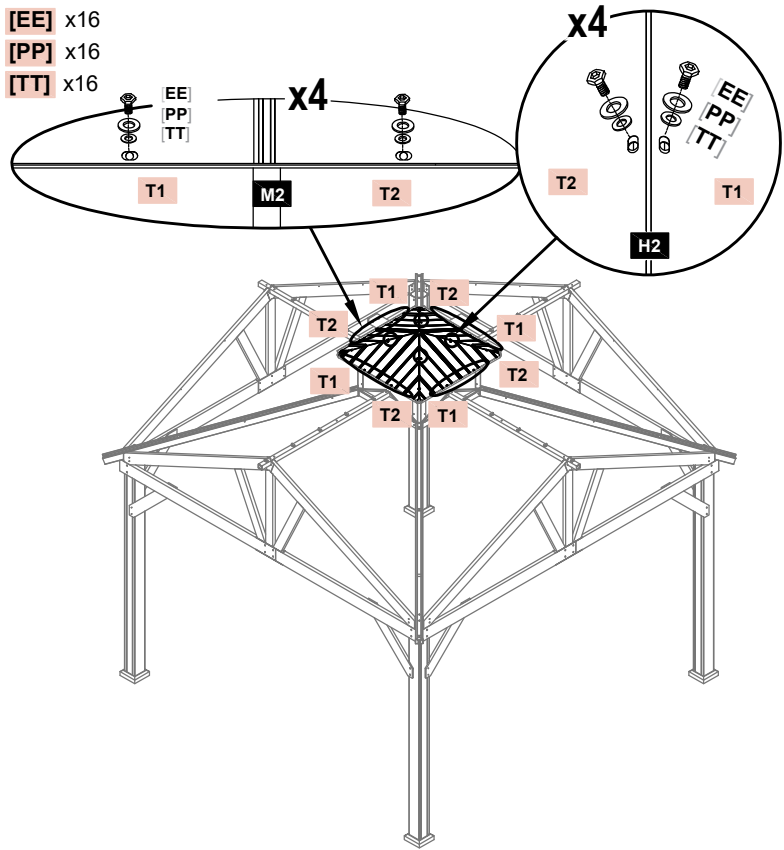

**STEP 24** Use one (1) [GG] bolts, one (1) [PP] flat washers and one (1) [TT] sealant washers to attach roof rib cover 3 [S3] to roof rib [H2]. Repeat with the other three (3) roof rib cover [S3].

[GG] x4  
[PP] x4  
[TT] x4

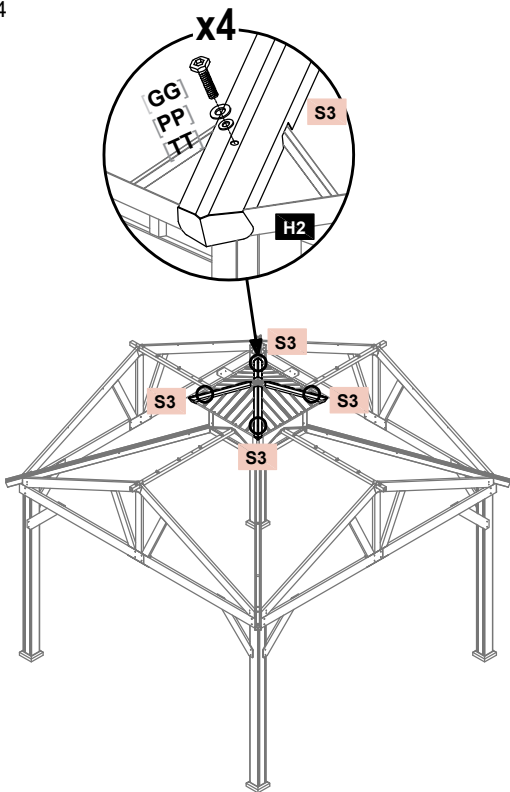

**STEP 25** Attach roof rib cover 4 [S4] to the top, and attach hook [U] to roof rib cover [S4].

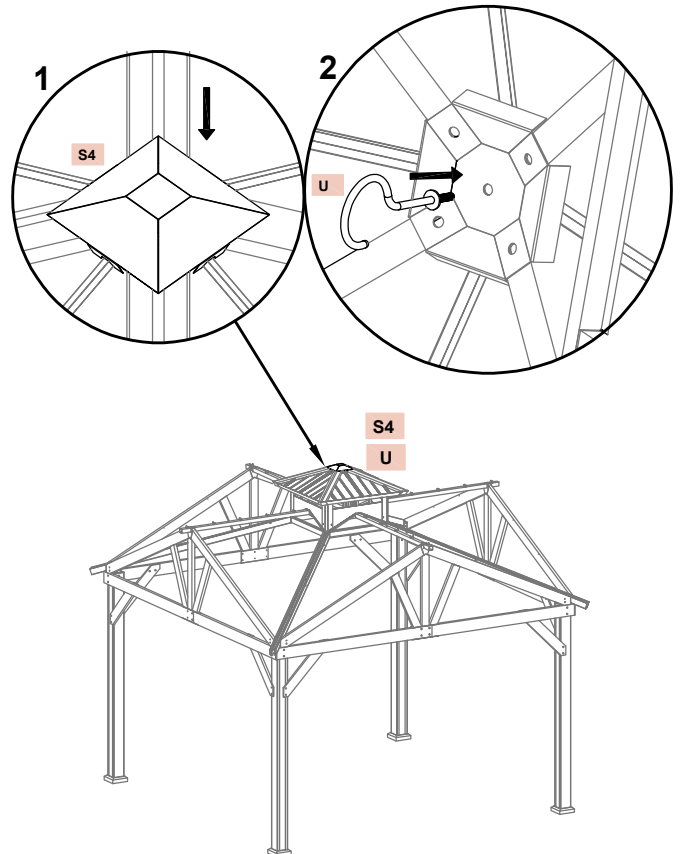

**STEP 26** Use one (1) [EE] bolt and one (1) [PP] flat washer to attach one (1) roof support 1 [L1] to roof rib [H1]. Use one (1) [AA] bolt to attach roof support [L1] to herringbone beam assembly [E1 E2].

Use one (1) [EE] bolt and one (1) [PP] flat washer to attach one (1) roof support 2 [L2] to roof rib [H1]. Use one (1) [AA] bolt to attach roof support [L2] to herringbone beam assembly [E1 E2].

Use one (1) [EE] bolt and one (1) [PP] flat washer to attach one (1) roof support 3 [L3] to roof rib [H1]. Use one (1) [AA] bolt to attach roof support [L3] to herringbone beam assembly [E1 E2].

Use one (1) [EE] bolt and one (1) [PP] flat washer to attach one (1) roof support 4 [L4] to roof rib [H1]. Use one (1) [AA] bolt to attach roof support [L4] to herringbone beam assembly [E1 E2].

Repeat with the other three (3) roof support [L1], [L2], [L3] and [L4].

[AA] x16

[EE] x16

[PP] x16

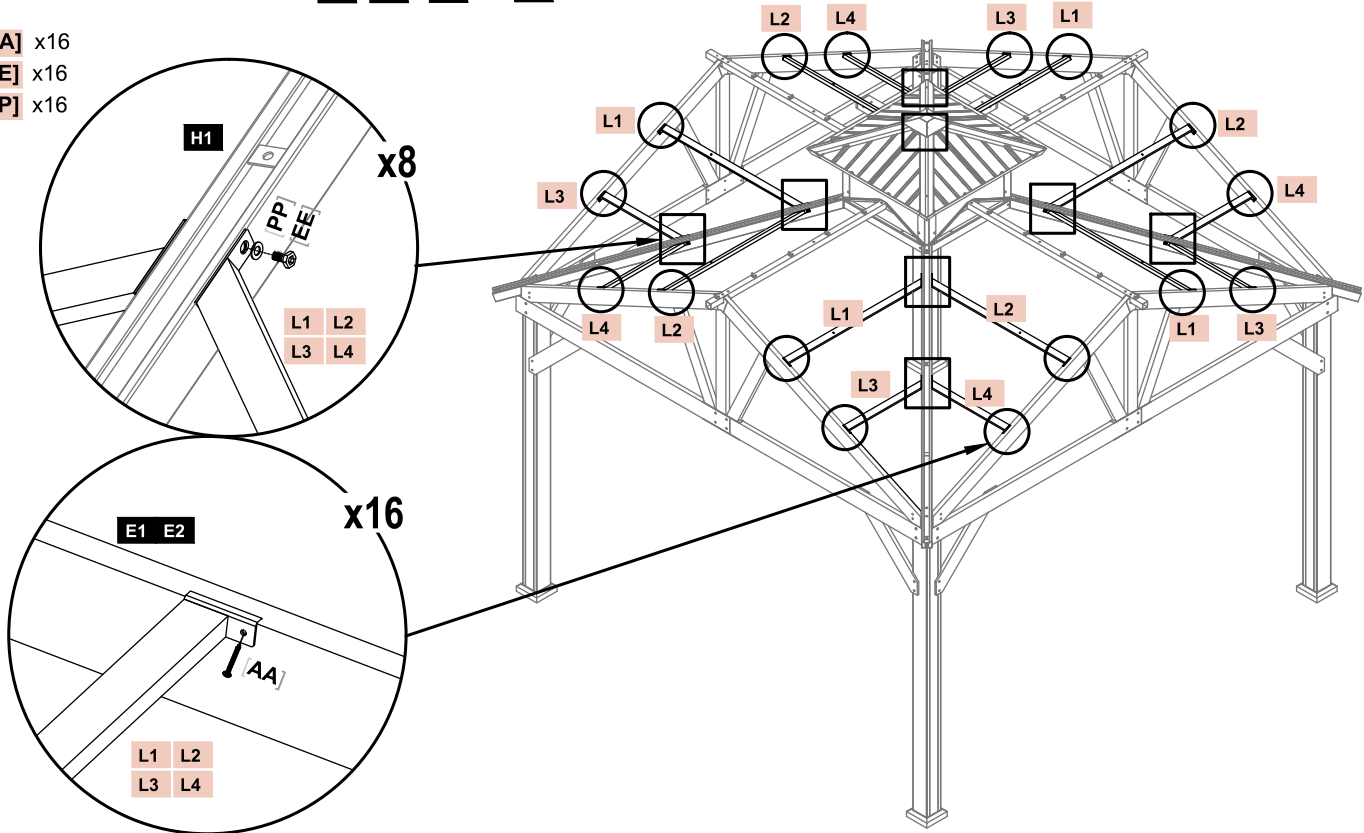

**STEP 27** Hook roof panels [T3], [T4], [T5], [T6], [T7] and [T8] to middle cross beam [K].

Use one (1) [DD] bolt, one (1) [OO] flat washer and one (1) [SS] sealant washers to attach roof panel [T5] to roof support [L2].

Use one (1) [DD] bolt, one (1) [OO] flat washer and one (1) [SS] sealant washers to attach roof panel [T6] to roof support [L1].

Repeat with the other four (4) roof panel T5 and T6.

[DD] x8

[OO] x8

[SS] x8

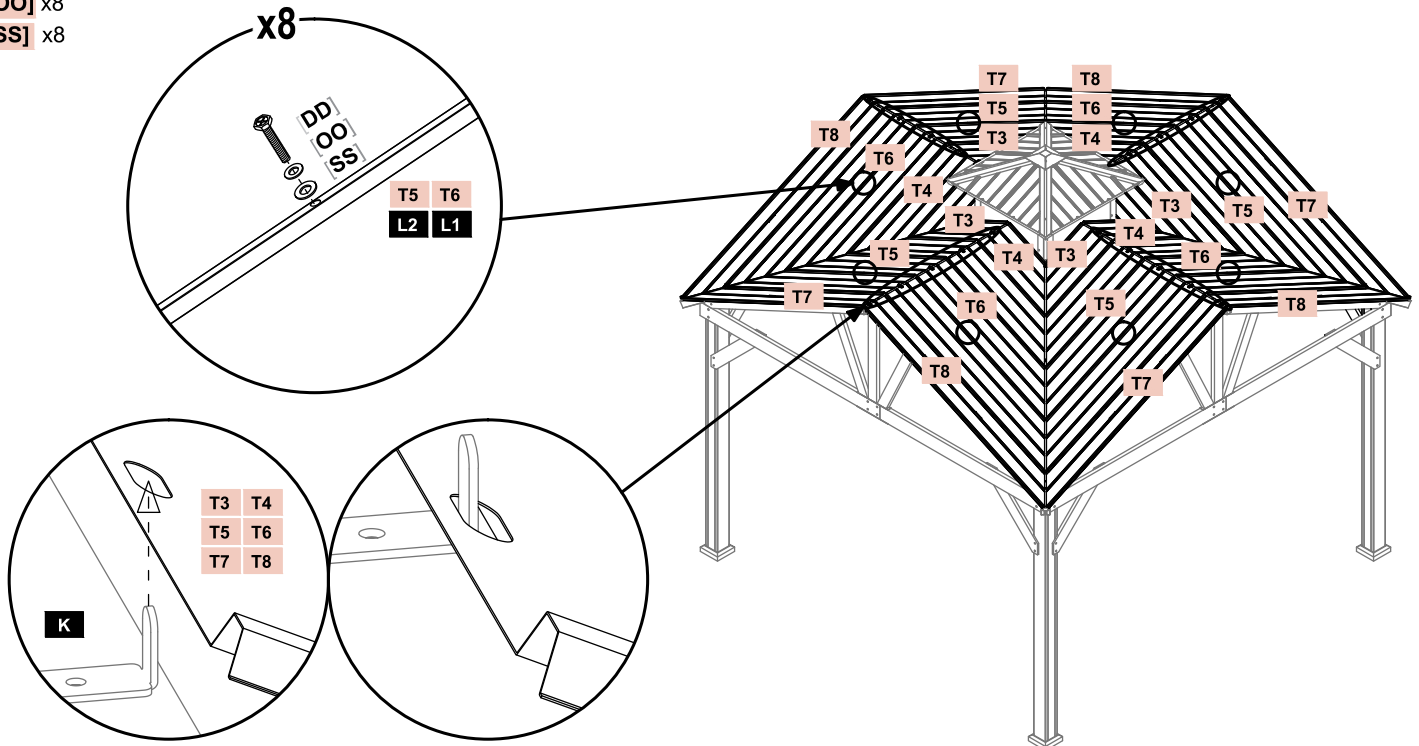

**STEP 28** Use two (2) **[GG]** bolts, two (2) **[PP]** flat washers and two (2) **[TT]** sealant washers to attach one (1) roof rib cover 2 **[S2]** to middle cross beam **[K]**. Repeat with the other three (3) roof rib cover **[S2]**.

- [GG]** x8
- [PP]** x8
- [TT]** x8

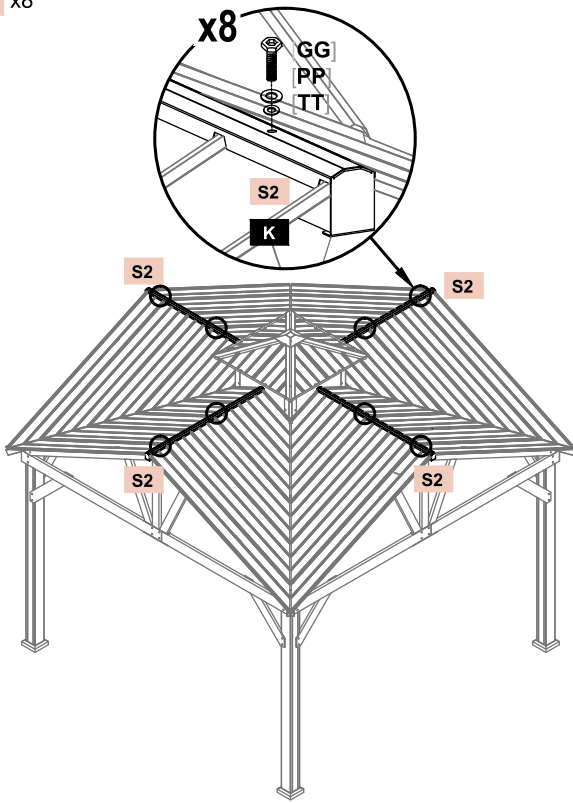

**STEP 29** Use one (1) **[GG]** bolt and one (1) **[PP]** flat washer to attach one (1) roof rib cover 1 **[S1]** to roof rib **[H1]**. Repeat with the other three (3) roof rib cover **[S1]**.

- [GG]** x4
- [PP]** x4

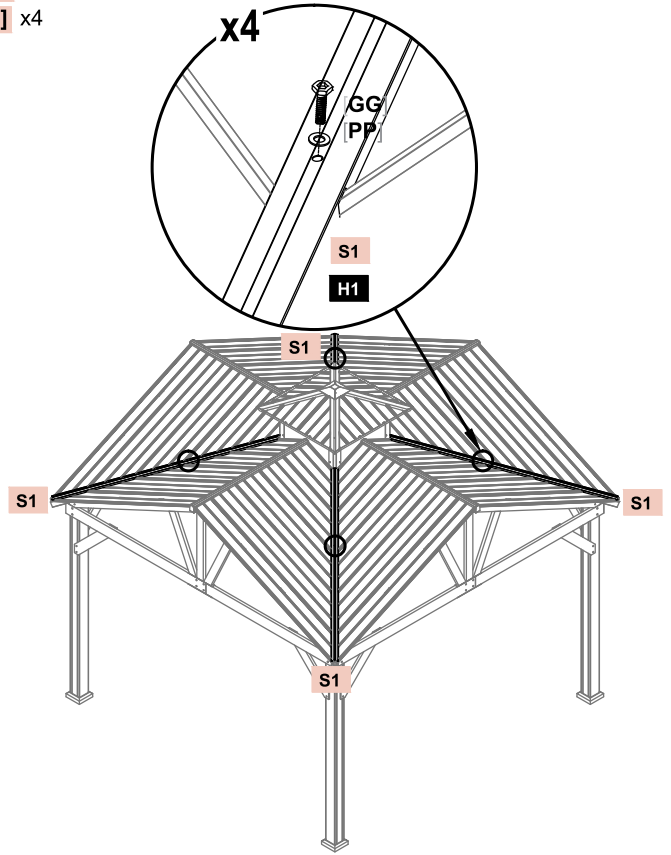

**STEP 30** Use one (1) **[GG]** bolt and one (1) **[PP]** flat washer to attach one (1) roof rib connector **[P]** to roof rib **[H1]**. Repeat with the other three (3) roof rib connector **[P]**.

- [GG]** x4
- [PP]** x4

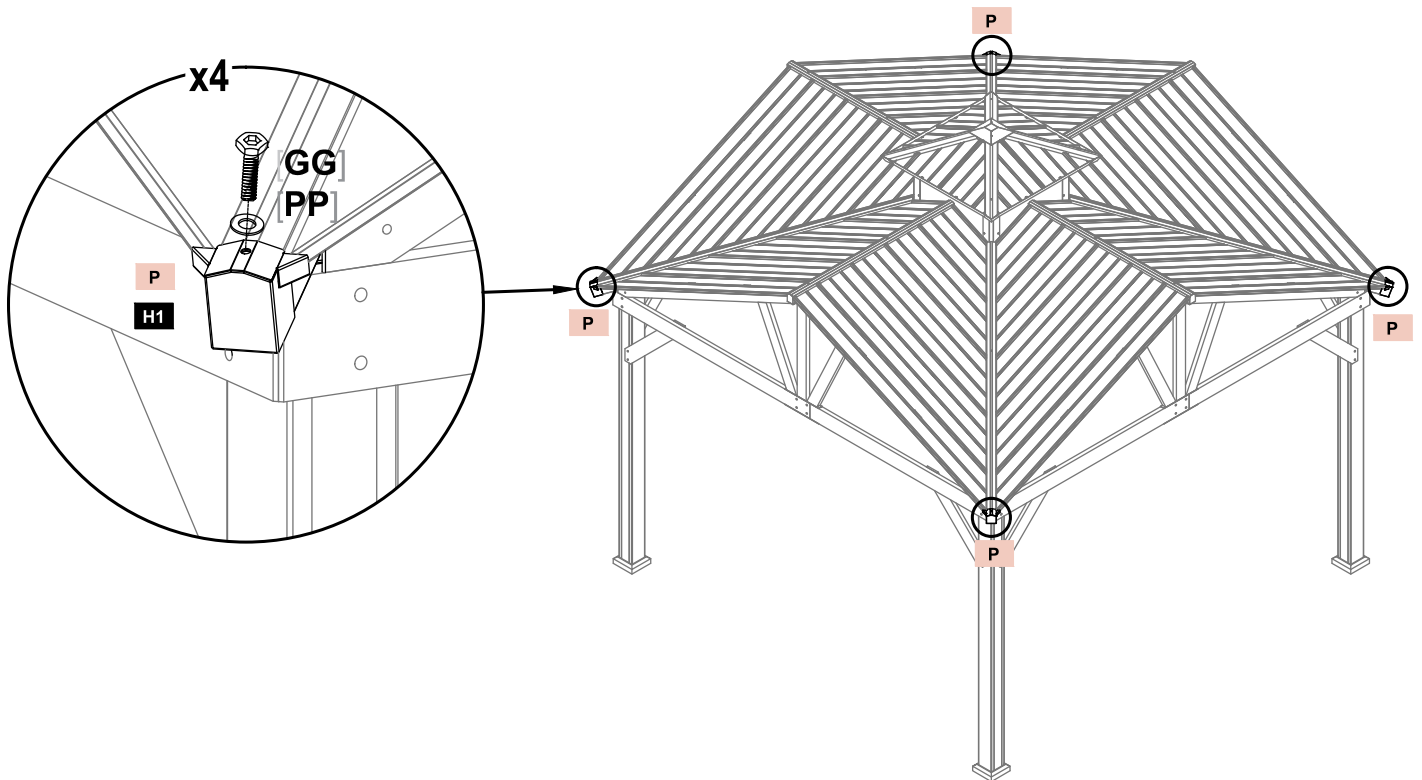

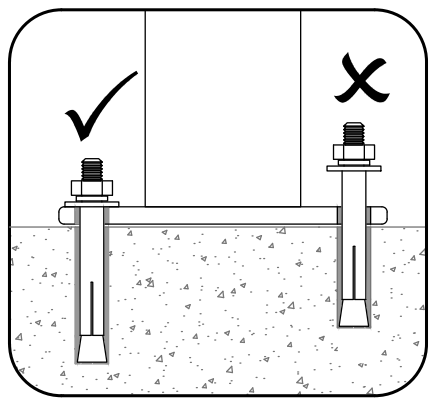
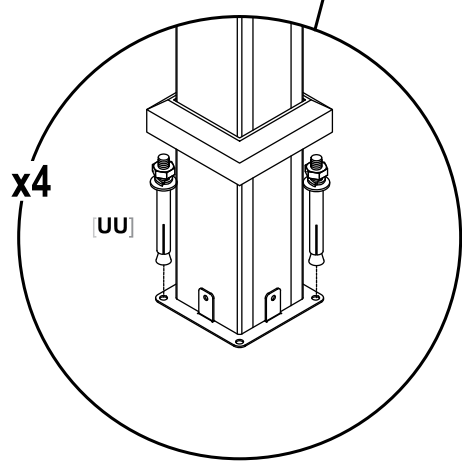
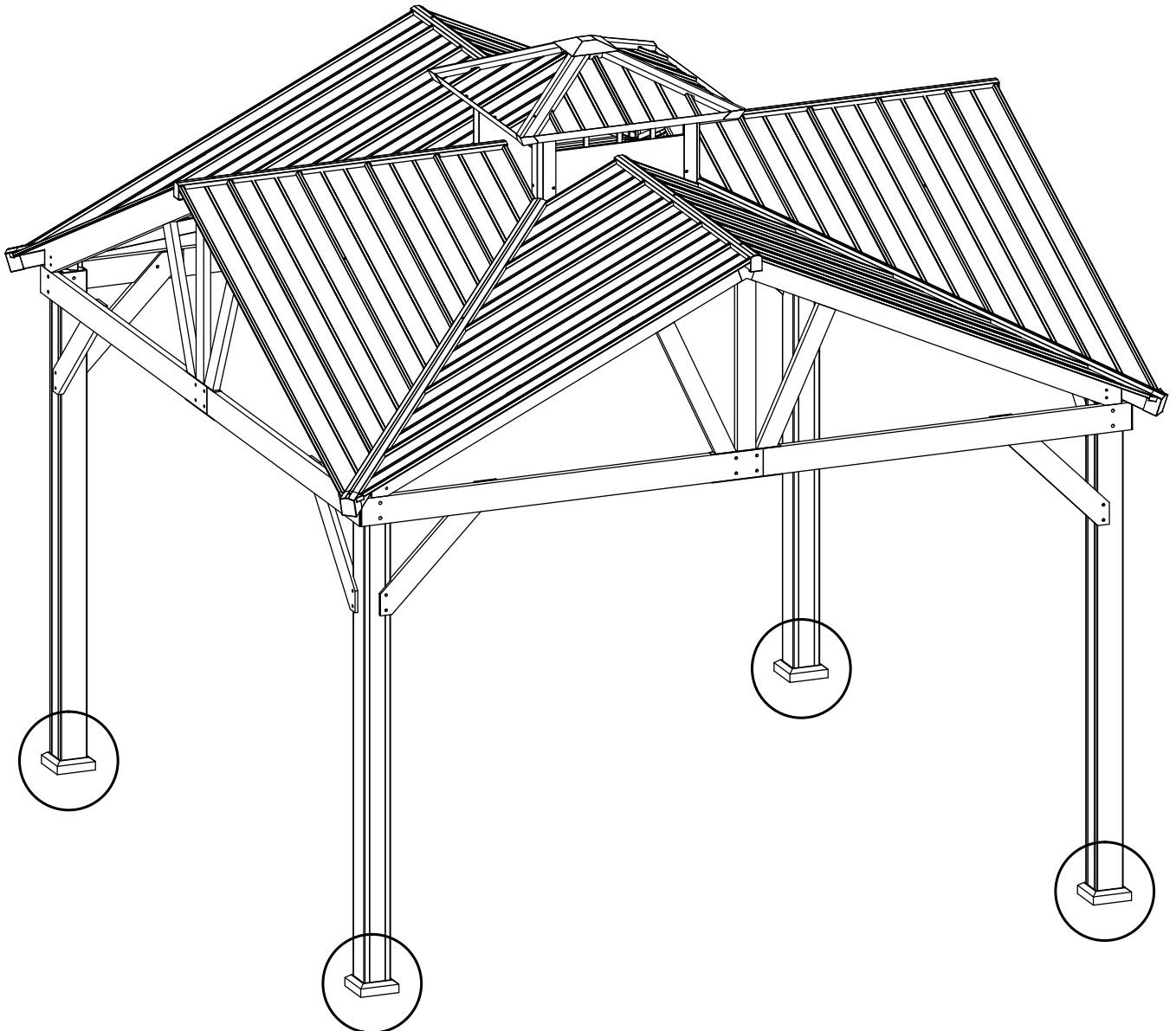

**STEP 31** Use two (2) [UU] expansion bolts to anchor each post foot base **B**. We recommend using a 3/8 inch drill bit when installing the included expansion bolts.

[UU] x8

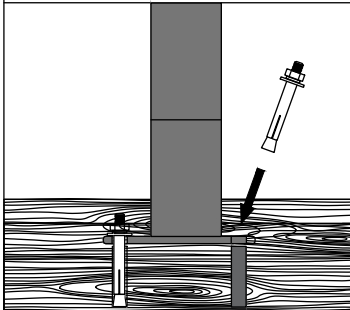
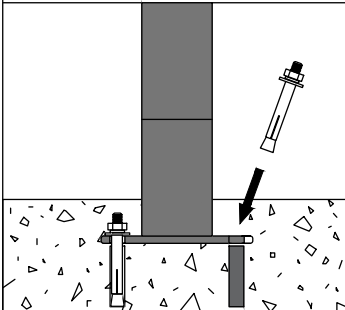

Outdoor Structure anchoring guide for anchoring gazebo to wood or concrete: If step 31, on page 14 in the assembly instructions is not properly completed, this will void the warranty.

**WARNING!** If your gazebo is not properly anchored, damage could occur. It is highly recommended for maximum safety that you mount and secure to wood or concrete footers. This is far better and safer than using ground stakes. The following are some examples of how to mount the structure to wood or concrete surfaces. Refer to local building codes or consider consulting a licensed contractor for assistance in the anchoring of this product.

WOOD	CONCRETE
	
<p>Anchors should be drilled into joists or reinforced blocking (not only deck boards).</p>  <p>Recommended Hardware: Expansion Bolt</p>	<p>Pre-drill holes for appropriately sized concrete anchors</p>  <p>Recommended Hardware: Expansion Bolt</p>

If digging for foundation, please double check for possibility of any underground utilities such as gas, telephone, cable or sprinkler lines. Refer to your local building and city codes, ordinances, neighborhood covenants, or height restrictions regarding this type of structure for guidance on acceptable installation requirements.

**CAUTION**

DO NOT climb or walk on roof for any reason.

- Our components are intended for privacy, decorative and ornamental use only.
- Product is NOT INTENDED for the following:
  - A safety barrier to prevent unsupervised access to pools, hot tubs, spas or ponds.
  - As load bearing support for a building, structure, heavy objects or swings.
  - Used in structures that trap wind, rain or snow that would create extra load on the product.
  - Accumulated snow must be removed from roof.
  - DO NOT climb or walk on roof for any reason.

**LIMITED WARRANTY**

We warrants this product against defects in materials and workmanship for a period of one (1) year from the original date of purchase. To the extent any such defects occur, our products will send the appropriate replacement part (s) at no charge.

This warranty does not cover:

- Inspection costs or labor for replacement of any defective parts);
- Incidental or consequential damages;
- Cosmetic defects which DO NOT affect performance;
- Normal wear and tear;
- Damage due to vandalism; acts of nature, including but not limited to wind, storms, hail, floods;
- Improper assembly, installation, or use;
- Discoloration or fading of the finish as a result of exposure to chemicals, spills, pool or salt water
- Corrosion/rust.

Your product has been designed for safety and quality. Any modifications made to the original product could compromise its structural integrity or function, and could lead to product failure or personal injury. As such, modifying this product voids any and all warranties.

This product is warranted for RESIDENTIAL USE ONLY, and is not for commercial, contract or other non-residential purposes. Products disclaims all other representations and warranties of any kind, express or implied.

The warranty applies to the original purchaser and is non-transferable. It does not apply to purchases of display models, or when the product is sold on clearance or "as is". We makes no warranty whatsoever in respect to accessories or parts not supplied with it. This warranty shall apply only within the boundaries of the United States of America and Canada. This warranty gives the original purchaser specific rights, and the original purchaser may also have other rights, which vary from state to state.

