

INSTRUCTION MANUAL



3PCS Cast Aluminum Bistro Set

INTRODUCTION





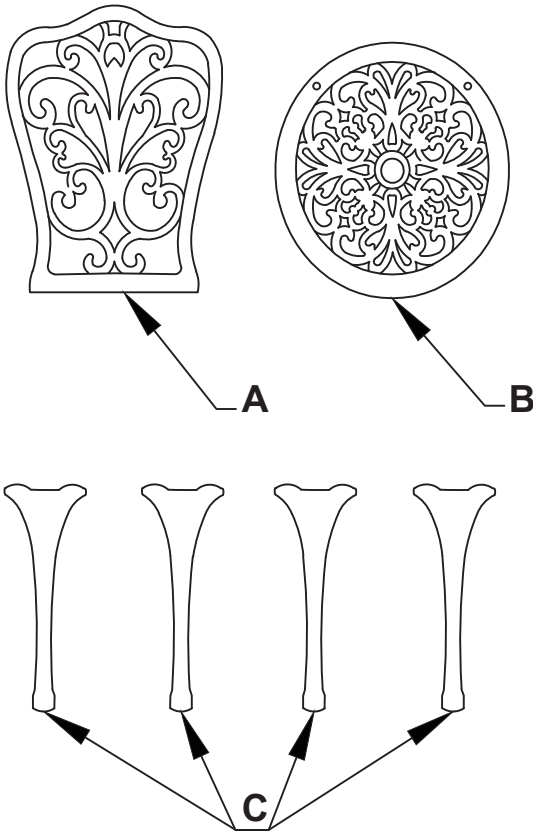
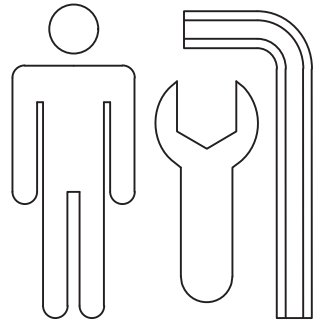

Thanks for purchasing and trusting us with your home decorating plans. This product is a piece of furniture designed and made by us.

We are committed to R&D and innovation, creating the most exquisite and diverse outdoor series.

After unpacking and before each use, check whether the item shows any damage. In addition, check that you have all parts and hardware before assembly. If there is any damage, please do not use it and call customer service or email. If you do not have all the parts lists, have your dealer contact us, and we will send them to you immediately.

This piece of furniture is intended for indoor and outdoor use. Please take the time to read and follow the instructions below. Then, use this item as described in this operating manual. We accept no liability for damage caused by improper use



Part Number	Images and Sizes	Qty.
A		1
B		1
C		4
D	 M8	10
E	 M8	10
F	 M8	10
G	 M8*30	10

ASSEMBLY INSTRUCTIONS



CAVEAT

Note: Please only tighten any bolts once all bolts are placed correctly and the product is lying flat. If you tighten one bolt, it may cause other bolts to get out of position.

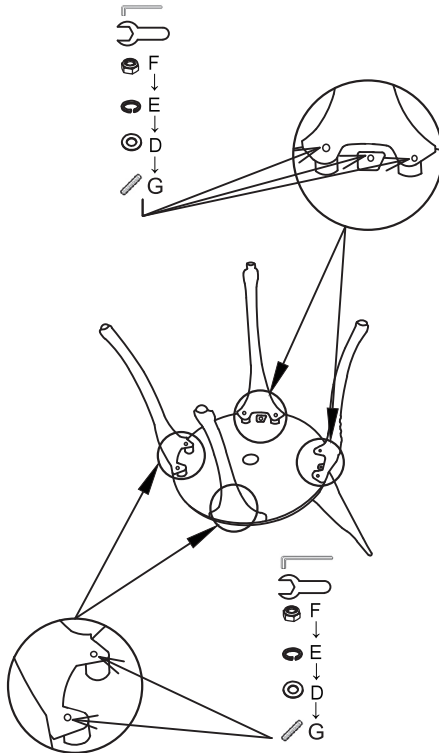

STEP 1

Attach the backrest (A) to the seat frame (B) using 2 bolts (G), 2 washers (D), 2 spring washers (E) and 2 nuts (F). Do not over-tighten the screws.

Next, attach the assembled frame to four legs (C) using 8 bolts (G), 8 washers (D), 8 spring washers (E) and 8 nuts (F). Again, do not over-tighten the screws.

Note: When you use bolt (G) with the hollow end facing up.

Upon completing the entire assembly and bolting up, you can tighten down all screws.

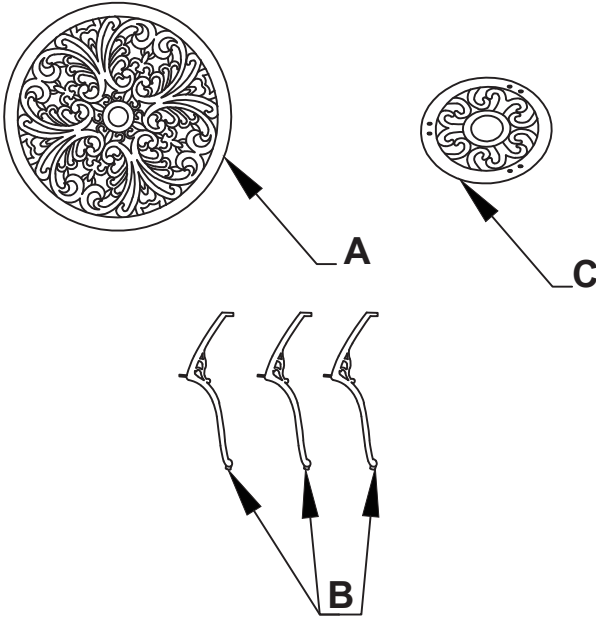
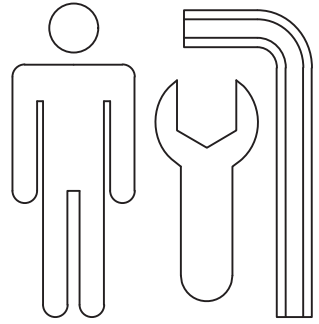

Part Number	Images and Sizes	Qty.
A		1
B		3
C		1
D		3
E		3

I	 M6	6	F	 M8	3
J	 M6	6	G	 M8*30	3
K	 M6	6	H	 M6*35	6

ASSEMBLY INSTRUCTIONS



CAVEAT

Note: Please only tighten any bolts once all bolts are placed correctly and the product is lying flat. If you tighten one bolt, it may cause other bolts to get out of position.

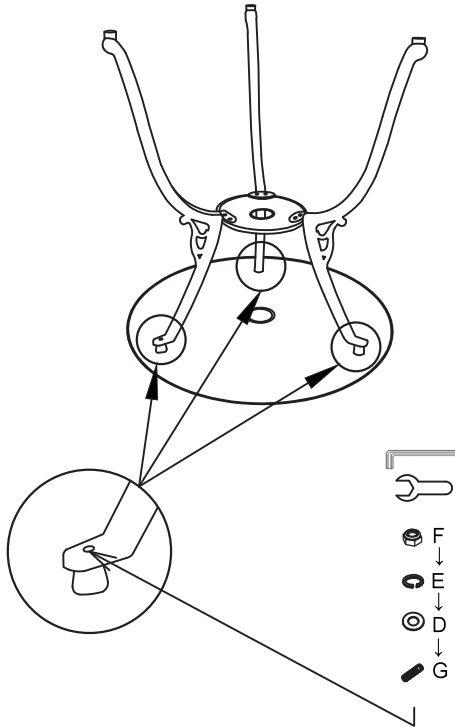

STEP 1

Attach the tabletop (A) to three legs (B) using 3 bolts (G), 3 washers (D), 3 spring washers (E), and 3 nuts (F). Do not over-tighten the screws.

Note: When you use bolt (G) with the hollow end facing up.

ASSEMBLY INSTRUCTIONS

CAVEAT

Note: Please only tighten any bolts once all bolts are placed correctly and the product is lying flat. If you tighten one bolt, it may cause other bolts to get out of position.

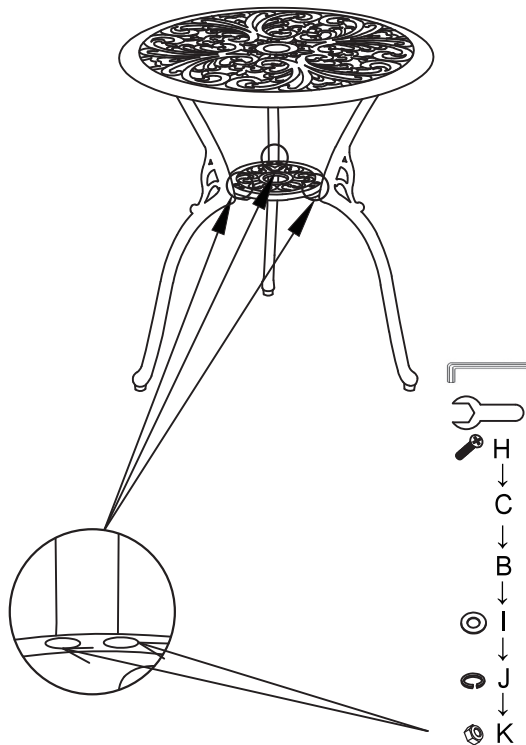

STEP 2

Attach the leg support (C) to three legs (B) using 6 bolts (H), 6 washers (I), 6 spring washers (J), and 6 nuts (K). Do not over-tighten the screws.

Upon completing the entire assembly and bolting up, you can tighten down all screws.

CARE AND MAINTENANCE

Follow the instructions for the product's material to ensure it stays in the best shape as long as possible. The information below is a general guideline.

Don't hesitate to get in touch with us to learn more.

- Only rinse it thoroughly with clean water to wash away dirt and grime. Never use abrasive cleansers on the furniture since they can attack the surface and leave behind scratch marks.
- For stubborn grime and stains, use a soft sponge and mild soapy water. Then dry it with a cloth or paper towel.
- Check the stability of the screws, nuts, and nut caps before each use. Then, tighten them up after one to two months' use whenever required.
- Avoid improper use, and be careful not to scratch or damage the surface with sharp objects.
- When you move your furniture, lift it rather than pulling or pushing it to avoid damaging the floor, legs, and mounting.