

edishinē

Pendant Light

[Instruction Manual]

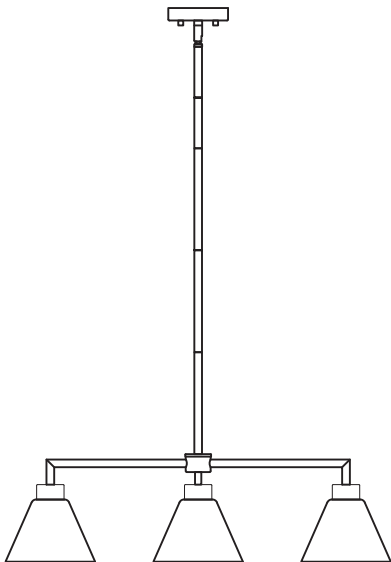

Please pay attention to the warning signs
Read the instructions with caution before operating
and keep it properly

Warning:

Risk of fire. Min 167°F/75°C supply conductors. Consult a qualified electrician to ensure correct installation. Before installation, please turn off the main power of the circuit breaker to prevent possible electric shock.

Installation Instructions

FIG.1. Turn the wall switch to the "OFF" position.

Depending on which type of fuse box in your home:

FIG.2. Either turn the main (Master) switch to the "OFF" position to cut off the power supply of the entire home, or turn off the individual switch that supplies power to where the fixture will be installed.

OR

FIG.3. Either turn the main (Master) switch to the "OFF" position to cut off the power supply of the entire home, or unscrew the fuse that supplies power to where the fuse will be installed.

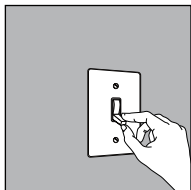

FIG.1 WALL SWITCH

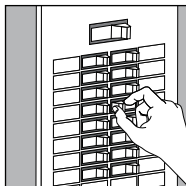

FIG.2 BREAKER PANEL

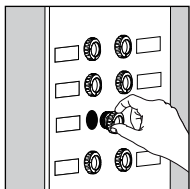
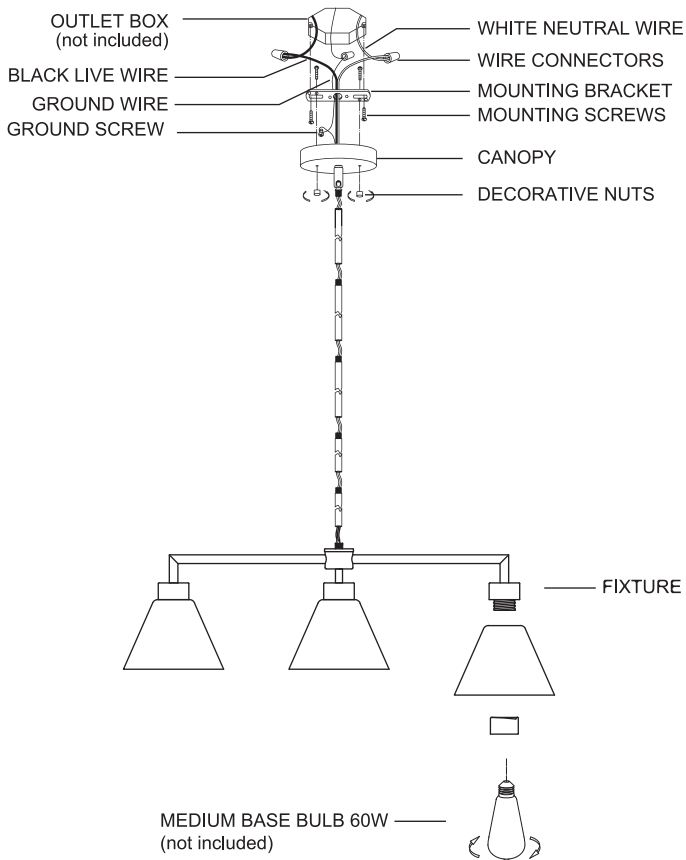

FIG.3 FUSE BOX



1. Choose the pipe or pipes you needed, pass the wire through the pipes and canopy, then connect the canopy, pipe, glass shade and bulb(not included).

NOTE:You can choose the number of pipes to assemble according to the length you need.

NOTE:If the screw in the pipe makes threading difficult, you can separate it from the pipe by rotation, then thread the wire through the pipe and screw separately, and assemble them together again.

2. Install mounting bracket onto outlet box with provided outlet box screws.
3. Connect COPPER WIRE (ground wire) from the light to the ground wire from outlet box by using Green Grounding Screw onto the bracket. Connect BLACK WIRE (live wire) from light to the bare end of live wire from outlet box by twisting wire connector. Connect the WHITE WIRE (neutral wire) from the light to the bare end of neutral wire from outlet box with the other wire connector.
4. Make sure the wire connections are secure. Carefully place wires into outlet box.
5. Install the light fixture over mounting bracket and secure the fixture with decorative nut.

Parts List

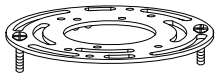

Mounting Bracket
X 1



Mounting Screw
X 2

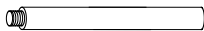

12" Pipe
X 3



Wire Connector
X 3



6" Pipe
X 2



Decorative Nut
X 2

Specifications

- Input Voltage: 120VAC 60Hz
- Max.Load Power: Incandescent Bulb 60W
- Socket Type: Standard Medium E26

One Year Limited Warranty

Supported by our professional R&D team and QC team, we provide One Year Warranty for materials and workmanship from the purchase date. Please note that the warranty does not cover damage caused by personal misuse or improper installation.

Please attach your Order ID and Name so that our dedicated customer service team can help you better.



Made in China