

IMPORTANT INSTRUCTIONS AND OPERATING MANUAL

ELECTRIC HEATER



NO VENTING REQUIRED



WARNING

Read and understand this entire owner's manual, including all safety information before plugging in or using this appliance. Failure to do so could result in fire, electric shock, or serious personal injury.

CERTIFIED UNDER CANADIAN AND AMERICAN NATIONAL STANDARDS: ETL



TABLE OF CONTENTS

IMPORTANT SAFETY INSTRUCTIONS.....	2
1.0 PACKING LIST.....	4
1.1 DIMENSIONS.....	5
2.0 ELECTRICAL INSTALLATION NOTES.....	7
2.1 GENERAL INSTRUCTIONS.....	7
3.0 INSTALLATION INSTRUCTIONS.....	8
3.1 UNPACKING AND TESTING APPLIANCE WALL.....	8
3.2 GROUNDING APPLIANCE.....	8
3.3 ASSEMBLY.....	8
4.0 OPERATING INSTRUCTIONS.....	9
4.1 MAIN POWER BUTTON.....	9
4.2 CONTROL PANEL / REMOTE CONTROL OPERATION.....	9
4.3 REMOVE CONTROL.....	12
5.0 TROUBLE SHOOTING GUIDE.....	12
6.0 MAINTENANCE.....	14
6.1 PARTIALLY REFLECTIVE GLASS CLEANING.....	14
6.2 SCHEMATIC DIAGRAM.....	15
7.0 LIMITED WARRANTY.....	15

IMPORTANT SAFETY INSTRUCTION



WARNING

These instructions should be carefully read before installation and retained by the user. The booklet must be kept and delivered to the new user in case of disposal of the heater. The Manufacturer reserves the right to vary the features of the product without prior notice. The technical data are indicative only.

- 1. THIS APPLIANCE IS HOT WHEN OPERATED AND CAN CAUSE SEVERE BURNS IF TOUCHED.**
- Do not operate appliances before reading and understanding operating instructions. Failure to operate appliances according to operating instructions could cause fire or injury.
- Keep combustible materials, such as furniture, pillows, bedding, papers, clothes and curtains at least 3 feet (0.9 m) from the front of this appliance and keep away from the sides and the rear. **WARNING:** To avoid overheating, do not cover the heater. The clearance may be inadequate when installed in a Recreational Vehicle with the slide-out closed.
- Risk of burns. Power to the appliance should be turned off and the appliance allowed to cool before servicing. To disconnect power to the appliance, turn controls to off, then remove the plug from the outlet.
- Do not install damaged, incomplete or substitute components.
- Young children should be carefully supervised when they are in the same room as the appliance. Toddlers, young children and others may be susceptible to accidental contact burns.
- To prevent accidental swallowing, media bed kits should be kept away from children and infants.
- Remote control contains small batteries. Keep away from children. If swallowed, seek medical attention immediately.
- Do not install battery backward, charge, put in fire or mix with used or other battery types-may explode leak causing injury.
- Ensure you have incorporated adequate safety measures to protect infants/toddlers from touching hot surfaces.
- It is imperative that the control compartments, circulating blower and its passageway in the appliance and are kept clean. The appliance should be inspected before use and at least annually by a qualified service person.
- Under no circumstances should this appliance be modified.
- Do not use this appliance if any part has been in contact with water. Immediately call a qualified service technician to inspect the appliance and to replace any part of the control system which has been in contact with water.
- Do not operate the appliance with the glass door removed, cracked or broken. Replacement of the glass should be done by a licensed or qualified service person.
- Do not strike or slam shut the appliance glass door.
- Keep the packaging material out of reach of children and dispose of the material in a safe manner. As with all plastic bags, these are not toys and should be kept away from children and infants.
- Servicing should be done only while the appliance is disconnected from the power supply circuit.

18. Always unplug the appliance when not in use.
19. Do not operate this appliance with a damaged cord or plug after the appliance malfunctions, or has been dropped or damaged in any manner. Return appliance to authorized service facility for examination, electrical or mechanical adjustment, or repair.
20. Do not use appliance outdoors.
21. Never place the appliance where it may fall into a bathtub or other water container.
22. Do not run the cord under carpeting. Do not cover the cord with throw rugs, runners, etc. Arrange the cord away from the cluttered area and where it will not be tripped over.
23. Connect to properly grounded outlets only.
24. Do not insert or allow foreign objects to enter any ventilation or exhaust opening as this may cause an electric shock or fire, or damage the appliance.
25. To prevent a possible fire, do not block air intakes or exhaust in any manner. Do not use on soft surfaces, like a carpet, where openings may become blocked.
26. Always plug appliances directly into a wall outlet/receptacle. Never use an extension cord or relocatable power tap (outlet/power strip).

SAVE THESE INSTRUCTIONS

1.0 PACKING LIST

No	Description	Quantity
1	Electric Heater	1 pc
2	Installation and Operating Instructions	1 pc
3	Remote Control (Battery included)	1 pc

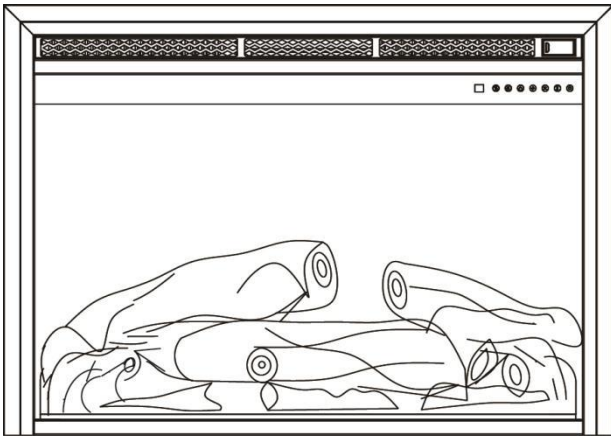

Style A

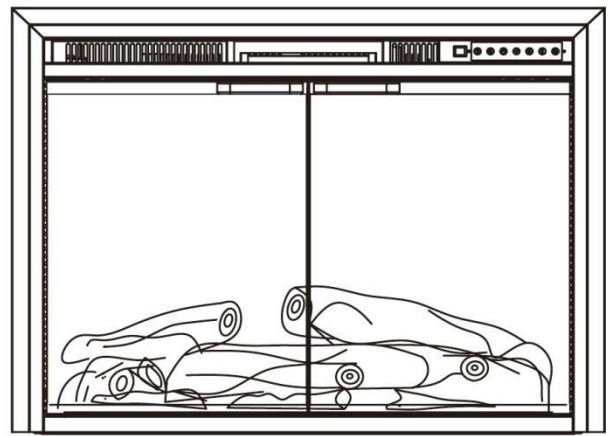

Style B

①

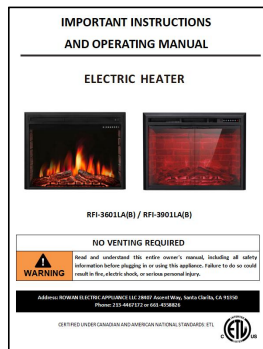

②



③

1.1 DIMENSIONS

FRONT

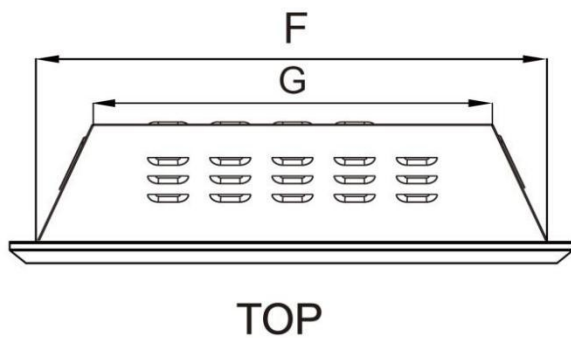
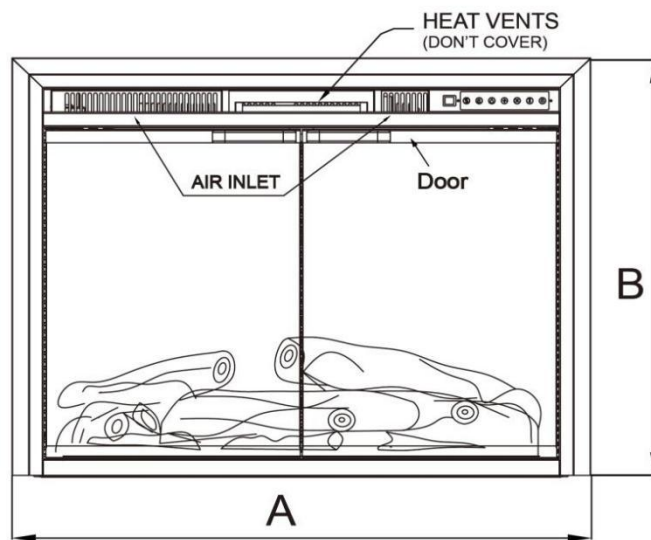
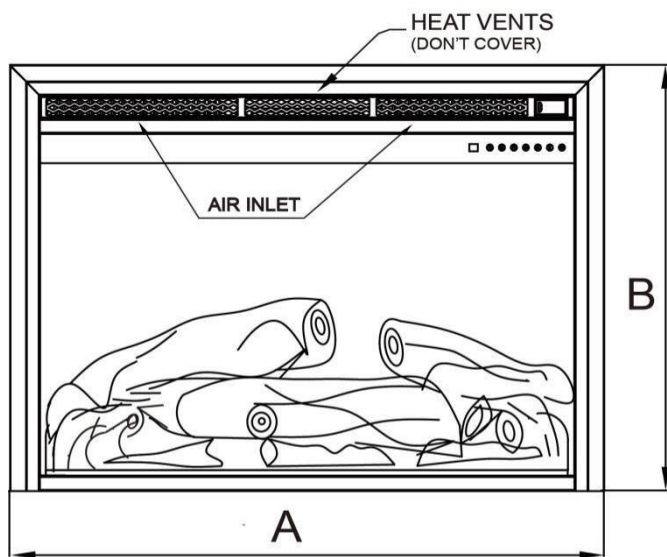

TOP

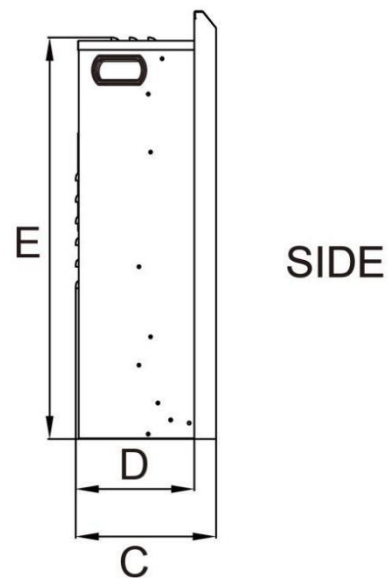

SIDE

Model#	A	B	C	D	E	F	G	A	B	C	D	E	F	G
	mm	mm	m m	mm	mm	mm	mm	inch	inch	inch	inch	inch	inch	inch
RFI-3601LA	914	686	228	193	642.8	829	703.86	36	27.01	8.98	7.60	25.31	32.64	27.71
RFI-3901LA	990	686	228	193	642.8	905	779.86	39	27.01	8.98	7.60	25.31	35.63	30.70
RFI-3601LB	864	660.8	165	145	643	829	740	34	26.02	6.5	5.7	25.3	32.64	29.2
RFI-3901LB	940	660.8	165	145	643	905	816	37	26.02	6.5	5.7	25.3	35.63	32.2

FRONT

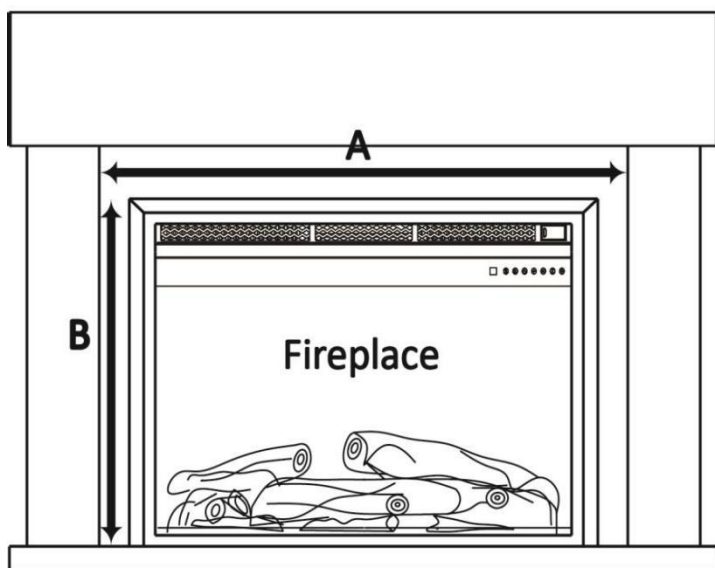

SIDE

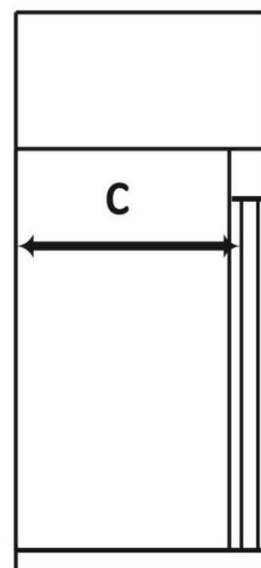

Reference size of the opening for Flush Mounted Installation:

Model#	A	B	C	A	B	C
	mm	mm	mm	inch	inch	inch
RFI-3601LA	840-905	655-675	200-250	33.07-35.63	25.79-26.57	7.87-9.84
RFI-3901LA	916-981	655-675	200-250	36.06-38.62	25.79-26.57	7.87-9.84
RFI-3601LB	836-854	646-654	175-200	32.91-33.62	25.43-25.74	6.9-7.9
RFI-3901LB	915-930	646-654	175-200	36-36.3	25.43-25.74	6.9-7.9

NOTE: Please leave enough space to pace the power cord on the right side of the fireplace.

LISTING APPROVALS

This appliance has been tested by the ETL Standards for fixed and location dedicated electric room appliances in the United States and Canada. If you need assistance during installation, please contact your local dealer.

NOTE: This appliance must be electrically wired and grounded by local or, in the absence of local, with National Electric Code ANSI/NFPA 70-latest edition in the United States or the Canadian Electric Code, ETL in Canada.

Model Number	RFI-3601LA(B) / RFI-3901LA(B)
Description	Recessed Appliance
Voltage	120VAC
Watts	Max 1500W
Amps	12.5AMP
BTUs	5100BTU

2.0 ELECTRICAL INSTALLATION NOTES

2.1 GENERAL INSTRUCTIONS



CAUTION - Some parts of this product can become very hot and cause burns. Particular attention has to be given where children and vulnerable people are present.

- A. Prior to plugging your appliance into an electrical outlet, verify that the house circuit breakers for the outlet are on.
- B. The appliance may emit a slight, harmless odor when first used. This odor is normal and it is caused by the initial heating of internal appliance elements and will not occur again.
- C. If your appliance does not emit heat, consult the operation section of this manual for further information.
- D. Use with a ETL or UL certified surge protector.



RISK OF FIRE! THE POWER CORD MUST NOT BE PINCHED AGAINST A SHARP EDGE. SECURE CORD TO AVOID TRIPPING OR SNAGGING TO REDUCE THE RISK OF FIRE, ELECTRIC SHOCK, OR PERSONAL INJURY. DO NOT RUN CORD UNDER CARPETING. DO NOT COVER THE CORD WITH THROW RUGS, RUNNERS, ETC.

ARRANGE CORD AWAY FROM CLUTTERED AREAS WHERE IT WILL NOT BE TRIPPED OVER.

RISK OF FIRE. TO PREVENT A POSSIBLE FIRE, DO NOT BLOCK AIR INTAKE OR EXHAUST IN ANY MANNER. DO NOT USE ON SOFT SURFACES WHERE OPENINGS MAY BECOME BLOCKED.

RISK OF FIRE. DO NOT BLOW OR PLACE INSULATION AGAINST THE APPLIANCE.

THIS ELECTRIC APPLIANCE IS TESTED AND LISTED FOR USE ONLY WITH THE APPROVED OPTIONAL ACCESSORIES. USE OF OPTIONAL ACCESSORIES NOT SPECIFICALLY TESTED FOR THIS ELECTRIC APPLIANCE COULD VOID THE WARRANTY AND/OR RESULT IN A SAFETY HAZARD.

IF THE INFORMATION IN THESE INSTRUCTIONS IS NOT FOLLOWED EXACTLY, A FIRE MAY RESULT CAUSING PROPERTY DAMAGE, PERSONAL INJURY OR DEATH. DO NOT STORE OR USE GASOLINE OR OTHER FLAMMABLE VAPORS IN THE VICINITY OF THIS OR ANY OTHER APPLIANCE.

THIS APPLIANCE IS HEAVY. IT IS HIGHLY RECOMMENDED THAT TWO PEOPLE INSTALL THIS APPLIANCE.

HEATER VENTS ON THE ELECTRIC APPLIANCE CAN NOT, IN ANY WAY, BE COVERED. AS IT MAY CREATE A FIRE HAZARD.

Follow all national and local electrical codes.

1. The heater must not be recessed in the ceiling. There must be enough space around the top of the heater to ensure adequate ventilation.
2. The heater should be at least 60 cm away from any surrounding walls.
3. A distance of at least 90 cm should always be left in front of the heaters to ensure safety.
4. The Heater should be mounted at a minimum of 20 cm above ground level.
5. The Heater must not be located either directly below, or in front of a socket outlet.
6. The heater must be installed so as to prevent any control switches from being able to be touched by anyone who is in the shower or bath.
7. Make sure that there is no possibility of inflammable material, combustible material, or curtains coming into contact with the heater, there is a risk of fire if this happens.
- 8. DO NOT LEAVE THE HEATER UNATTENDED DURING USE.**

3.0 INSTALLATION INSTRUCTIONS

3.1 UNPACKING AND TESTING APPLIANCE WALL

Carefully remove the appliance from the box. Prior to installing the appliance, test to make sure the appliance operates properly by plugging the power supply cord into a conveniently located 120 Volt grounded outlet.

3.2 GROUNDING APPLIANCE

This appliance is for use on 120 Volts. The cord has a plug as shown in (A). An adapter as shown in (C) is available for connecting three-blade grounding-type plugs to two-slot receptacles. The green grounding lug extending from the adapter must be connected to a permanent ground such as a properly grounded outlet box. The adapter should not be used if a three-slot grounded receptacle is available.

To disconnect the appliance, turn the controls off, then remove the plug from the outlet.

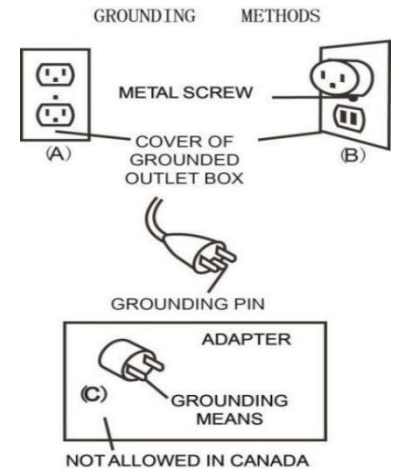

3.3 ASSEMBLY



ALWAYS unplug this fireplace heater **before assembly or cleaning, or before relocating.** Failure to do so could result in **electric shock, fire, or personal injury.**

KEEP drapery and other furnishings at least **3ft /0.9m** from the **front and sides** of the electric fireplace.

AFTER installation, ensure that there is $\geq 0.004 \text{ m}^2$ **ventilation area** between the **inside and outside** of the fireplace mantel.

Your new electric fireplace may be installed virtually anywhere in your home. However, when choosing allocation ensure that the general instructions are followed. For the best results, install out of direct sunlight. Power supply service must be either completed or placed within the electric fireplace prior to finishing to avoid reconstruction.

When moving the insert into the mantel, do not let the bottom of the insert touch the mantel to avoid a scratch.

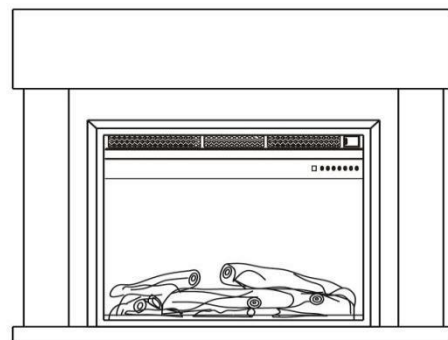
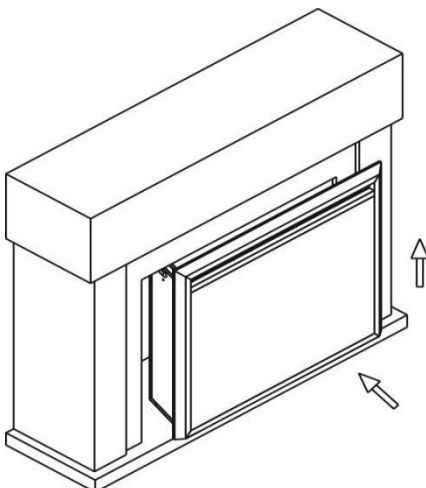

4.0 OPERATING INSTRUCTIONS

Once the appliance has been plugged into a grounded electrical outlet, it is ready to operate.

4.1 MAIN POWER BUTTON

The Main Power Button is located on the upper right (left) of the fireplace as illustrated. Press the indicator to turn on the appliance, press the other side turns it off.

(Only for RFI-3601LA / RFI-3901LA)

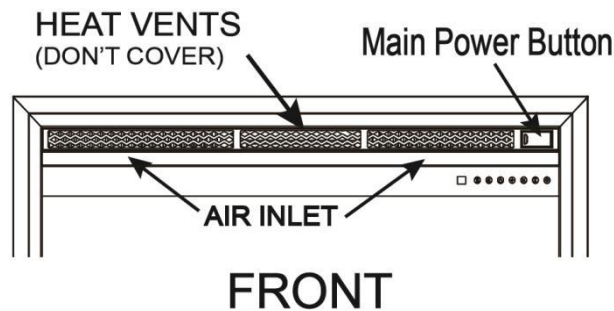

Note: Make sure the Main Power Switch is turned on before operating.

4.2 CONTROL PANEL / REMOTE CONTROL OPERATION

(Main Power Switch must be turned ON before using the remote control.)

The touch display panel is shown on the upper right of the appliance.

◆ Move the battery's transparent insulating piece away before using remote control.



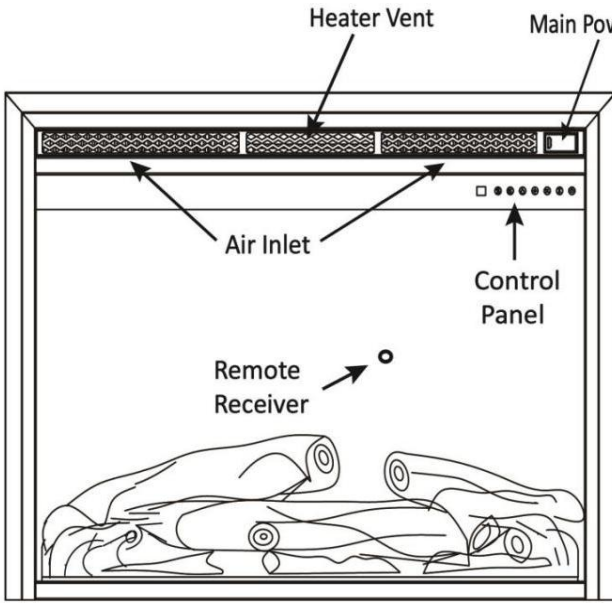



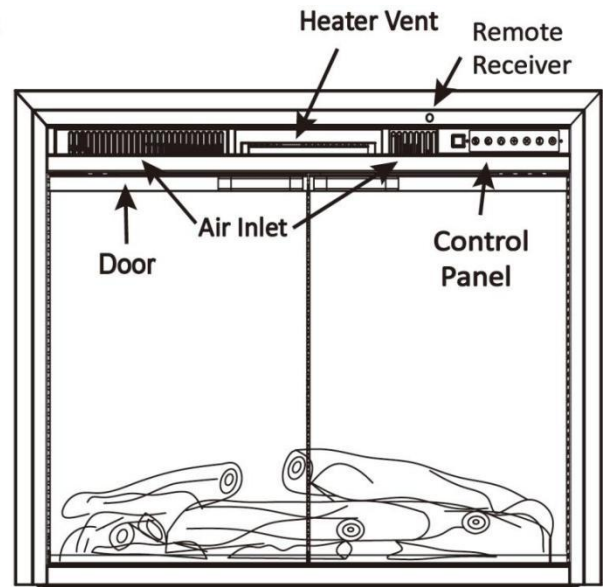

Style A



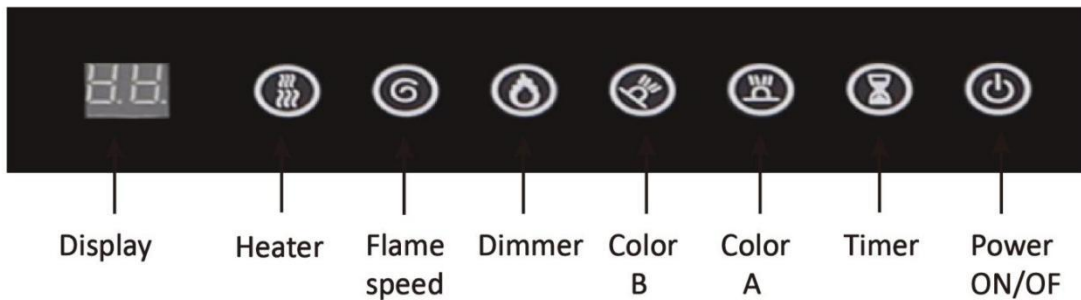



Style B

Control Panel



POWER		Turn the appliance ON/OFF. NOTE: Make sure the Main Power Switch on the upper right (left) of fireplace is turned on before operating.
DIMMER		Control Flame brightness. 5 Settings: (L1-L2-L3-L4-L5) Flame dims from L1 to L5. L5 is the brightest setting. NOTE: Long-press the "DIMMER" button for 6 seconds, the appliance will go into the sleep mode. All the lights are off, and the heating function goes on. Long-press for 6 seconds again, the appliance will be back to normal mode.
TIMER		Control the Timer. 8 Settings: (1h, 2h, 3h, 4h, 5h, 6h, 7h, 8h) Press the button until reach the desired setting.

<p>FLAME SPEED</p>		<p>Control Flame speed. 5 Settings: (U1-U2-U3-U4-U5) Flame speed from U1 to U5. U5 is the fastest setting.</p>
<p>HEATER</p>		<p>Control the Heater. Press button to initiate the heater. (OFF) no heater or blower. (-), heater blows warm air(750W) (--), heater blows hot air(1500W) NOTE: Heater functions cycle from (OFF) (-)(--)</p>
<p>COLOR A</p>		<p>Style A : Control the flame color. 4 Settings: 1-red, 2-yellow, 3-orange, 4- blue. Style B : Control the top decor light color. 3 Settings: 1-red, 2-orange, 3-blue. NOTE: When you press the button for 6 seconds until you hear a beep, the indicator will show digital "0", and the flame color and brightness will be changed automatically.</p>
<p>COLOR B</p>		<p>Style A : Control the flame bed color. 4 Settings: 1-red, 2-yellow, 3-red, 4-orange. Style B : Control the flame and flame bed color. 3 Settings: 1-red, 2-orange, 3-blue. NOTE: When you press the button for 6 seconds until you hear a beep, the indicator will show digital "0", and the flame color and brightness will be changed automatically.</p>

WARNING :Do not move or remove the mesh trim panel, when the appliance is plugged in and operating. This will cause the remote control and touch panel to no longer function.

NOTICE: When the heater is first turned on, a slight odor may be present. This is normal and should not occur again unless the heater is not used for a long period of time.

NOTICE: To improve operation, aim the remote control at the front of the fireplace. **DO NOT** press the buttons too quickly. Give the unit time to respond to each command.

4.3 REMOVE CONTROL

◆ Move the battery's transparent insulating piece away before using.



The battery must be recycled or disposed of properly. Check with your Local Authority or Retailer for recycling advice in your area.

5.0 TROUBLESHOOTING GUIDE

PROBLEM		SOLUTION
Heater doesn't turn on with the power switch.	1. Main power supply switch is off.	Turn the main power supply switch to "ON" position.
	2. Circuit breaker has tripped.	Too many appliances on this circuit. Be sure that electrical supply for this unit is an individual circuit.
	3. Heater is unplugged from wall outlet.	Make sure the power cord is plugged into a functioning and properly grounded 15 Amp 120V AC electrical outlet.
	4. Power cord or power plug are damaged.	Contact a qualified electrician to replace power cord.
	5. Power outlet for power plug prong is loose.	Check the power outlet and replace with a new one.
	6. Loose wiring.	Check all wiring for loose connections. Contact a qualified electrician.
Heater is on, but no flame or low flame intensity.	1. Heater switches in on, but Flame is not on.	Long-press the "DIMMER" button for 6 seconds, the appliance will go into sleep mode. All the lights off, the heating function goes on. Long-press for 6 seconds again, the appliance will back to normal mode.
	2. Flame Adjusting knob is at low setting.	Turn the knob to maximum setting.
	3. Loose wiring.	Check all wiring for loose connections. Contact a qualified electrician.

Flame are frozen	1. Flame element is not attached to the motor.	
	2. Rotation motor is defective.	
Excessive noise in the lower portion of the heater.	1. Flame element isn't seated properly	
	2. Motor is defective.	
Heater system doesn't come on.	1. Heater power switch is off.	Turn the heater power switch to the "ON" position.
	2. Heater system is overheated.	Maybe the heater is covered or air inlet or air outlet is blocked; remove the clothes or the blockage and turn off the power switch and unplug it. Wait 10 minutes, and then turn the heater on again.
	3. Loose wiring.	Check all wiring for loose connections. Contact a qualified electrician.
	4. The air inlet or air outlet is blocked completely.	Leave adequate space around the unit. Remove the blockage, on or in front of the air outlet.
"HEATER " switch has been flipped in the on position, but there is no airflow.	1. The heater system is overheated. Temperature Limit thermostat is cutoff.	Check the air inlet and outlet. Turn off the power switch and unplug it. Wait 10 minutes, and then turn the heater on again.
	2. Fan motor is defective.	
	3. Fan blower is balanced badly.	
	4. The "POWER" and the "HEATER" switches are not turned on.	Turn these two switches on.
The fan runs but no heat is coming out.	1. Loose wiring.	
	2. Bad heating element.	
	3. Build up of dirt on the fans	Clean all fans.
	4. Heater fan is defective.	
The remote control does not work.	1. The battery is not properly installed.	Make sure the battery is properly installed. Move the battery's transparent insulating piece away before using.
	2. Not pointing to the right position.	Aim the remote control at the receiver.
	3. Have an obstacle in front of the	Remove objects that may be in the way. Items between

	machine.	the remote control and the remote control receiver will block the signal.
	4. Press the remote control buttons too quickly.	Don't press the remote control buttons too quickly. Give the unit time to respond to your commands.
There is an odor coming from the heater.	The heater may emit a slight, harmless odor when first used. This is a normal condition caused by the initial heating of the internal parts and will not occur again.	

NOTE: For most functional problems, you can unplug the plug, wait for 10 minutes, and plug it again, the machine will reset to the initial status (original system state).

If the problem is still not solved, feel free to contact us

6.0 MAINTENANCE



DISCONNECT POWER AND ALLOW THE HEATER TO COOL BEFORE ATTEMPTING ANY MAINTENANCE OR CLEANING TO REDUCE THE RISK OF FIRE, ELECTRIC SHOCK OR DAMAGE TO THE PERSON.

THE FIREPLACE SHOULD NOT BE OPERATED WITH AN ACCUMULATION OF DUST OR DIRT ON OR IN THE UNIT, AS THIS CAN CAUSE A BUILD-UP OF HEAT AND SUBSEQUENT EVENTUAL DAMAGE. FOR THIS REASON, THE HEATER MUST BE INSPECTED REGULARLY, DEPENDING ON CONDITIONS, AND AT LEAST AT YEARLY INTERVALS.

6.1 PARTIALLY REFLECTIVE GLASS CLEANING

The partially reflective glass is cleaned in the factory during the assembly operation. During shipment, installation, handling, etc., the partially reflective glass may collect dust particles; these can be removed by dusting lightly with a clean dry cloth.

To remove fingerprints or other marks, the partially reflective glass can be cleaned with a damp cloth. The partially reflective glass should be completely dried with a lint-free cloth to prevent water spots. To prevent scratching, do not use abrasive cleaners.

6.2 SCHEMATIC DIAGRAM

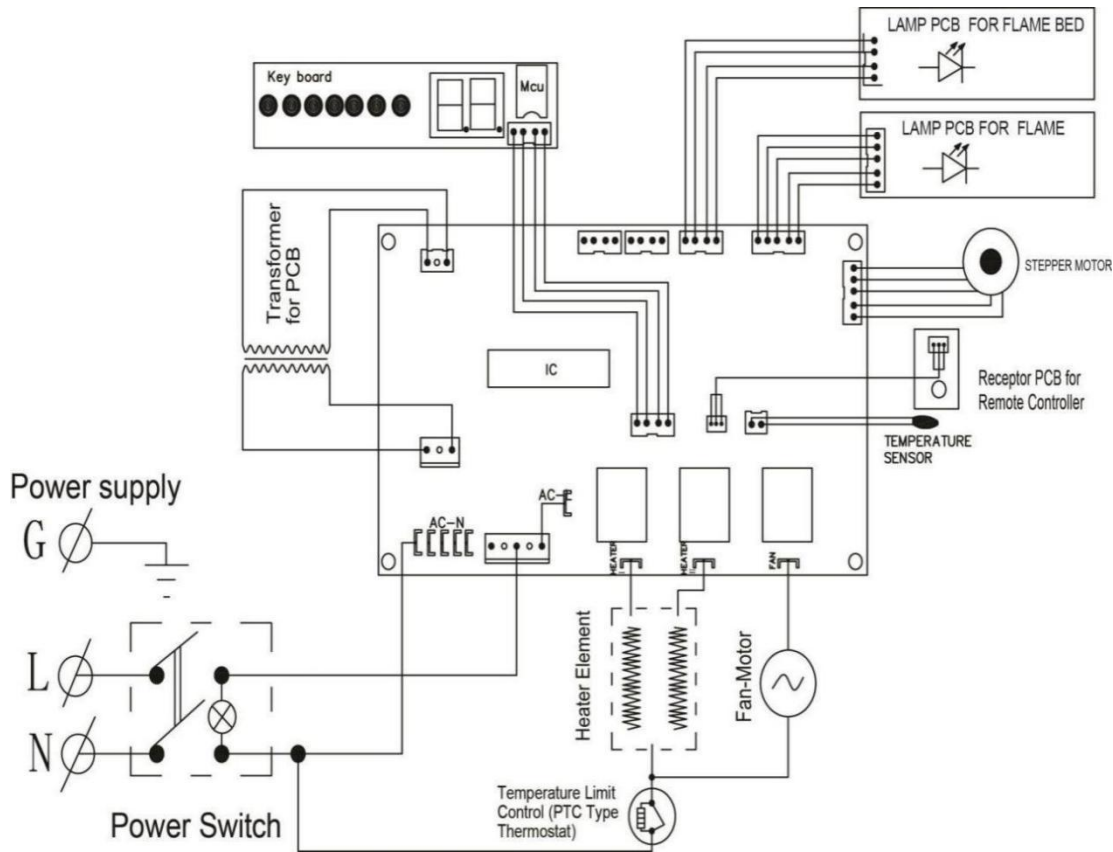

7.0 LIMITED WARRANTY

This warrants to the original purchaser that this product is free from defects in material and workmanship as of the date of purchase and that it will, under normal use and proper care, remain so for one year from the date of purchase. Missing or initially defective parts will be replaced free of charge during the period of this limited warranty. If parts are unavailable, a comparable replacement or refund will be given. **The original dated sales receipt is required for all warranty claims.** This warranty does not cover damage which has occurred during transport from the point of purchase to the consumer's home. This warranty does not cover glass, light bulbs, batteries, transportation, labor, or other issues not associated with the manufacture of the product.

This product is for residential use only. Any and all commercial use of this product voids all warranties, and frees the manufacturer from all liability.

Read and understand all assembly and operating instructions, and all safety information and warnings, before use. The following will void this warranty: Damage caused from tampering with, modifying, or altering the fireplace insert in any manner; Damage due to incorrect assembly, improper care, misuse, or abuse; Damage from being used with the wrong power source; Water damage; Damage caused from this insert being used outdoors; Damage caused from this insert being used for excessive periods; Damage caused by the insert being used in a commercial application; Damage from use as a primary heat source; Other misuse or abuse not specifically listed herein.

This product is not intended to be used as a primary heat source. It is for supplemental heating purposes only.