

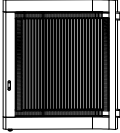

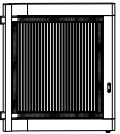



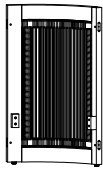
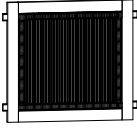
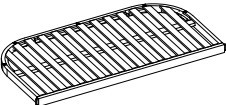
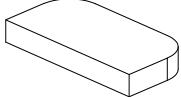

Hello! Please read these important attentions...

Please put a thick carpet on the ground to protect the furniture finish and corners. During the installation process, **DON' T** fasten screws tight 100% at a time.

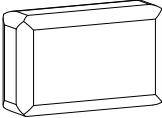
ASSEMBLY INSTRUCTIONS

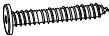
NUMBER	COMPONENT	QUANTITY
A	 <p>LEG FRAME 1</p>	1PC
B	 <p>LEG FRAME 2</p>	1PC
C	 <p>LEG FRAME 3</p>	1PC
D	 <p>LEG FRAME 4</p>	1PC
E	 <p>LEG FRAME 5</p>	1PC
F	 <p>SEAT</p>	1PC
G	 <p>SEAT CUSHION</p>	1PC

ASSEMBLY INSTRUCTIONS

NUMBER	COMPONENT	QUANTITY
H	 BACK CUSHION	2PCS
I	 SCREW M7x70mm	4PCS
J	 SCREW M6x40mm	4PCS
K	 SCREW M4x20mm	8PCS
L	 PLASTIC LID	4PCS
M	 M4	2PCS

NOTE: The accessory pack does not include a screwdriver. Please prepare a screwdriver before you assemble.

ASSEMBLY INSTRUCTIONS

1

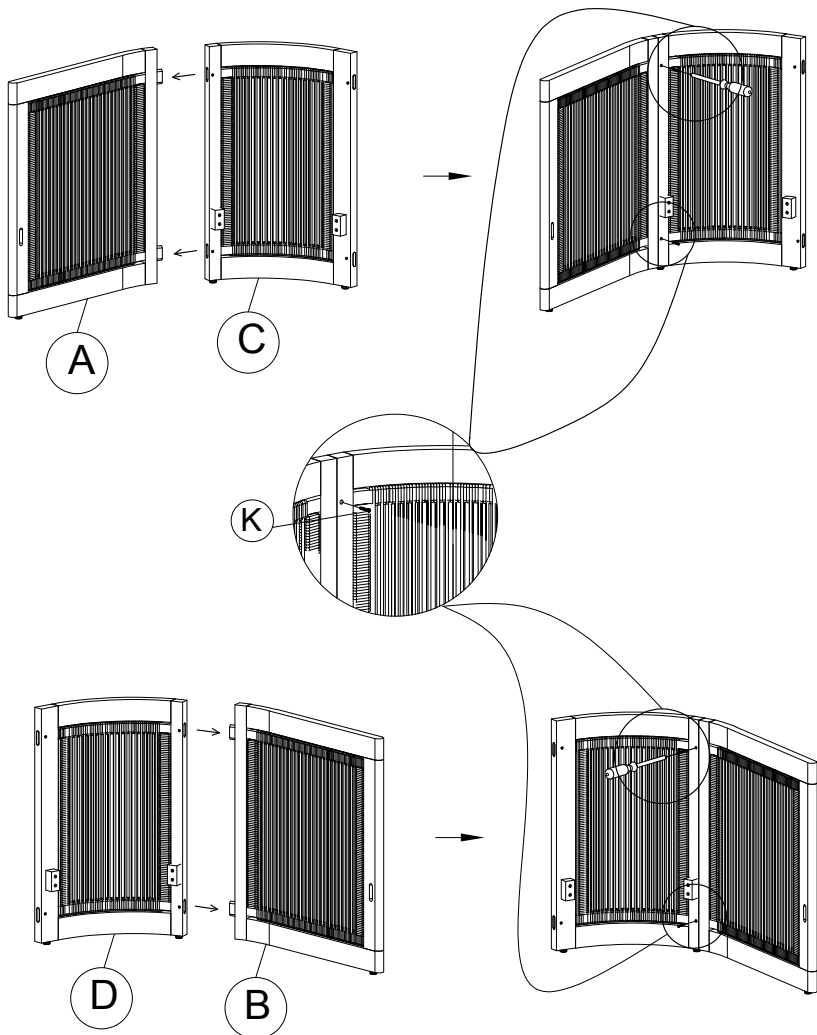

Use the Screw M4X20 MM (K) to connect The Leg Frame 1 (A) to The Leg Frame 3 (C) to create the Right Leg Cluster.

Use the Screw M4X20 MM (K) to connect The Leg Frame 1 (B) to The Leg Frame 3 (D) to create the Left Leg Cluster

ASSEMBLY INSTRUCTIONS

2

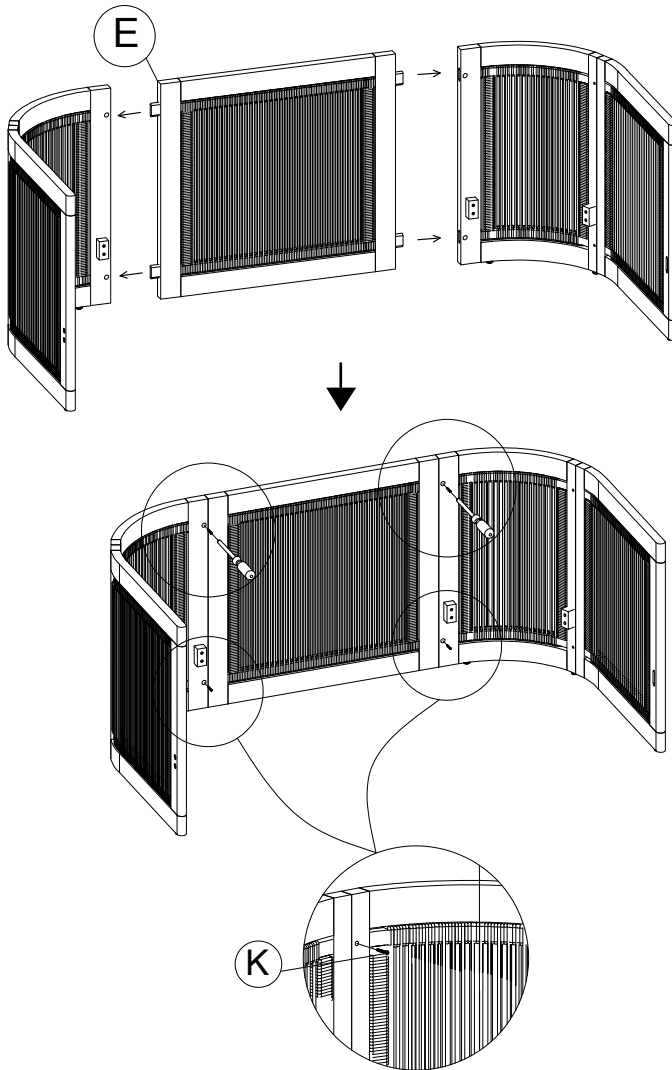

Use the Screw M4X20 MM (K) to connect the Right Leg Cluster and the Left Leg Cluster to the Leg Frame 5 (E) together to create the Leg Cluster.

ASSEMBLY INSTRUCTIONS

3

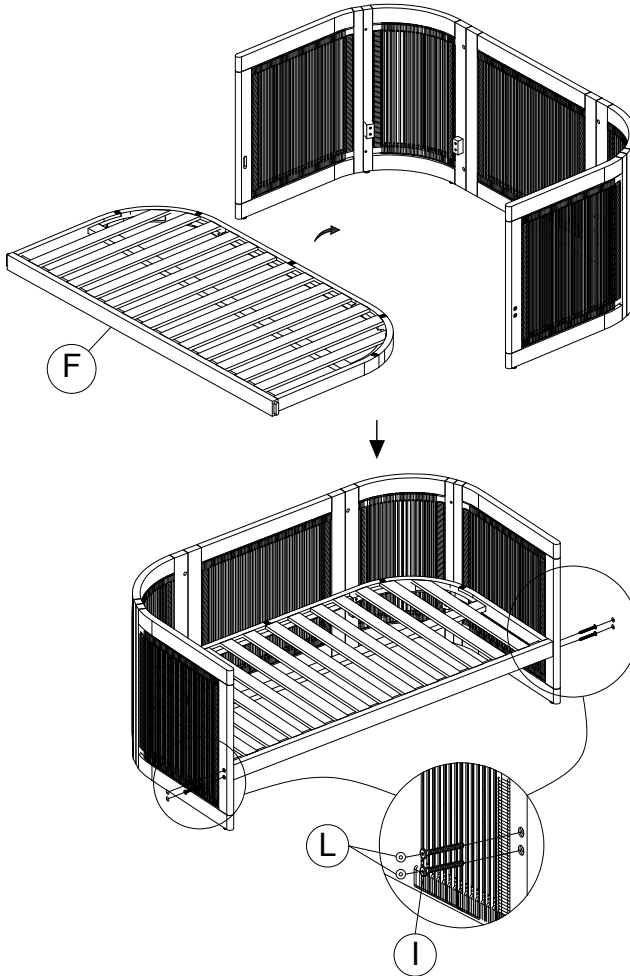

Use the Screws M7X70 MM to connect the Seat (F) to the Leg Cluster, and use the Plastic Lid (L) to cover the Heads.

ASSEMBLY INSTRUCTIONS

4

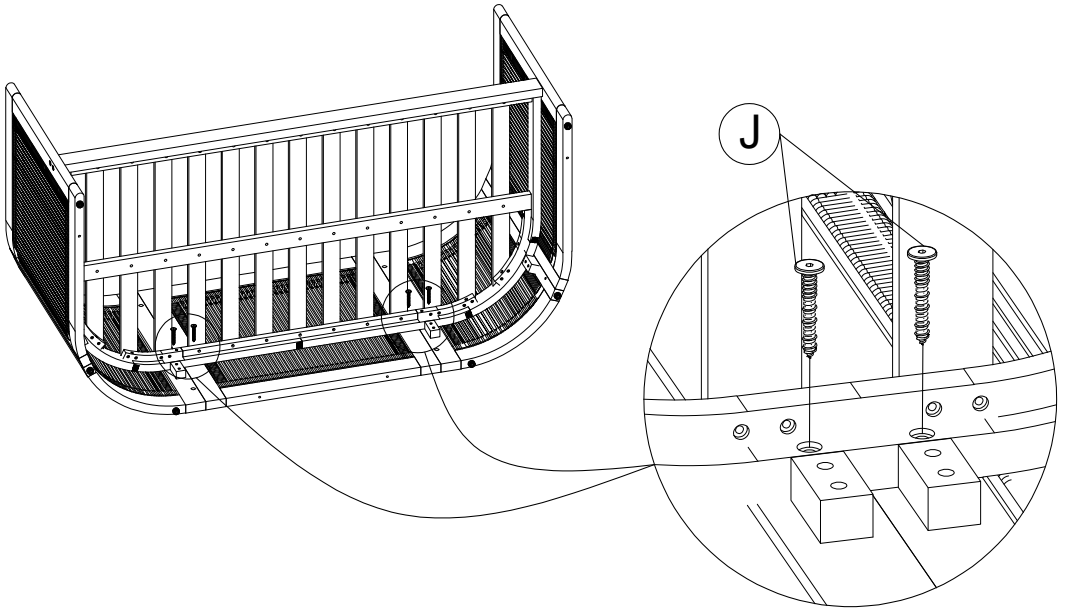

Use the Screws M6X40 MM (J) to connect the Leg Cluster to the Back of the Seat below.

ASSEMBLY INSTRUCTIONS

5

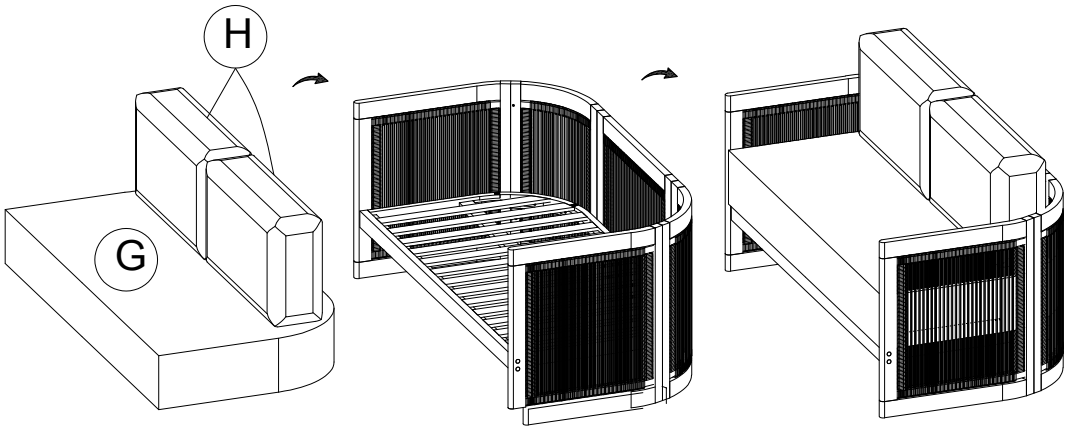

Put the Back and Seat Cushion on the Sofa.

ASSEMBLY INSTRUCTIONS

6

