

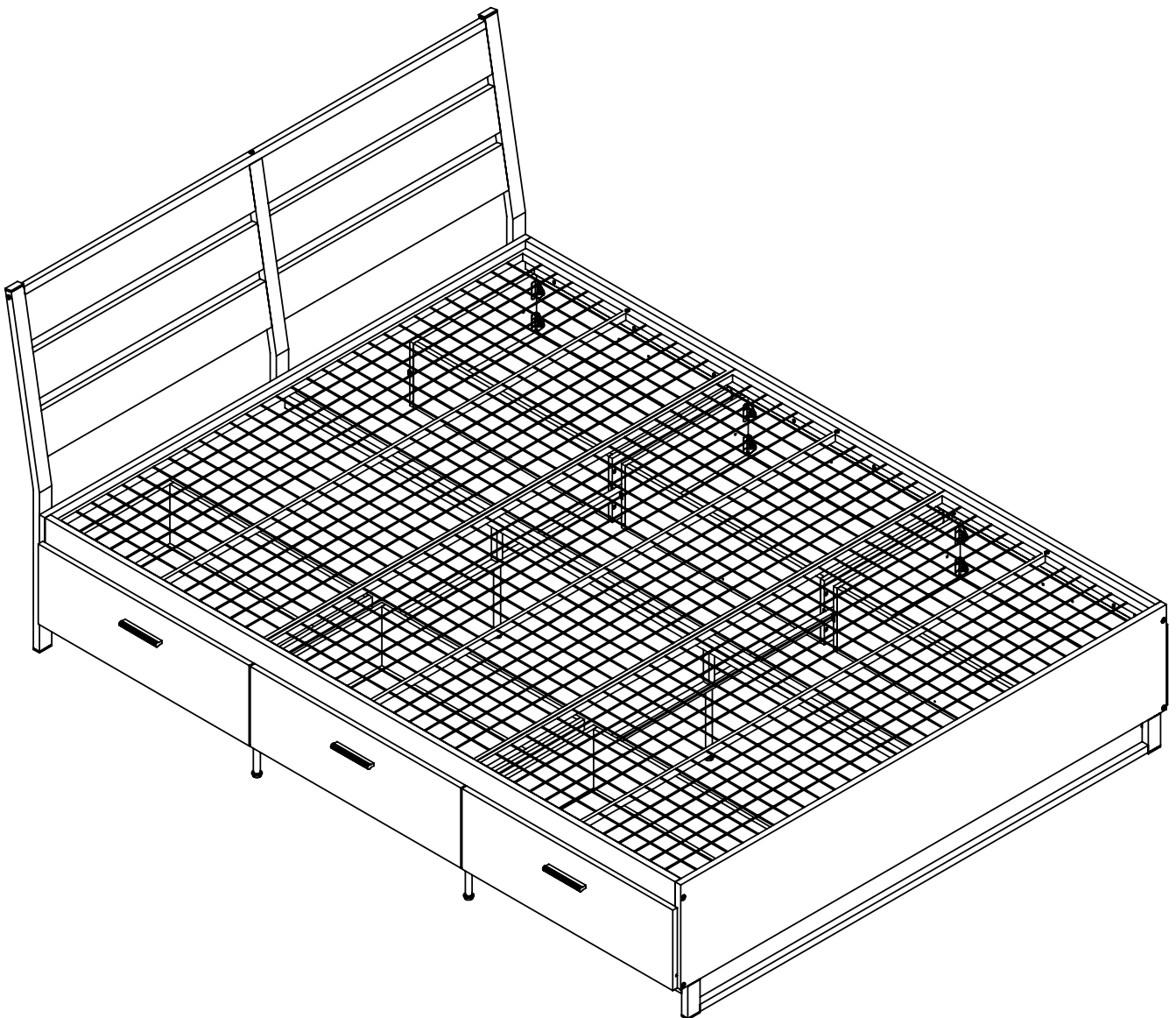

ASSEMBLY INSTRUCTION FOR ACME FURNITURE



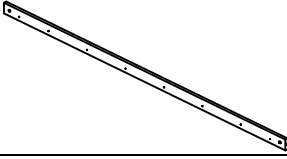
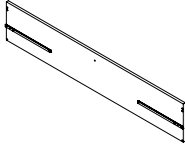
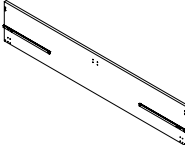
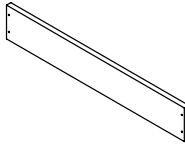
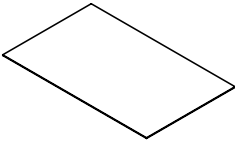
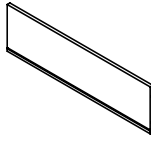
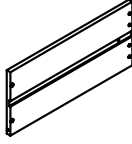
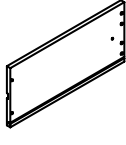
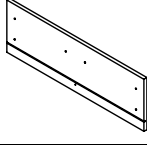
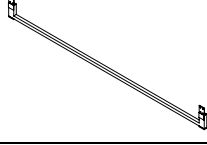

MODEL#24257 24258 24260 24261

Thank you for purchasing the quality product. Be sure to check all packing material carefully for small parts which may have come loose inside the carton during shipment. Separate, identify and count all parts and metal hardware. Compare with all parts list to be sure all parts are present. If any part(s) are missing or damaged, please contact your local furniture dealer. For efficient and speedy service, please indicate the model number and code letter of part(s) needed.





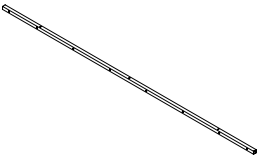
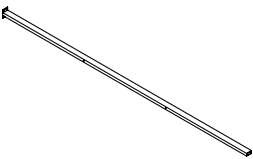
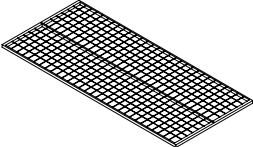
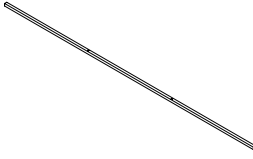
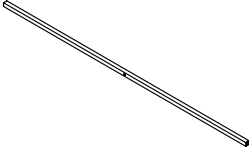
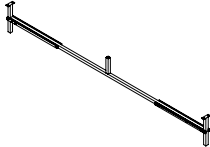
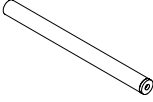







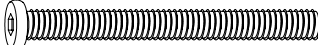





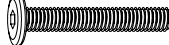

















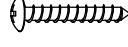



** Do not fully tighten screws until fully assembled **

COMPONENT PARTS			
DESCRIPTION	PART NAME	QTY(PCS)	BOX
①	SIDE PANEL 	2	24258EK-HF 24261Q-HF
②	HEADBOARD 	1	24258EK-HF 24261Q-HF
③	FOOTBOARD 	1	24258EK-HF 24261Q-HF
④	UPPER HEADBOARD 	6	24258EK-HF 24261Q-HF
⑤	(DRAWER) BOTTOM PANEL 	6	24258EK-HF 24261Q-HF
⑥	(DRAWER) REAR PANEL 	6	24257EK-DRW 24260Q-DRW
⑦	(DRAWER) SIDE PANEL-LEFT 	6	24257EK-DRW 24260Q-DRW
⑧	(DRAWER) SIDE PANEL-RIGHT 	6	24257EK-DRW 24260Q-DRW
⑨	(DRAWER) FRONT PANEL 	6	24257EK-DRW 24260Q-DRW
⑩	IRON FRAME OF BED END 	1	24258EK-HF 24261Q-HF
⑪	IRON TUBE OF BED HEAD-RIGHT 	1	24258EK-HF 24261Q-HF

⑫	IRON TUBE OF BED HEAD-LEFT		1	24258EK-HF 24261Q-HF
⑬	IRON TUBE OF BED HEAD-MIDDLE		1	24258EK-HF 24261Q-HF
⑭	IRON TUBE OF BED SIDE		2	24258EK-HF 24261Q-HF
⑮	SUPPORTIVE TUBE FOR BEDSTEAD		1	24258EK-HF 24261Q-HF
⑯	BEDSTEAD		3	24257EK-DRW 24260Q-DRW
⑰	SUPPORTIVE TUBE FOR BEDSIDE		2	24258EK-HF 24261Q-HF
⑱	IRON TUBE FOR UPPER HEADBOARD		1	24258EK-HF 24261Q-HF
⑲	H-SHAPE TUBE FOR DRAWER		2	24258EK-HF 24261Q-HF
⑳	SUPPORTIVE TUBE FOR H-SHAPE TUBE(LARGE)		2	24258EK-HF 24261Q-HF
㉑	SUPPORTIVE TUBE FOR H-SHAPE TUBE(SMALL)		4	24258EK-HF 24261Q-HF
㉒	DRAWER BOTTOM FASTENING		6	24258EK-HF 24261Q-HF

HARDWARE REQUIRED

BOX: 24258EK-HF
24261Q-HF

		ALLEN BOLT	M8X80MM	2	PCS
		ALLEN BOLT	M8X63MM	2	PCS
		ALLEN BOLT	M6X63MM	8	PCS
		ALLEN BOLT	M6X38MM	2	PCS
		ALLEN BOLT	M6X12MM	8	PCS
		ALLEN BOLT	M6X35MM	6	PCS
		WOODEN PEG		4	PCS
		HANGER BOLTS	M6X50MM	6	PCS
		PHILLIPS SCREW	M4X35MM	40	PCS
		PHILLIPS SCREW	M6X14MM	36	PCS
		PHILLIPS SCREW	M4X15MM	24	PCS
		PHILLIPS SCREW	M4X12MM	12	PCS
		PHILLIPS SCREW	M4X21MM	12	PCS
		PHILLIPS SCREW	M4X12MM	12	PCS
		WASHER		12	PCS
		HANDLE		6	PCS
		CROSS HOLE NUT		4	PCS
		STUD		6	PCS
		ALLEN WRENCH		1	PCS
		ALLEN WRENCH		1	PCS

Attention

***Some number parts listed on the instruction sheet may not be in parts bag as they may already be assembled. Carefully check parts and packing materials prior to ordering replacements.

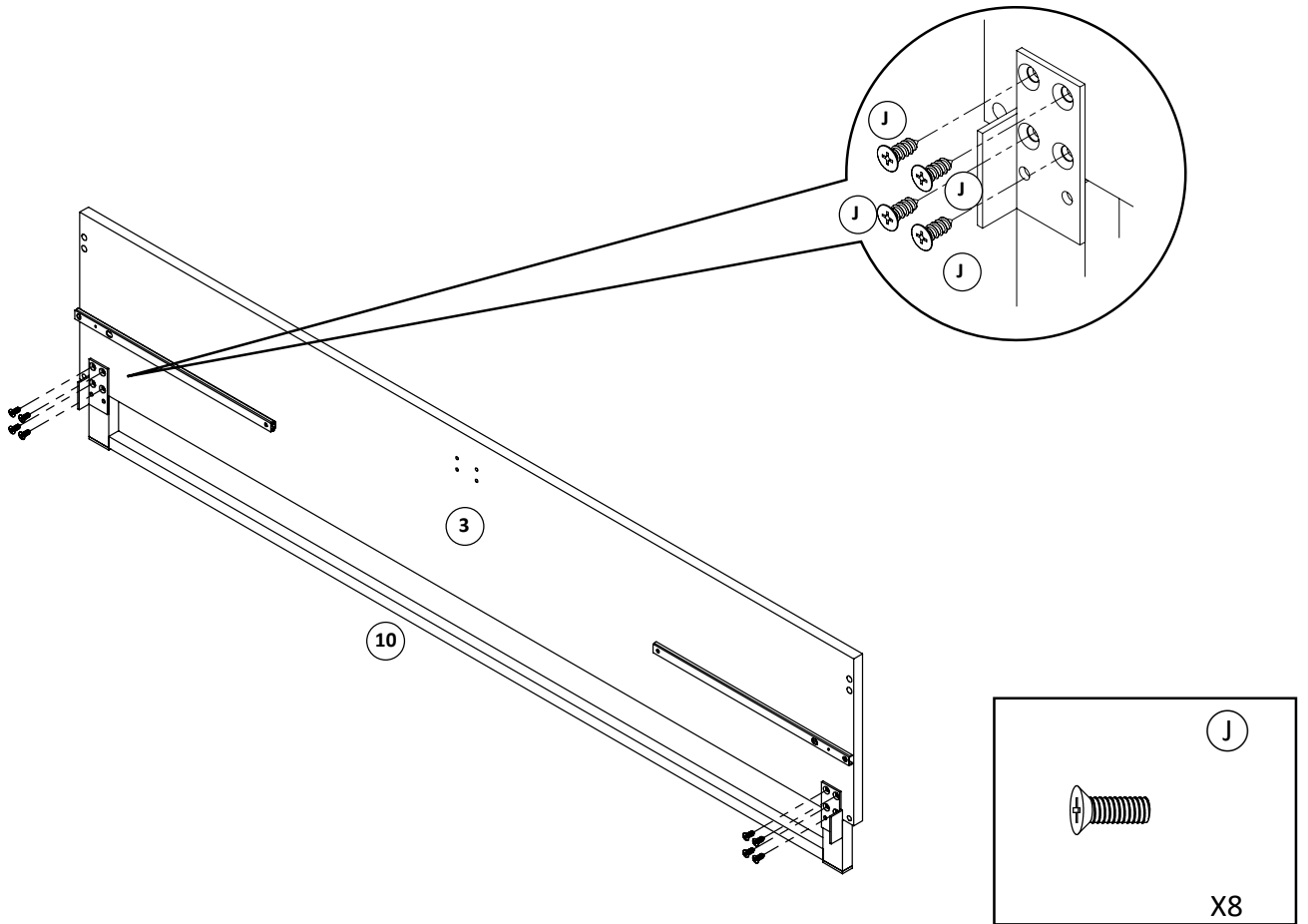
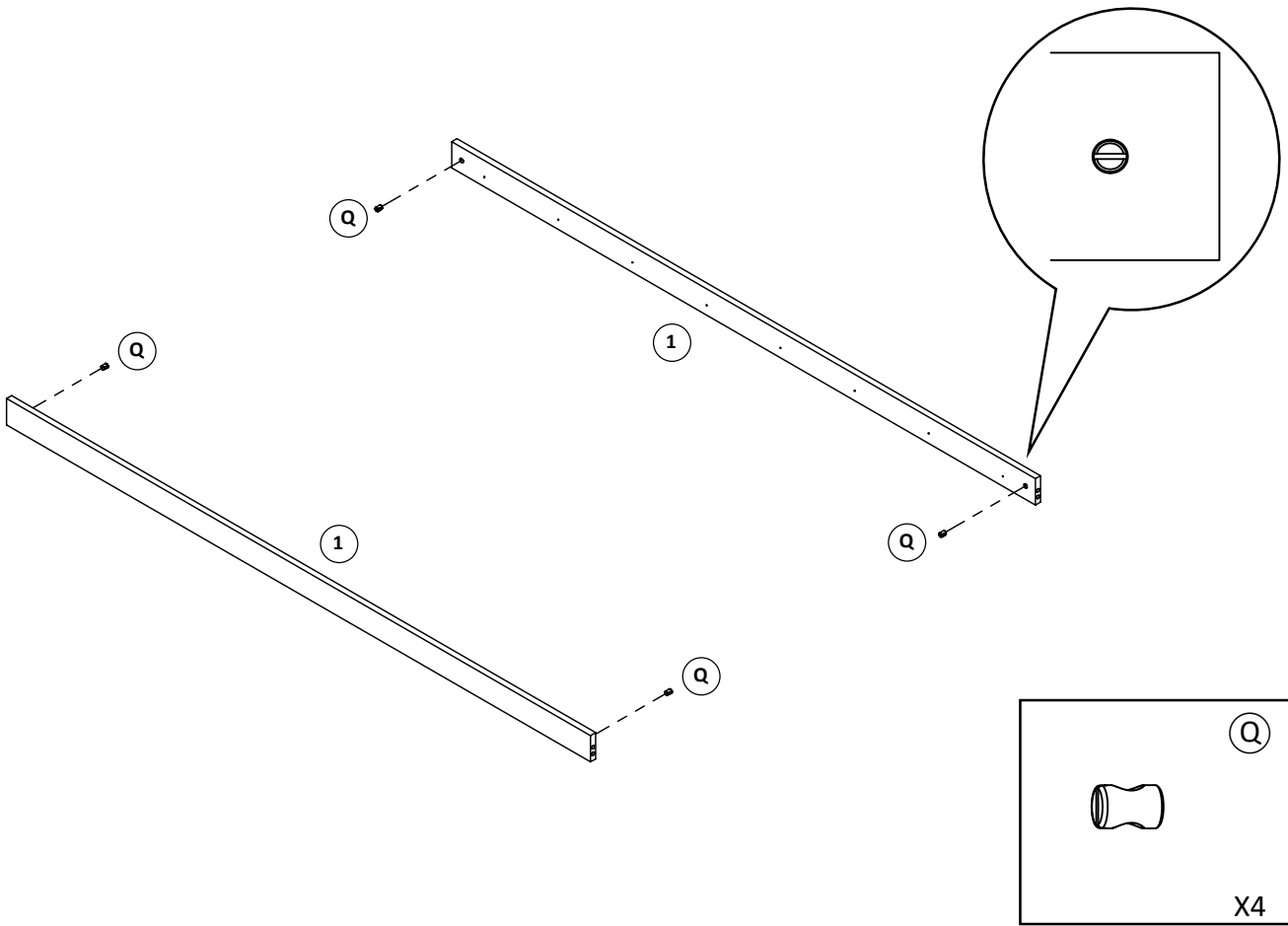

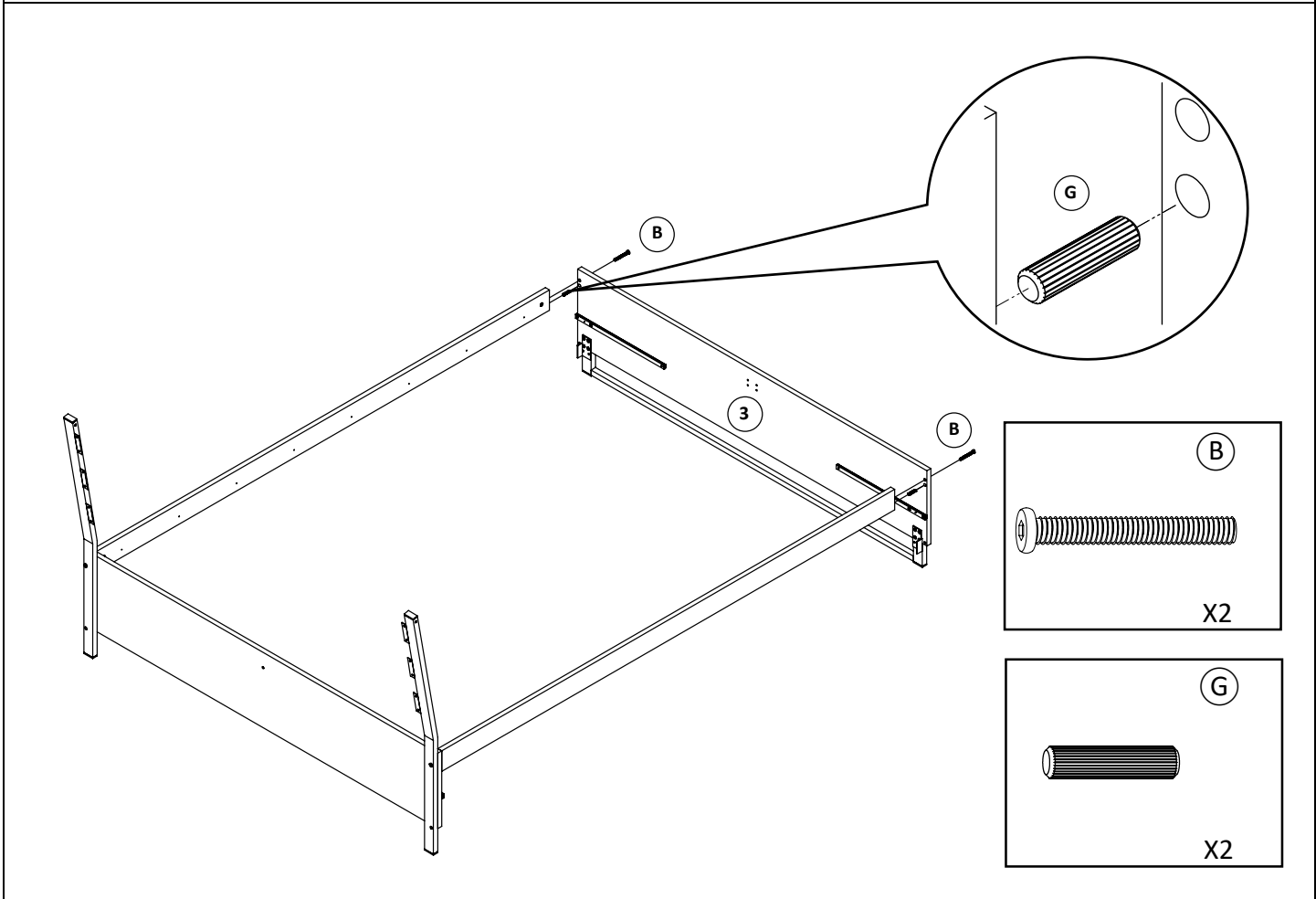
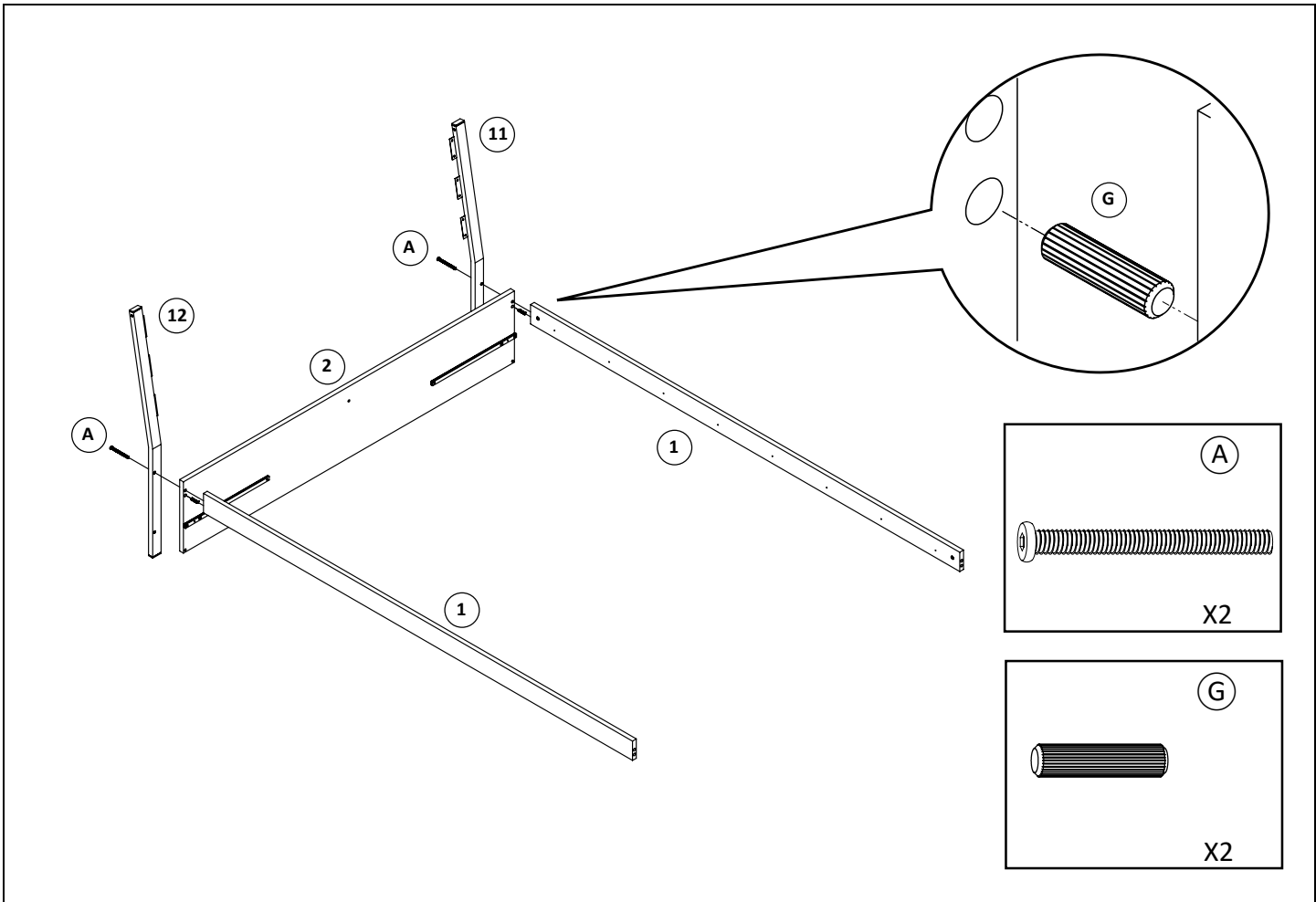

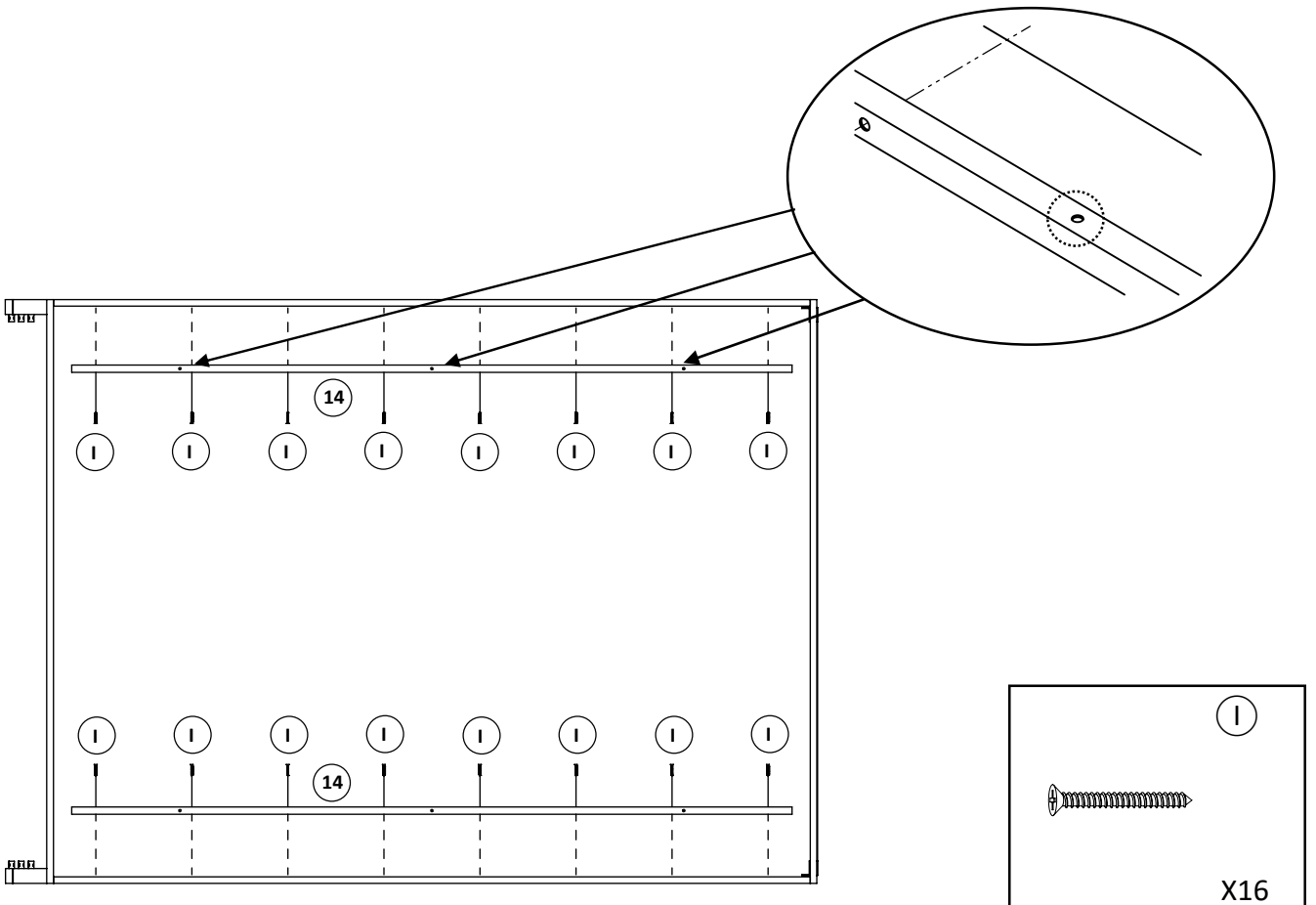
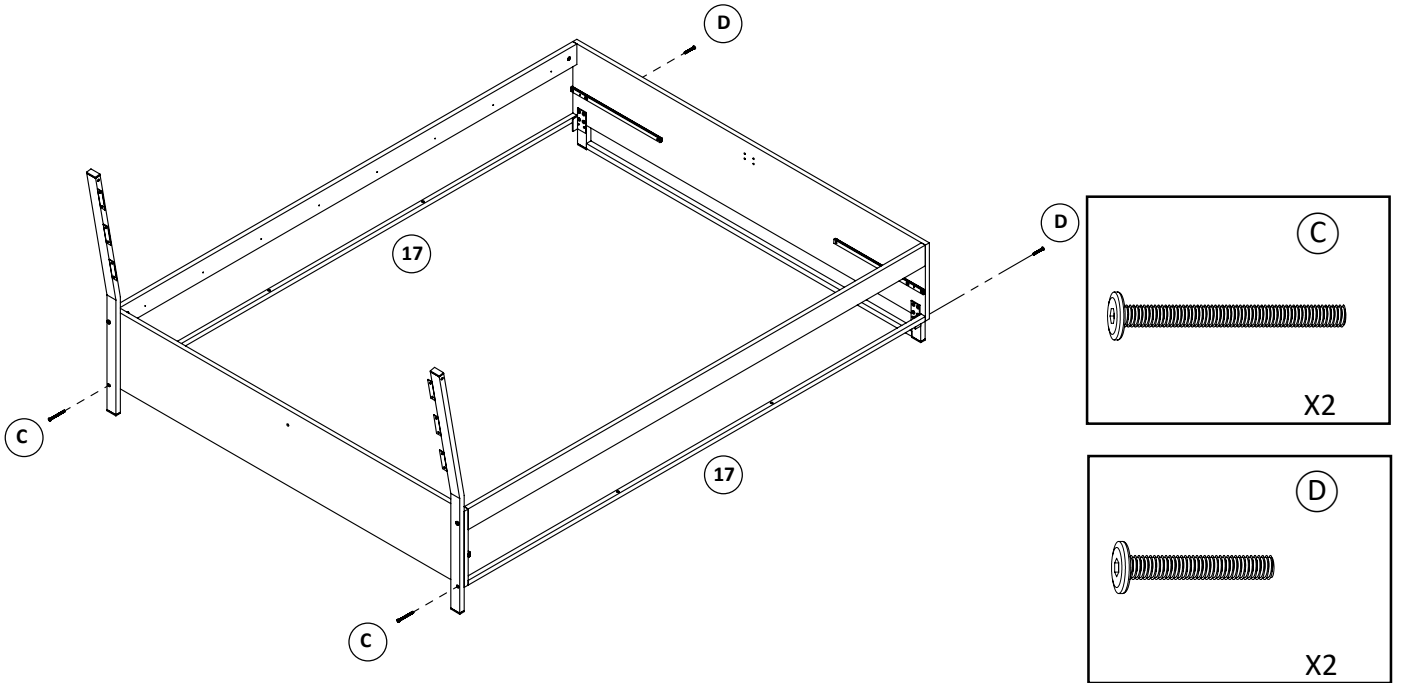

X2

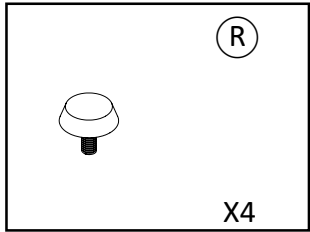
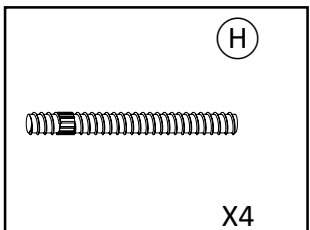
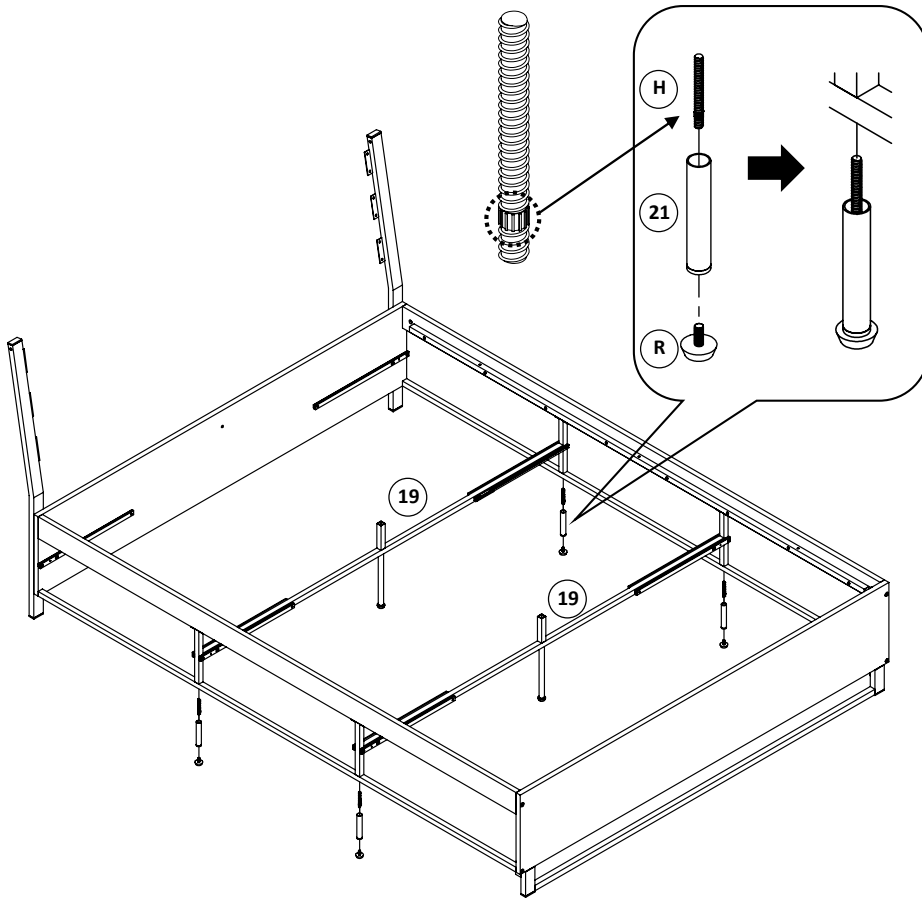
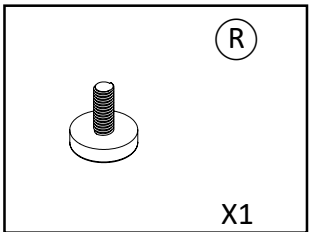
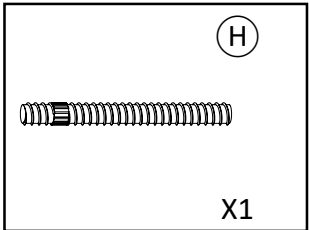
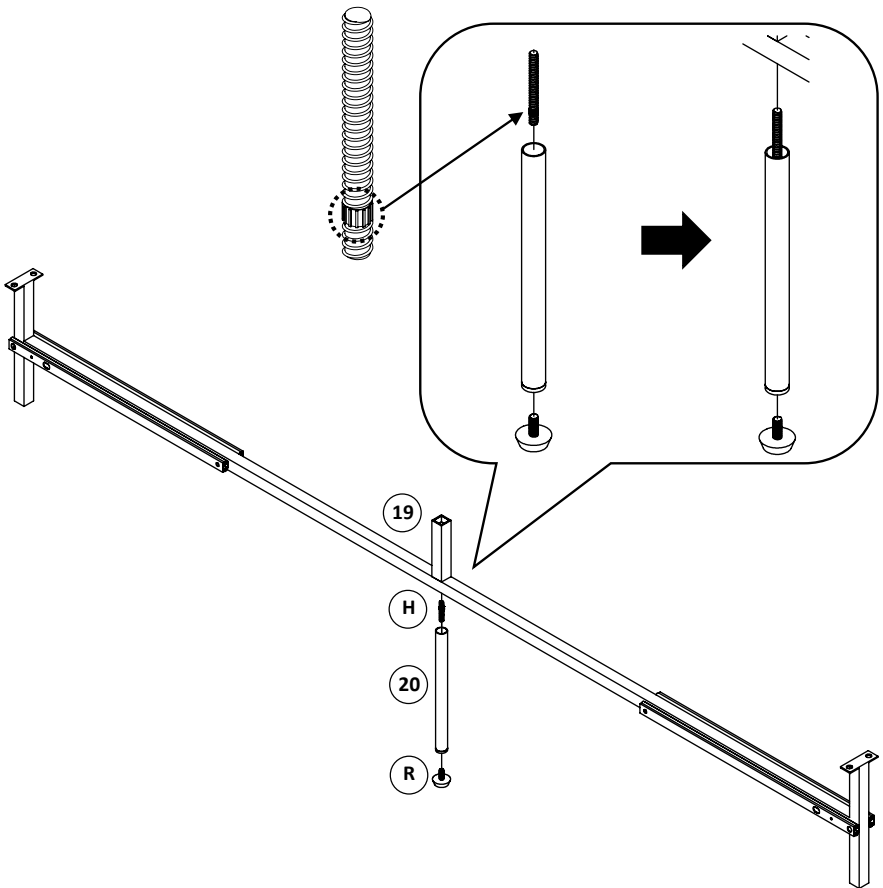

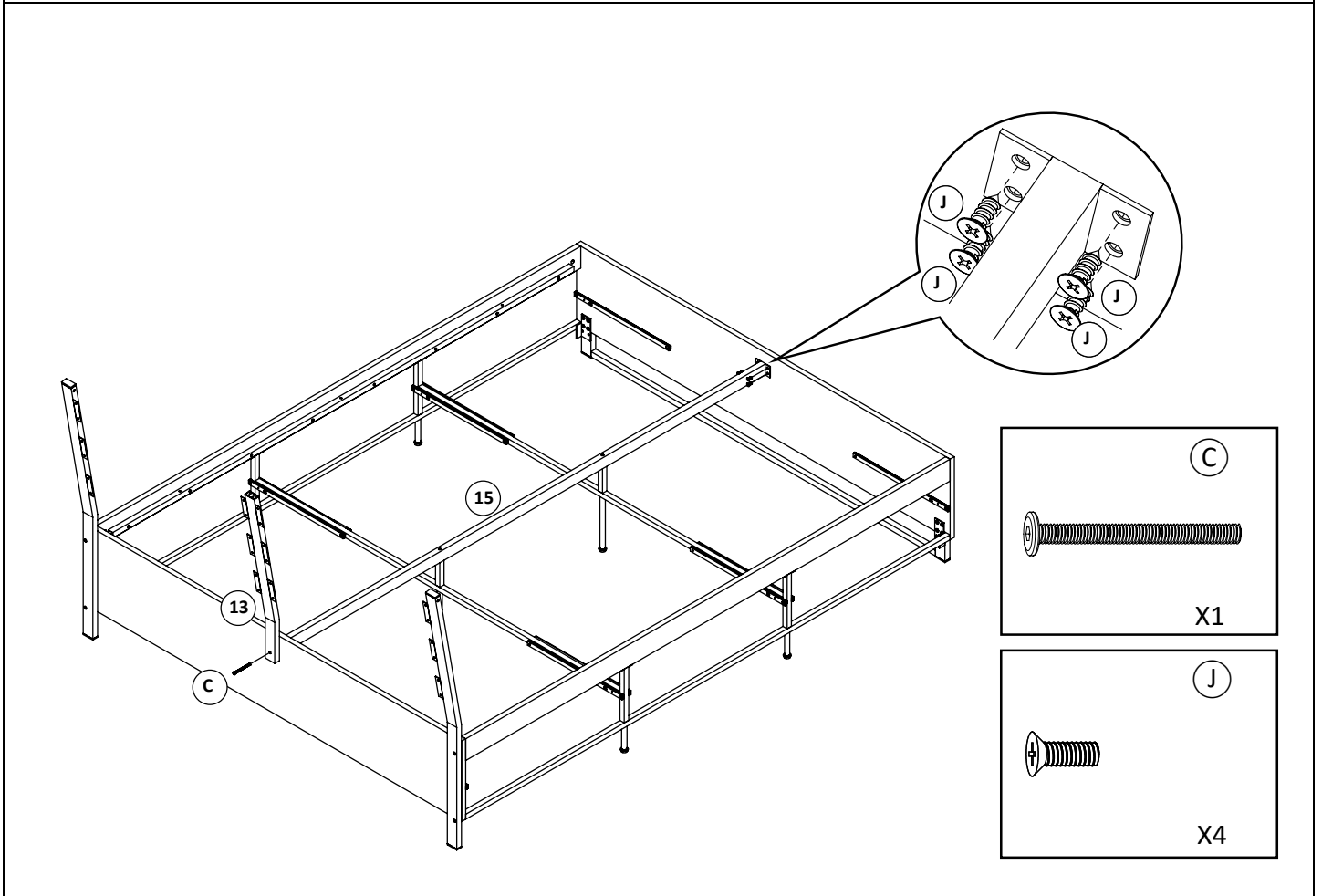
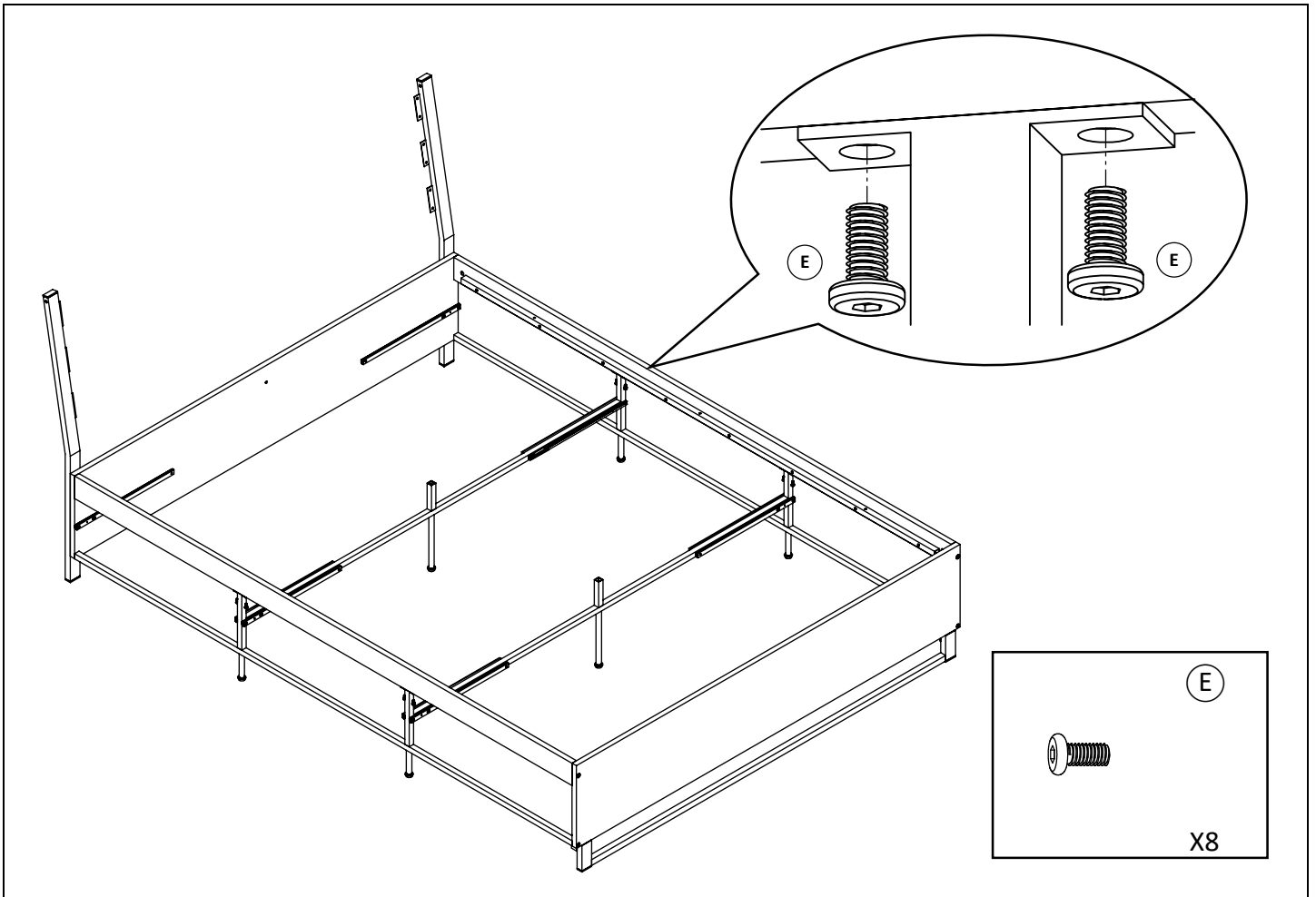

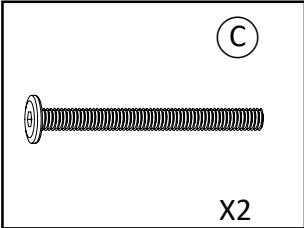
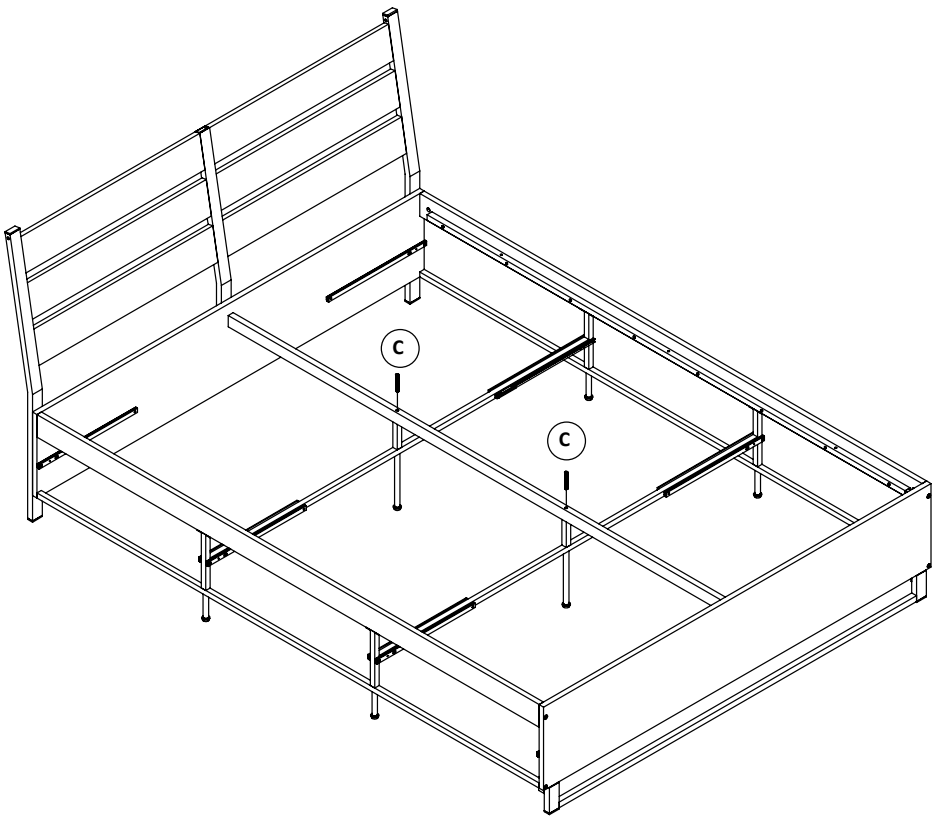
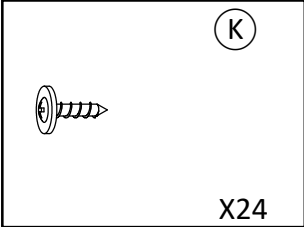
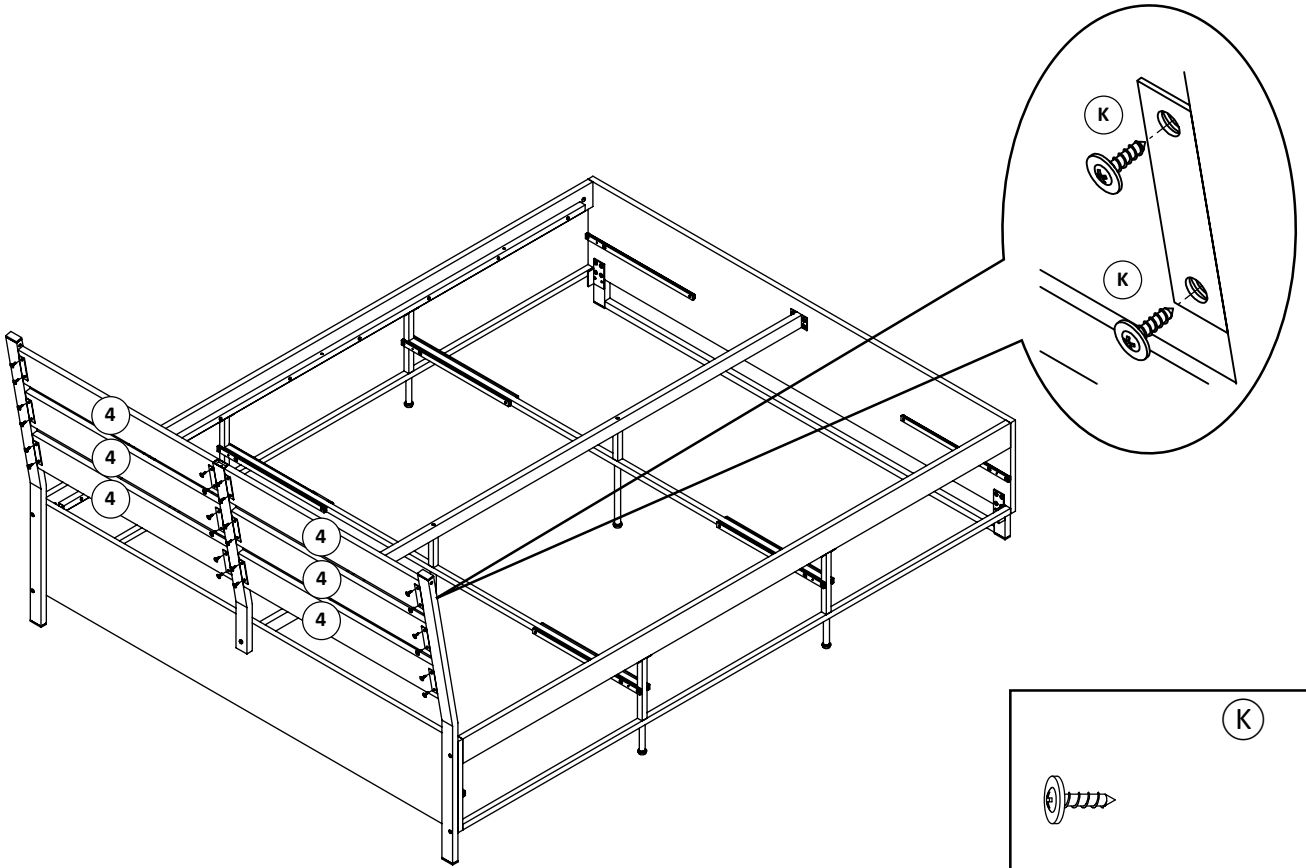

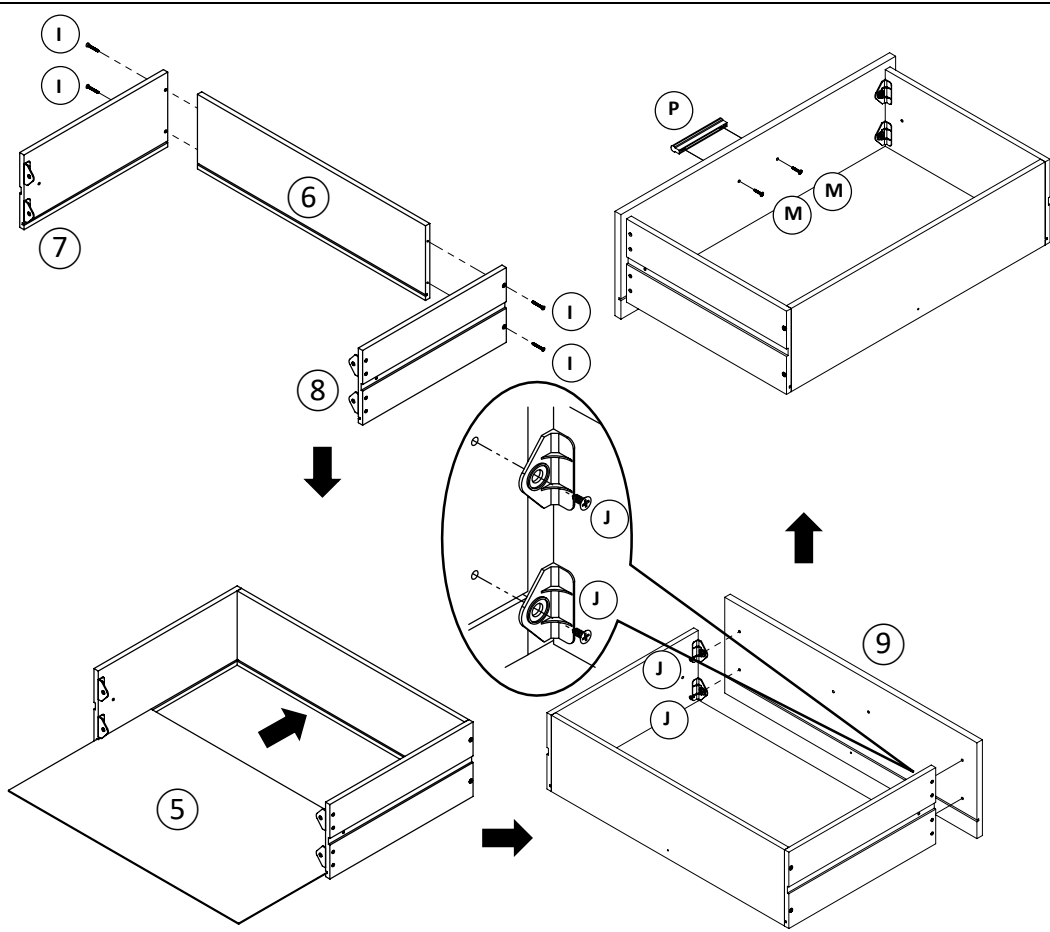
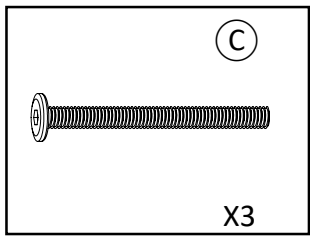
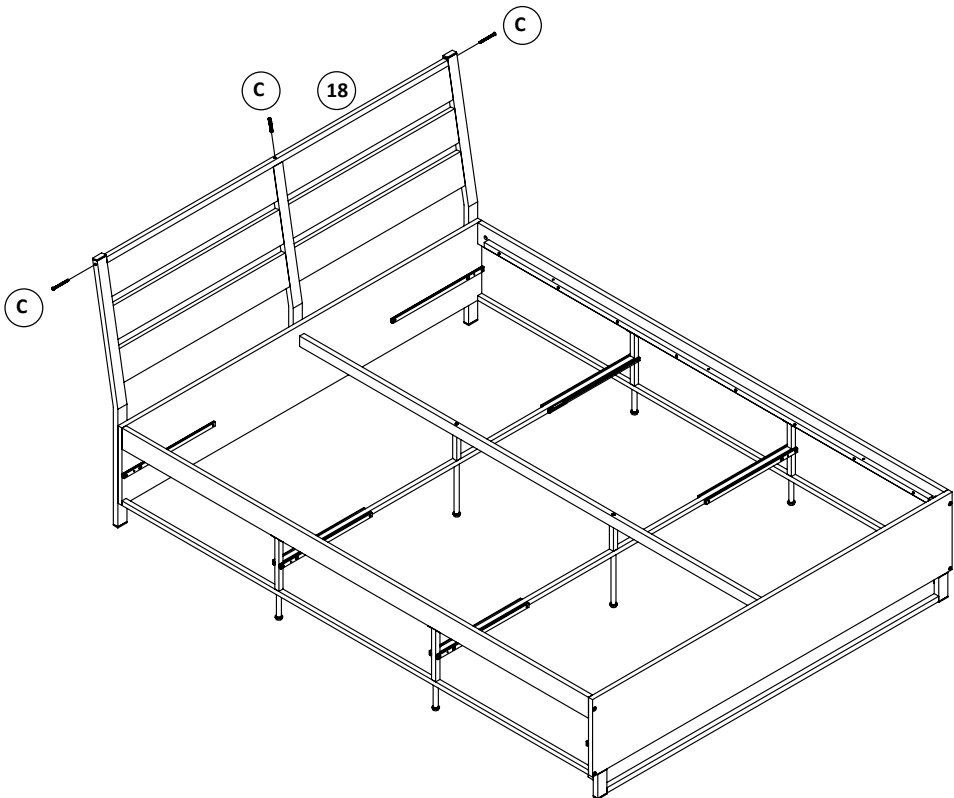

X6

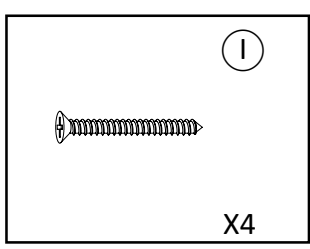
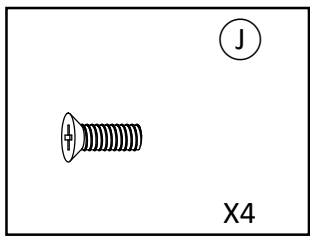
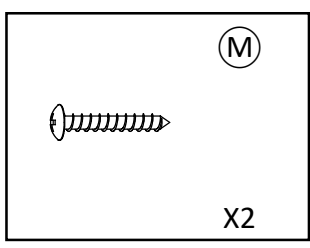

X6

