

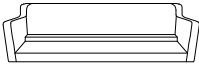





Assembly instructions for step 1/4:

- Warning:** Do not use a power drill. Use an L-shaped Allen key to tighten the screws.
- Warning:** Do not use a screwdriver to tighten the screws. Use your hands to push the screws into the pre-drilled holes.
- Time:** 30 minutes.
- Personnel:** 1 person.

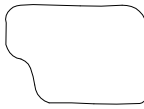
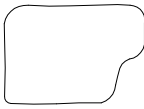
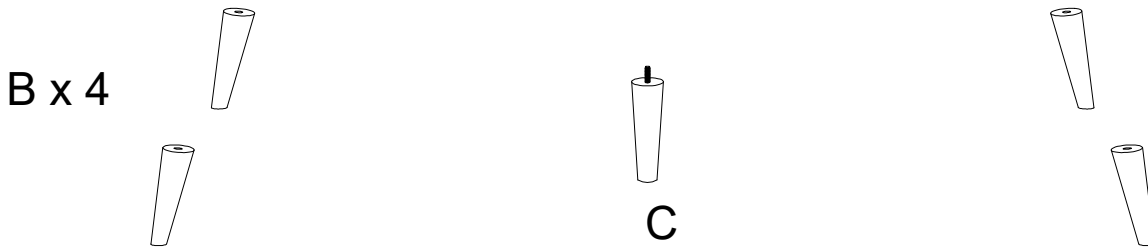
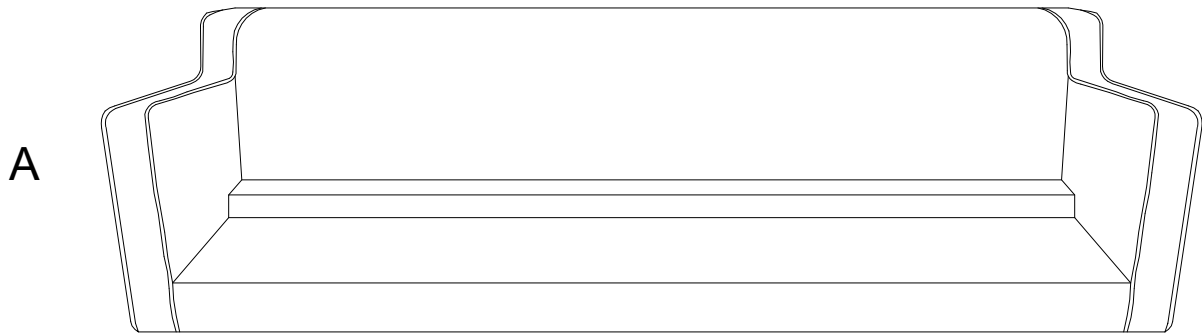
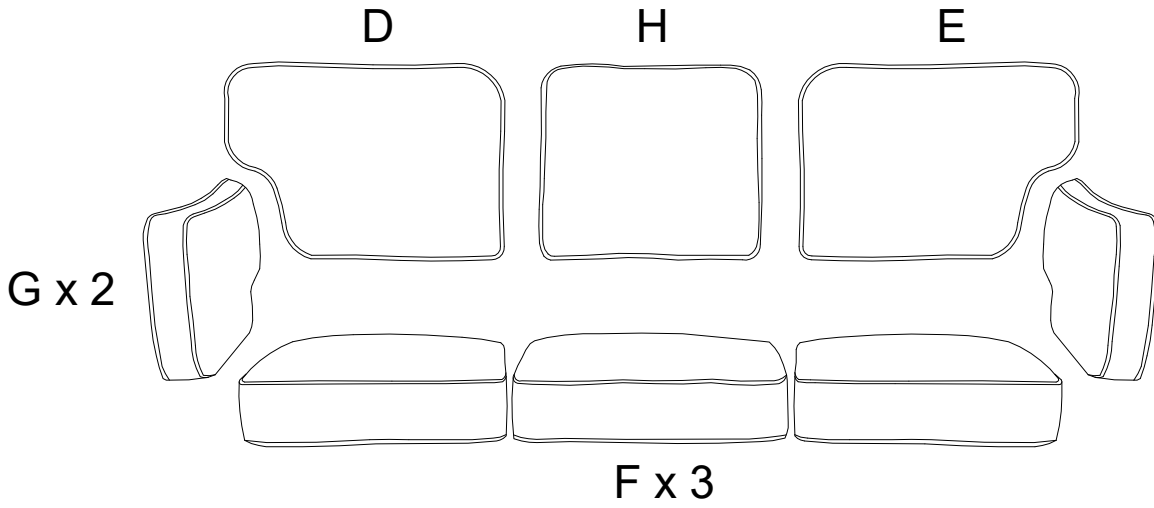
|                                                                                   |                                                                                   |                                                                                   |                                                                                    |                                                                                     |
|-----------------------------------------------------------------------------------|-----------------------------------------------------------------------------------|-----------------------------------------------------------------------------------|------------------------------------------------------------------------------------|-------------------------------------------------------------------------------------|
| <b>A</b>                                                                          | <b>B</b>                                                                          | <b>C</b>                                                                          | <b>D</b>                                                                           | <b>E</b>                                                                            |
|  |  |  |  |  |
| <b>x 1</b>                                                                        | <b>x 4</b>                                                                        | <b>x 1</b>                                                                        | <b>x 1</b>                                                                         | <b>x 1</b>                                                                          |

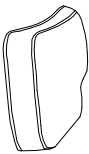
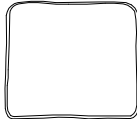
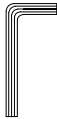



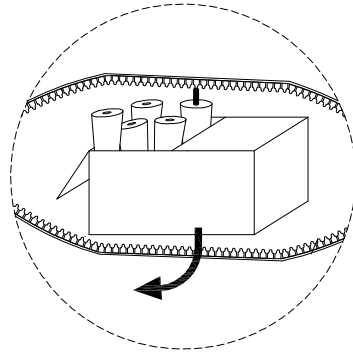
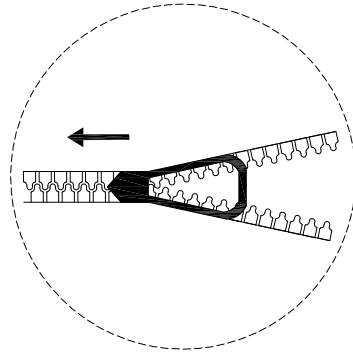
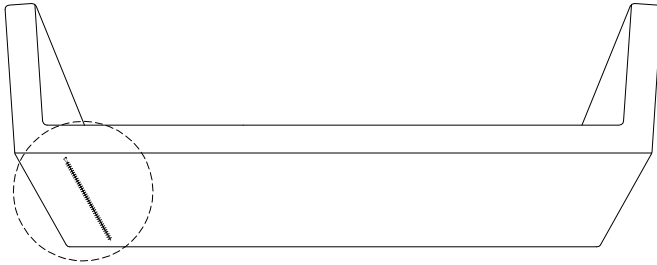

|                                                                                     |                                                                                     |                                                                                     |                                                                                     |                                                                                                     |                                                                                       |
|-------------------------------------------------------------------------------------|-------------------------------------------------------------------------------------|-------------------------------------------------------------------------------------|-------------------------------------------------------------------------------------|-----------------------------------------------------------------------------------------------------|---------------------------------------------------------------------------------------|
| <b>F</b>                                                                            | <b>G</b>                                                                            | <b>H</b>                                                                            | <b>I</b>                                                                            | <b>J</b>                                                                                            | <b>K</b>                                                                              |
|  |  |  |  |  M8<br>x<br>65 |  |
| <b>x 3</b>                                                                          | <b>x 2</b>                                                                          | <b>x 1</b>                                                                          | <b>x 1</b>                                                                          | <b>x 4</b>                                                                                          | <b>x 4</b>                                                                            |

!

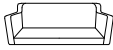

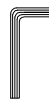

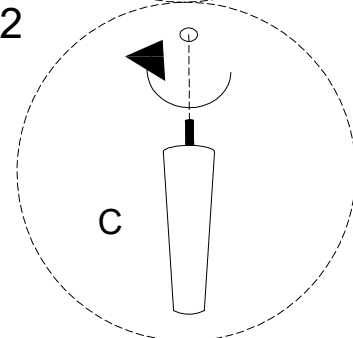
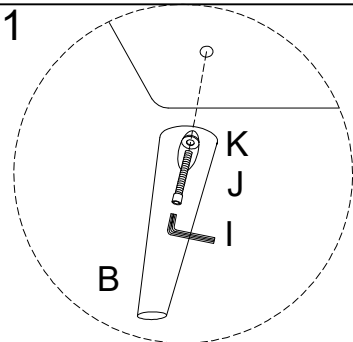
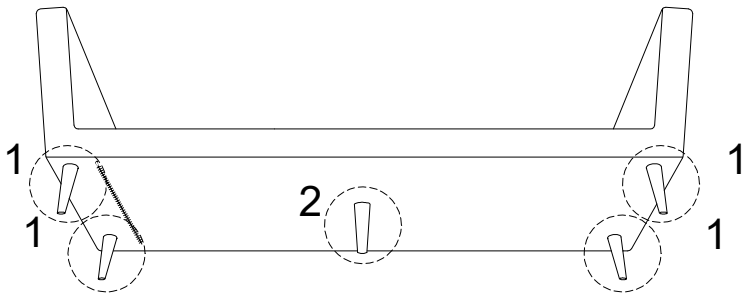

1

|                                                                                                        |                                                                                                        |                                                                                                        |                                                                                                         |                                                                                                                     |                                                                                                          |
|--------------------------------------------------------------------------------------------------------|--------------------------------------------------------------------------------------------------------|--------------------------------------------------------------------------------------------------------|---------------------------------------------------------------------------------------------------------|---------------------------------------------------------------------------------------------------------------------|----------------------------------------------------------------------------------------------------------|
| <b>A</b><br><br>x 1 | <b>B</b><br><br>x 4 | <b>C</b><br><br>x 1 | <b>I</b><br><br>x 1 | <b>J</b><br> M8<br>x 65<br>x 4 | <b>K</b><br><br>x 4 |
|--------------------------------------------------------------------------------------------------------|--------------------------------------------------------------------------------------------------------|--------------------------------------------------------------------------------------------------------|---------------------------------------------------------------------------------------------------------|---------------------------------------------------------------------------------------------------------------------|----------------------------------------------------------------------------------------------------------|



2

|                                                                                               |                                                                                               |                                                                                               |                                                                                                 |                                                                                                 |
|-----------------------------------------------------------------------------------------------|-----------------------------------------------------------------------------------------------|-----------------------------------------------------------------------------------------------|-------------------------------------------------------------------------------------------------|-------------------------------------------------------------------------------------------------|
| D<br><br>x 1 | E<br><br>x 1 | F<br><br>x 3 | G<br><br>x 2 | H<br><br>x 1 |
|-----------------------------------------------------------------------------------------------|-----------------------------------------------------------------------------------------------|-----------------------------------------------------------------------------------------------|-------------------------------------------------------------------------------------------------|-------------------------------------------------------------------------------------------------|

