

## Ambra 120N

### Features

- Complete Vanity Unit
- Available in 7 Finishes: Glossy White, Nordic Oak, Anthracite, Samara Ash, Matte White, Matte Sand, and Royal Blue
- Wall-hung design offers a clean, streamlined look
- Four soft close drawers with organizer in upper drawers
- Includes integrated sink and vanity top in gloss white ceramic with faucet hole and overflow
- Fully assembled with structure and front made of engineered wood in wood finishes and high gloss lacquered
- Handle integrated in front of furniture
- Hidden hanging bracket directly assembled with great resistance and depth regulations
- Made in Spain









### Related Items:

- WSBC 53991 | Push Waste Drain
- WSBC 53922 | Decorative Trap

### SKU# | Options:

- Ambra 120N NO | Nordic Oak
- Ambra 120N SA | Samara Ash
- Ambra 120N WG | Glossy White
- Ambra 120N AN | Anthracite
- Ambra 120N WM | Matte White
- Ambra 120N SM | Matte Sand
- Ambra 120N RB | Royal Blue

### Finishes:

-  Nordic Oak
-  Samara Ash
-  Glossy White
-  Anthracite
-  Matte White
-  Matte Sand
-  Royal Blue

### Codes & Standards:

- CARB2 Compliant and Certified
- TSCA Compliant and Certified

\* WS Bath Collections reserves the right to revise dimensions or information on this sheet without notice

<b>Collection  </b> Ambra	<b>Model  </b> Ambra 120N	Dimensions Metric <i>1 inch = 2.54 cm</i> <i>1 inch = 25.4 mm</i>	 1051 Lea Drive - Collegeville, PA 19426 Tel. 215 513 9400 - Fax 610 831 0215 <a href="http://www.ws bathcollections.com">www.ws bathcollections.com</a> - <a href="mailto:info@ws bathcollections.com">info@ws bathcollections.com</a>
------------------------------	------------------------------	---	---

*Technical features*

Technical drawing	Name	Material	Colour	Colour
	SLIM			Gloss White

	<b>AMBRA</b> 4 Drawers 			Nordic Oak
				Samara Ash
				Gloss White
				Anthracite
				Matte Sand
				Matte White
				Royal Blue

*Technical information*

STRUCTURE	MDF board in 58 in. continuous wrapping in 2D/ Cyclum Process.
FRONT	MDF board in 58 in. continuous wrapping in 2D/ Cyclum Process.
HANDLE	Integrated in the front of the furniture.
DRAWER	Drawers made in mokka textile polyamine coated board with hidden partial extraction runners with soft close system. Includes organizer in upper drawer. Lower drawer useful space (widthxhighxdepth): 20 <sup>1/16</sup> x 4 <sup>5/16</sup> x 12 <sup>2/4</sup> in.
WALL HANGING BRACKET	Hidden hanging bracket of directly assembled with great resistance and depth regulations.
HINGE	105° opening, 1 <sup>3/8</sup> in. cap, easy assembly and soft close system.
LEGS	Metallic in bright chrome finish. (optional)
PIPE DEPTH	Pipe depth 2 <sup>1/54</sup> in.

Collection  
Ambra

Model |  
Ambra 120N

Dimensions Metric  
1 inch = 2.54 cm  
1 inch = 25.4 mm



1051 Lea Drive - Collegeville, PA 19426  
Tel. 215 513 9400 - Fax 610 831 0215  
[www.ws bathcollections.com](http://www.ws bathcollections.com) - [info@ws bathcollections.com](mailto:info@ws bathcollections.com)

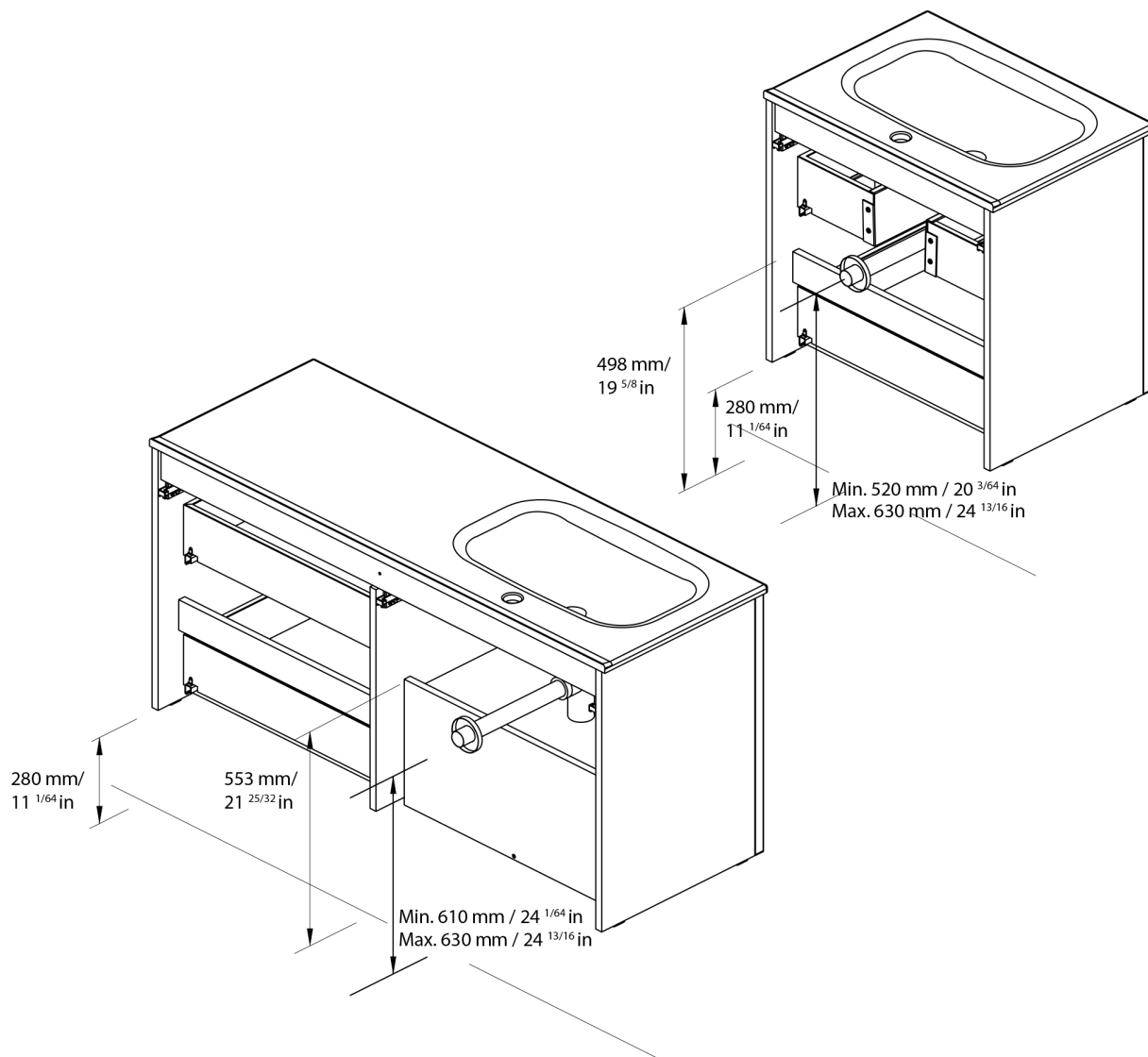

ES

EN

Las cotas indicadas en los dibujos son en función de la altura de la pata del conjunto, en caso de que el mueble vaya suspendido y esta altura no se respete, dichas cotas también variarán.

Dimensions indicated in the drawing are based on the level of the whole leg, in case of wall hanging the furniture dimensions also may vary.

Collection  
Ambra

Model |  
Ambra 120N

Dimensions Metric

1 inch = 2.54 cm  
1 inch = 25.4 mm

WS<sup>®</sup>

BATH  
COLLECTIONS

1051 Lea Drive - Collegeville, PA 19426

Tel. 215 513 9400 - Fax 610 831 0215

[www.ws bathcollections.com](http://www.ws bathcollections.com) - [info@ws bathcollections.com](mailto:info@ws bathcollections.com)

We recommend the following items that work with your sink.

Ambra 120N

## TRAPS



WSBC 53922  
*Our best seller*

Polished Chrome  
WSBC 53922.29

Matte Black  
WSBC 53922.22



WSBC 5392

Polished Chrome  
WSBC 5392.29



WSBC 53925

Polished Chrome  
WSBC 53925.29



WSBC 53921  
*Space saving*

Polished Chrome  
WSBC 53921.29

Matte Black  
WSBC 53921.22

## DRAINS



WSBC 53991  
Push waste drain (click clack)  
*with overflow*

Polished Chrome  
WSBC 53991.29

Glossy White  
WSBC 53991.09

Glossy Black  
WSBC 53991.18

Matte White  
WSBC 53991.26

Matte Black  
WSBC 53991.22

## MOUNTING HARDWARE

### Wall-mount installation

### Vessel/ countertop installation



Bolts



Silicone (optional)

Collection  
Ambra

Model |  
Ambra 120N

Dimensions Metric  
*1 inch = 2.54 cm*  
*1 inch = 25.4 mm*

WS<sup>®</sup>  
BATH  
COLLECTIONS

1051 Lea Drive - Collegeville, PA 19426  
Tel. 215 513 9400 - Fax 610 831 0215  
[www.ws bathcollections.com](http://www.ws bathcollections.com) - [info@ws bathcollections.com](mailto:info@ws bathcollections.com)