

Assembly Instructions

Caution : You must read this before you proceed.

The Headboard and its Parts are Heavy.

At least two adults are required for lifting and moving them.

This Headboard must be used in conjunction with a Mattress Support Frame (not included and not supplied with this Headboard)



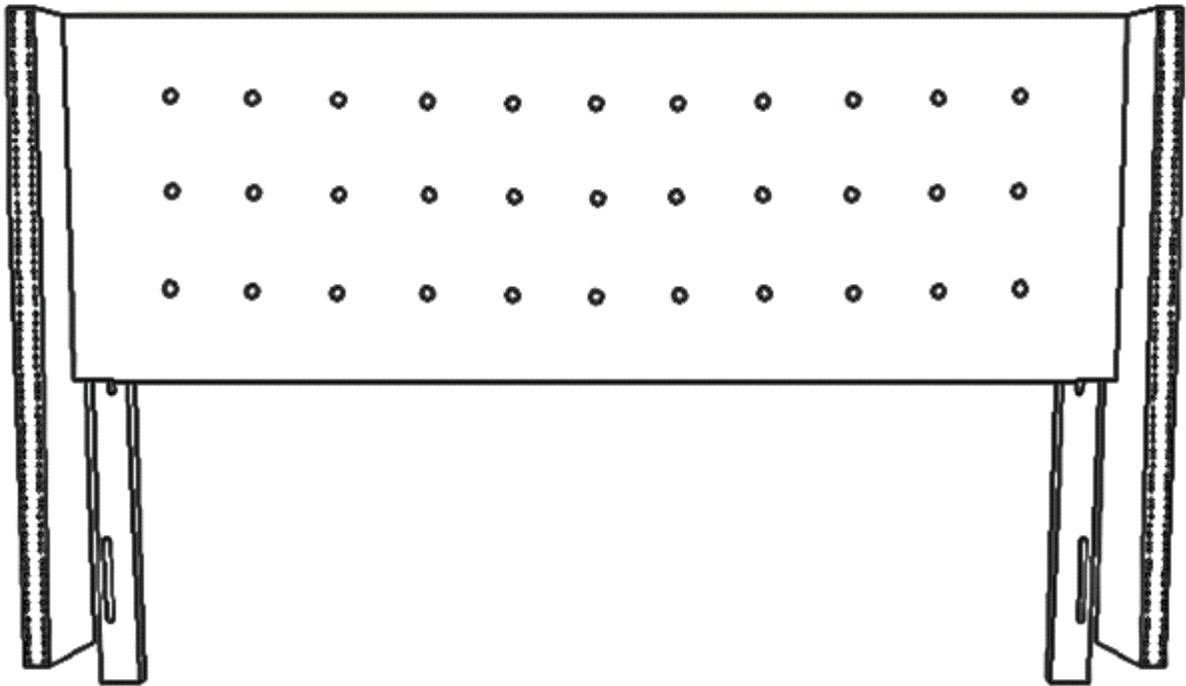



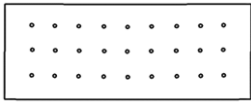
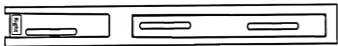
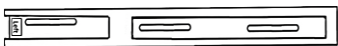
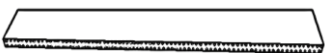
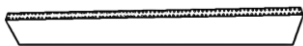





Headboard



Parts List

Part NO.	Picture	Description	Qty
A		Headboard	1
B		Left Support Leg (with 3 Mounting Brackets, marked 'Left' on the bottom)	1
C		Right Support Leg (with 3 Mounting Brackets, marked 'Right' on the bottom)	1
D		Left Wing	1
E		Right Wing	1

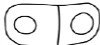
Hardware

Label	Picture	Description	Qty
①		Bolt (M8x45mm)	9
②		Spring Washer	9
③		Washer	9
④		Nut	5
⑤		Allen Key	1
⑥		Wrench	1
⑦		Bolt (M8X40mm)	7
⑧		Washer	7
⑨		Screw (2cm self- tapping)	2
⑩		Screw (5cm self- tapping)	2
⑪		Restraint Strap	4
⑫		Metal Brackets	4
⑬		Screwdriver	not provide

Assembly Preparation

Before Beginning Assembly:

Unpack and place all parts for clear visibility.

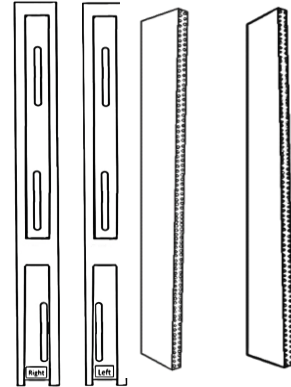
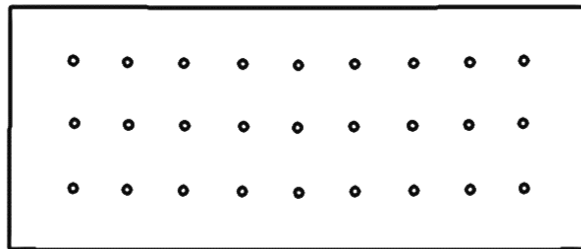

Pack A: For assembling the Legs to the Headboard

Bolts(①)
Washers(③)
Spring Washers(②)
Allen Key(⑤)

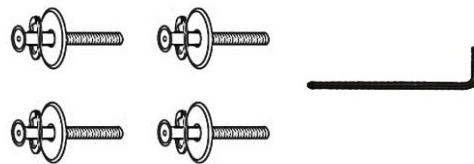

Pack B: For assembling the Legs to the Bed Frame

Bolts(①)
Washer(③)
Spring Washer(②)
Nut(④)
Wrench(⑥)

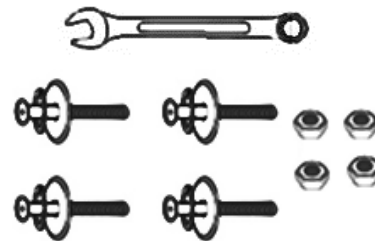

Pack C: For assembling the Wings to the Headboard

Bolts(⑦)
Washer(⑧)
Allen Key(⑤)

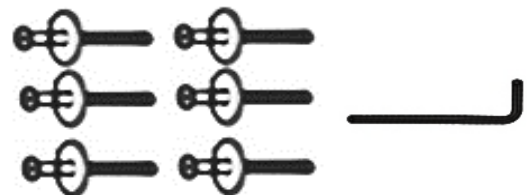

- Read instructions, cover to cover-



- Have 2 adults on hand for assembly-



- Do not assemble on flooring or carpet-



- Assemble on a clean non-marring surface (packing foam)-



- Save all packaging until finished-

Assembly Steps

Overview

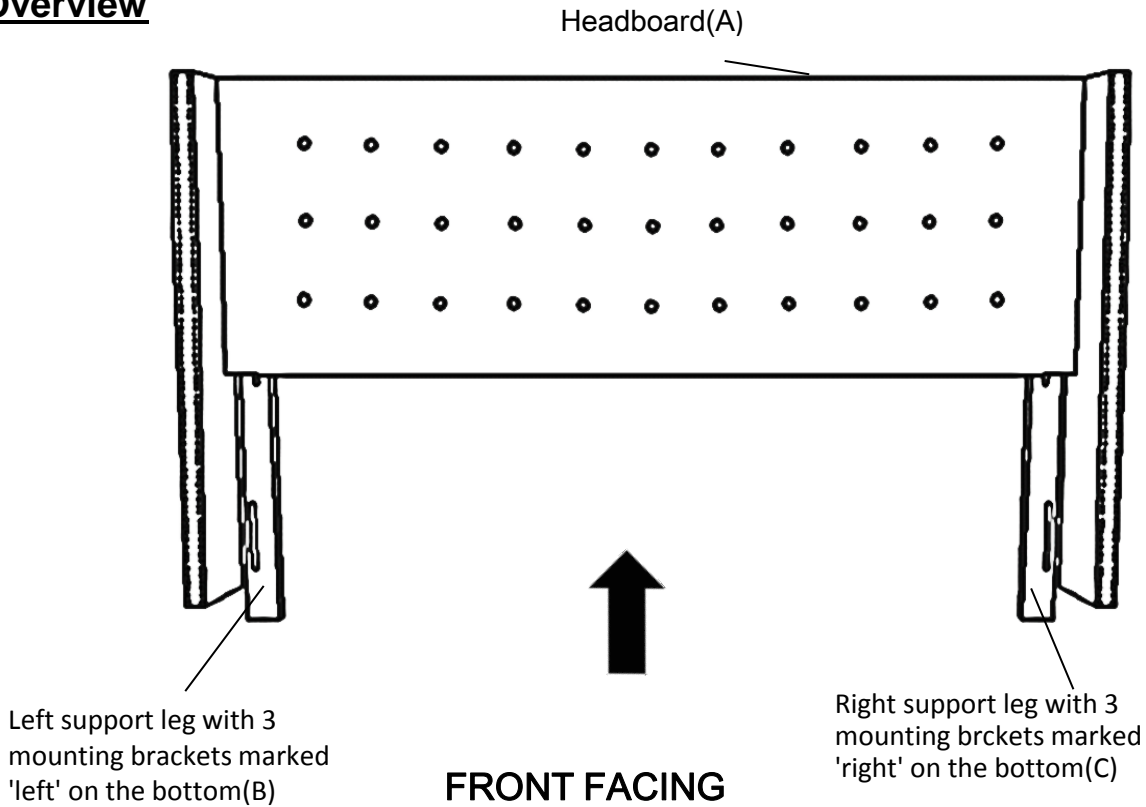

This Headboard has multiple parts and may require up to 30 minutes to assemble. To give you an overview of the Bed parts, the above picture is to help you put the various Bed parts into perspective. Please read through the instructions herebelow to familiarise yourself with the parts and steps before assembly.

Step 2

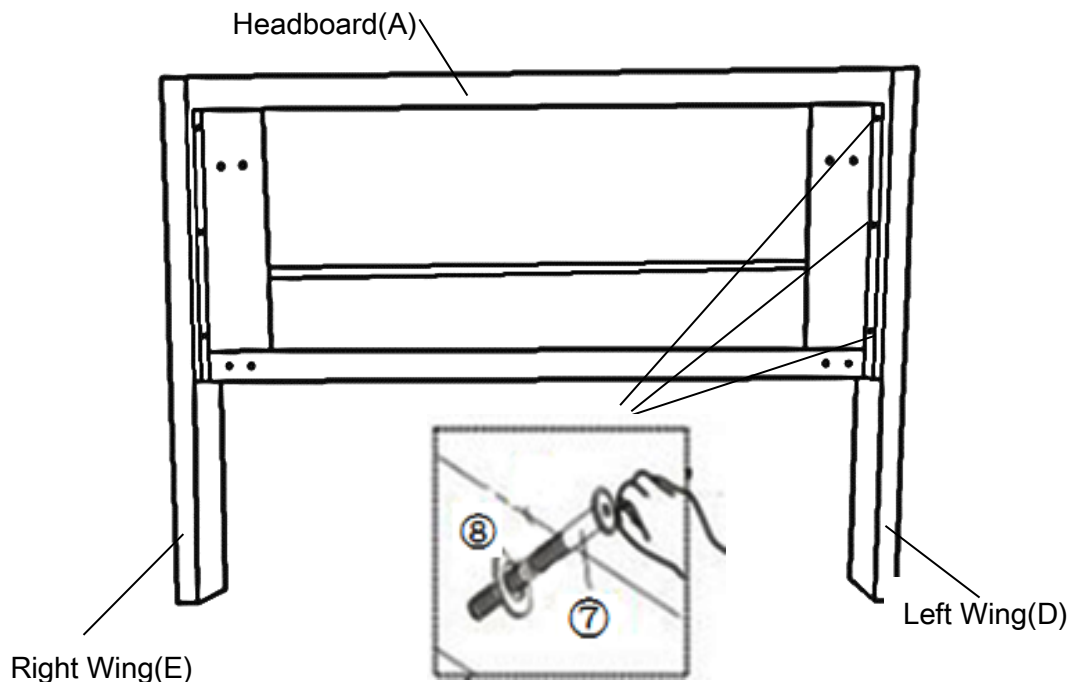

Put the Headboard(A) onto a flat table or panel.
 Align the mounting positions on Headboard(A) to the mounting positions on Left Wing(D).
 Attach Headboard(A) to Left Wing(D) using Bolts(⑦), and Washers(⑧) with Allen Key(⑤).
Tighten Bolts fully in a sequential manner.
 Repeat the same process with the Right Wing(E).

Step 3

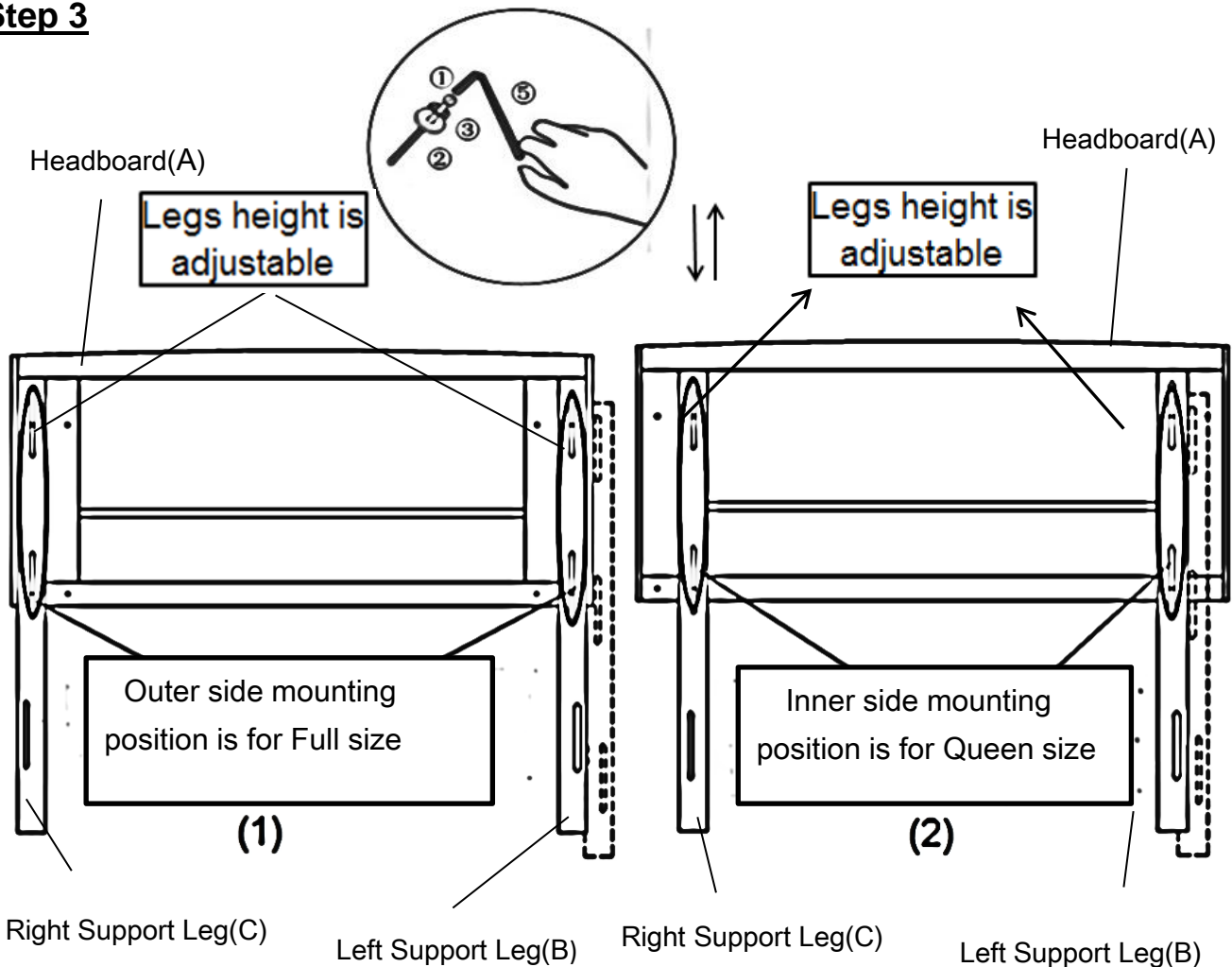

Align the mounting positions on Headboard(A) to those on Left Support Leg(B).
 Attach Headboard(A) to Left Support Leg(B) using Bolts(①), Washers(③) and Spring Washers(②) with Allen Key(⑤).
 Repeat the same process with Right Support Leg(C).
Full Size assembly as shown in Picture(1); Queen as shown in Picture(2)
 At this point of assembly, **do not overtighten the connections.**
The final height of the Headboard may be adjusted to your own need.

Step 4

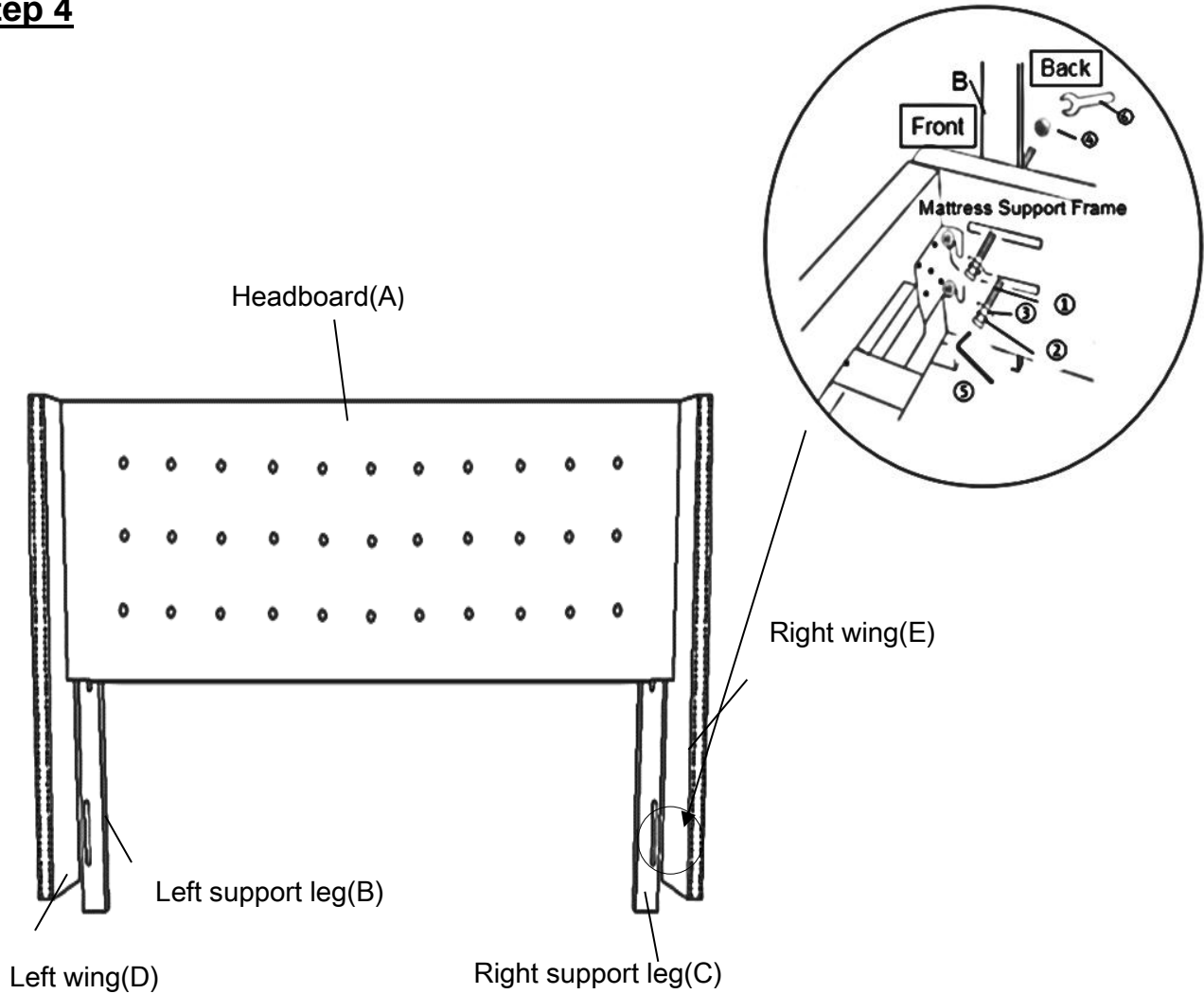

Hold the Headboard upright and align the bottom mounting position to the Mattress Support Frame mounting position.

Attach Headboard to the Mattress Support Frame using Bolts(①), Washers(③), Spring Washers(②) and Nuts(④) with Wrench(⑥).

Please install the Bolts from the FRONT TO BACK of the Headboard.

Step 5

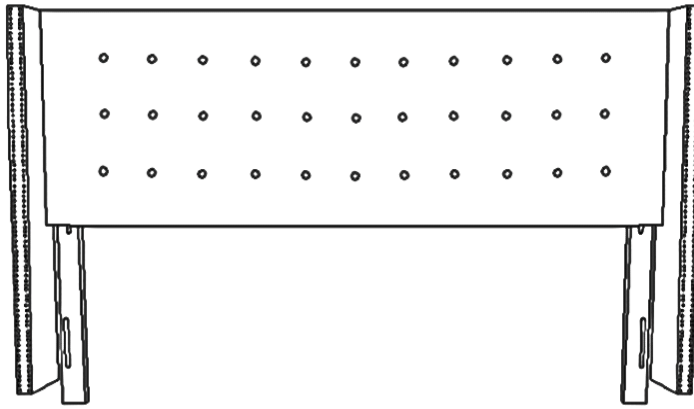

Make sure all parts are connected and securely locked into position.
Your Headboard is ready for use.



WARNING

Serious or fatal crushing injuries can occur from tipping furniture. To help prevent tip-over: ALWAYS secure this furniture to the wall using a Safety Restraint Device. See product instructions for more ways to help prevent furniture tip-over.

Headboard Restraint Device Installation Instruction

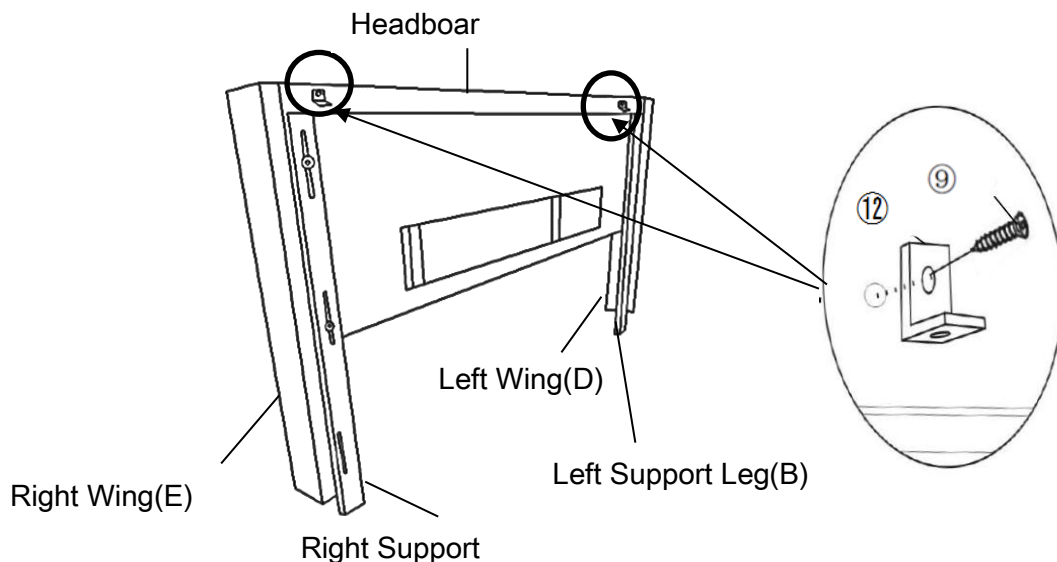

Firstly, turn back the Headboard.

Find the two marks on the product. Then, Attach Metal Brackets(12) to the back of Headboard(A) using Screws(9) with Screwdriver(13) as shown above. Make sure two parts are connected and securely locked into headboard.

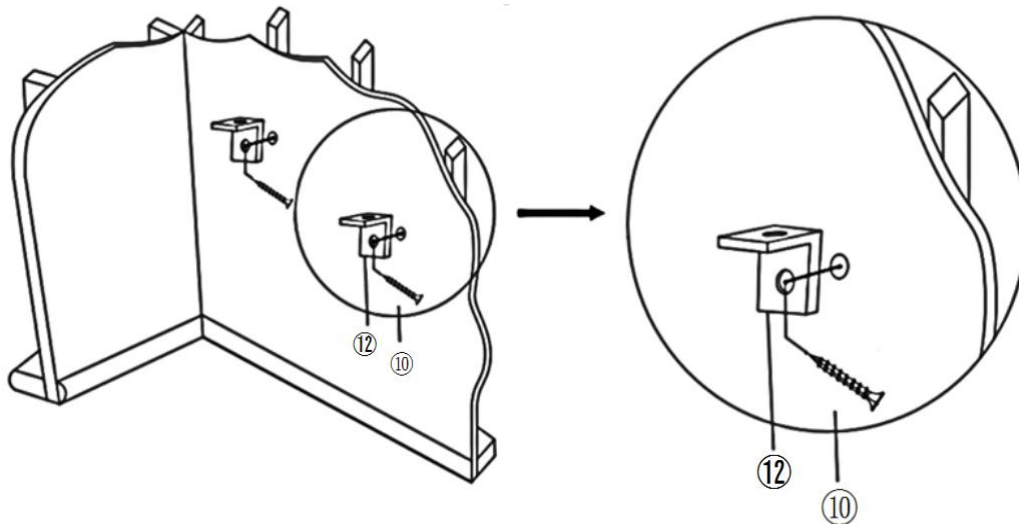

Put the Headboard against the wall where desired and mark the location for the Metal Brackets(12) to be the same height as the top of the Headboard.

Attach Metal Bracket(12) to the wall where you marked using Screws(10) with Screwdriver(13).

Repeat this process with the other Metal Bracket(12).

Note: The Metal Brackets need to be secured to solid, load bearing surface. Please use a Stud Finder(not supplied) if needed to locate the Wall Frame.

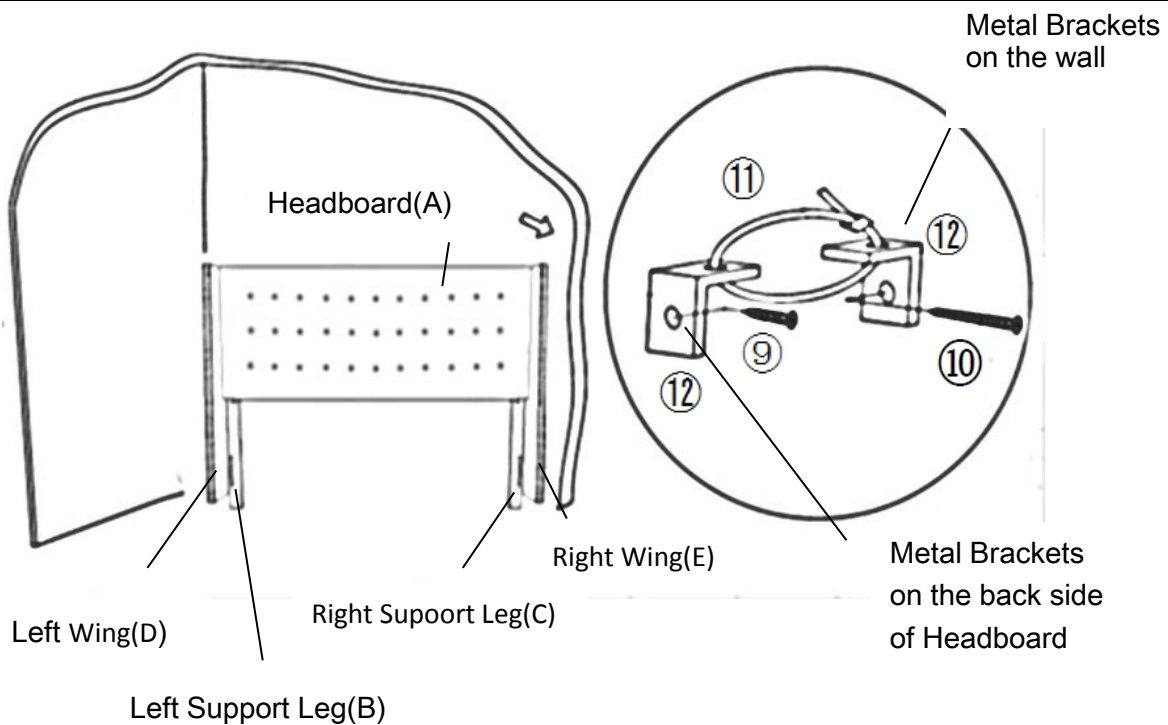

Move the Headboard back against wall.





















Pull the Restraint Straps(11) through the Metal Brackets(12) on the wall and Headboard(A) one by one, and pull the Restraint Straps(11) tight.

Note: 2pcs of Cabinet Restraint Strap(11) on each position.

Headboard Restraint Device is installed and Headboard is ready for use.

The strap between headboard(A) and Metal Brackets(11) on wall should be within 3.5".

Care & Maintenance

-   ● Do not put hot items directly on furniture surface
 -   ● Do not clean furniture with harsh cleansers or polish.
 -   ● Do not place furniture under direct sunlight.
 -   ● Do not place furniture near heating or cooling vents.
 -   ● Do not write on furniture without a padded barrier to protect the surface.
 -   ● Do not place furniture outside . For indoor use only .
 -   ● Not for commercial use. For residential use only .
 -   ● Stains may be removed with mild soap solution and damp cloth.
 -   ● Children should not climb or jump on the furniture.
-
-   ● Dust and pick-up spills using a clean, non-colored, lint-free cloth .

What is Proposition 65?

Proposition 65 is a California law that requires warning labels on products that may contain one of more than 800-plus chemicals or ingredients that the California Office of Environmental Health Hazard Assessment (OEHHA) has deemed to cause cancer or other reproductive toxicity. Chemicals and elements on this list include wood dust, brass, and other everyday substances, which can be found in very common household items, such as: lamps, tableware, jewelry, crystal glasses, electric cords, beauty products, automobiles, and furniture.

Why Did I Find a Proposition 65 Warning on My Home Goods Product?

We include Proposition 65 warnings on all of our products because there is always a chance that one of the 800-plus common chemicals and ingredients listed under this law could potentially be on our furniture or packing materials. We risk large fines under this law, if we don't include this warning.

Should I worry?

We realize you may be worried finding this warning on our products, but we want to reassure you that the hazardous exposure limits for any of these chemicals have never been found on furniture products that we've shipped to our customers. Additionally, this warning label is very common and can be found on almost every piece of furniture sold in the state of California.

Just How Common Are Proposition 65 Warnings?

Proposition 65 warnings have become so common in California that it is hard to take a trip to a local bank, grocery store, or restaurant without finding at least one warning. In fact, even the Disney Land Resort has a Proposition 65 warning:

