

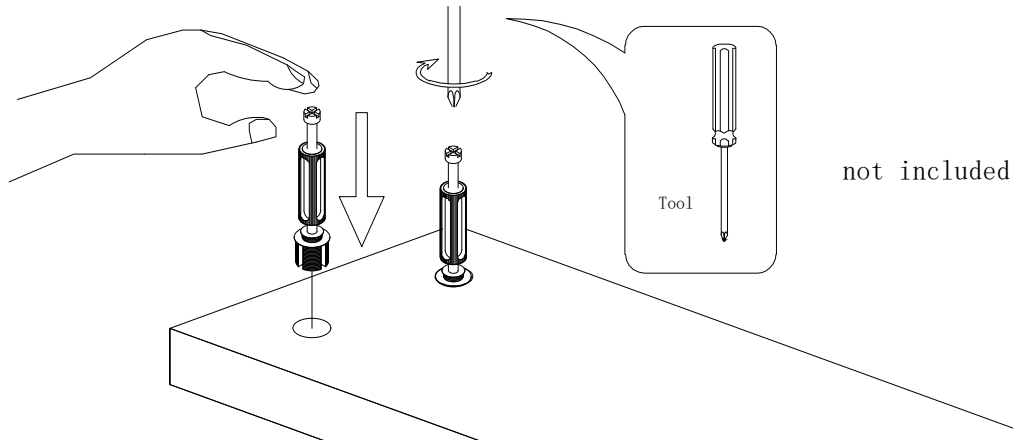

Hardware installation demonstration

NOTE: Please make sure "A" hardware tightened and can't be pulled out!

I





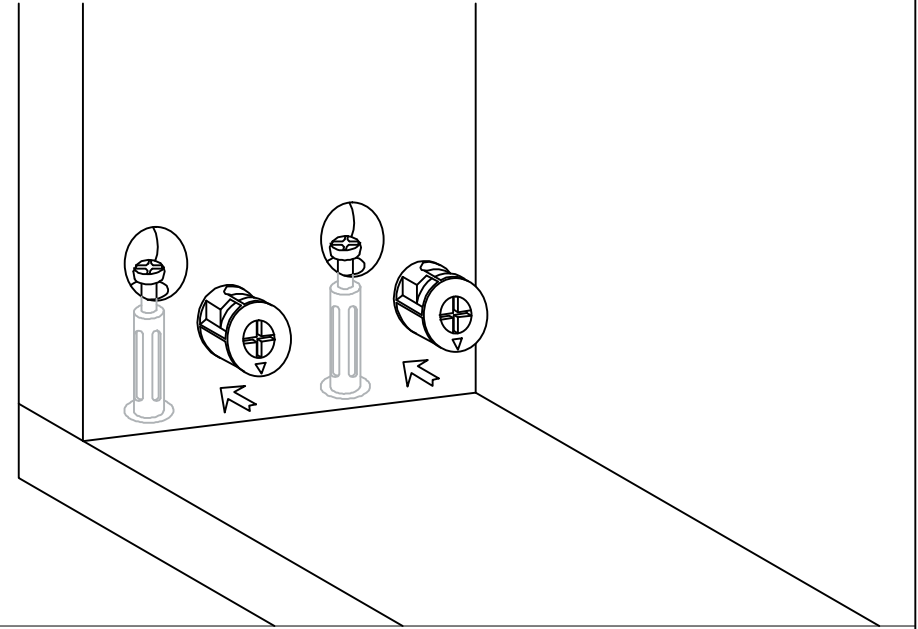



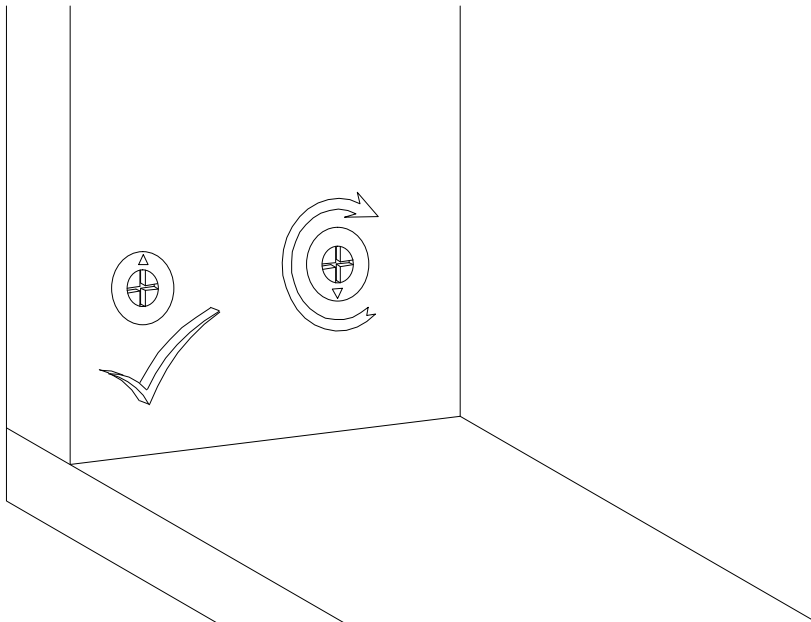

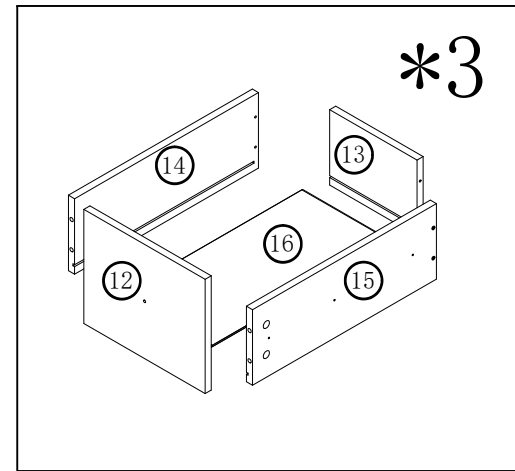
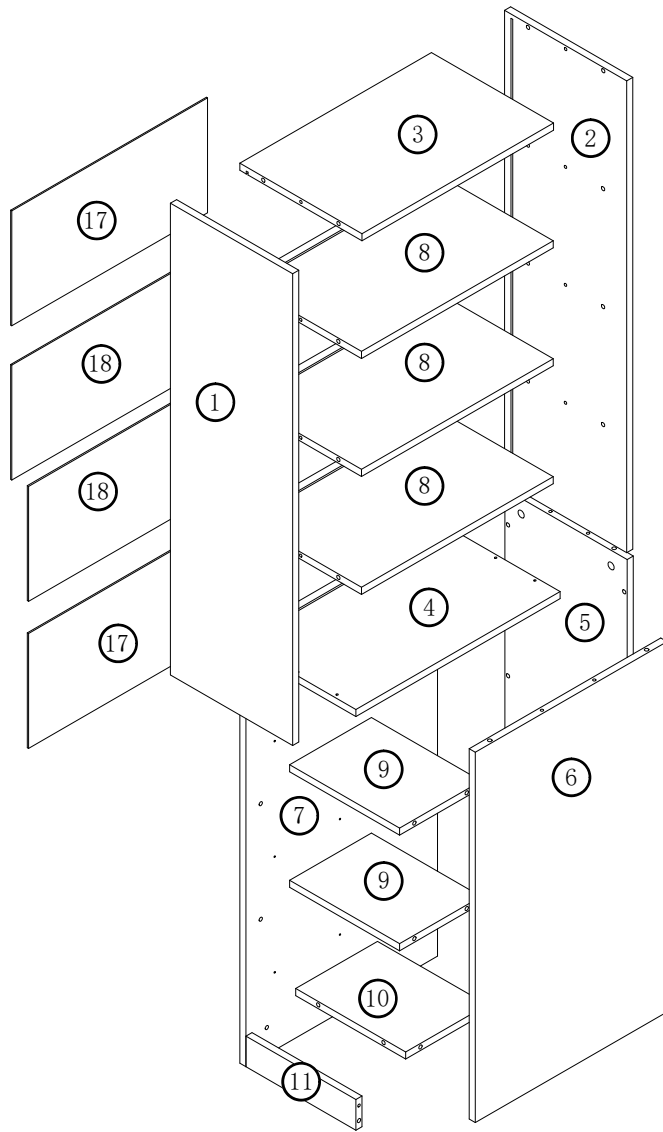

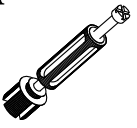

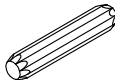
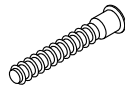
II

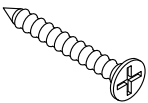

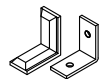
III



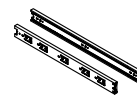

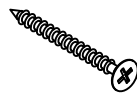
A  56PCS	B  56PCS	C 8*40  20PCS	D 7*50  6PCS	E  3PCS	K 4*50  2PCS	L  6PCS	M  2PCS	N 8*40  2PCS	O  16PCS
					F 4*18  3PCS	G 450mm  3PCS	H 3*12  6PCS	I 3.5*14  38PCS	J 3.5*35  12PCS

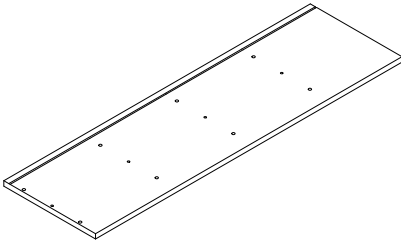
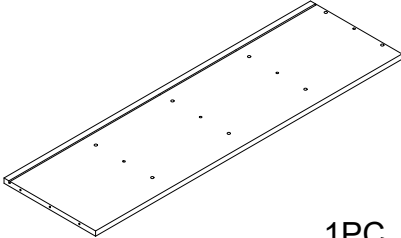
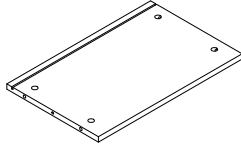
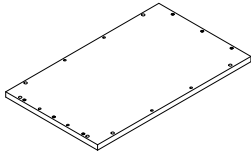
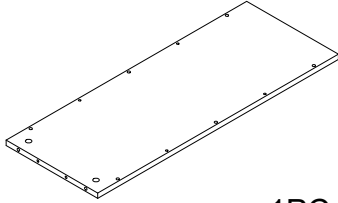
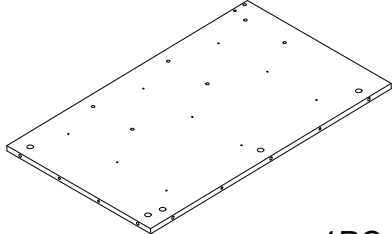
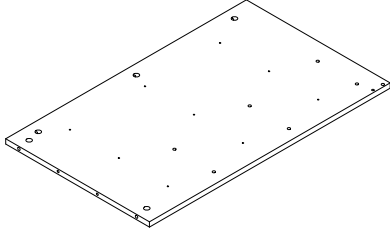
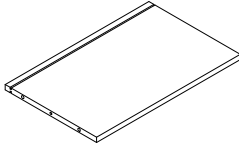
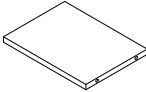
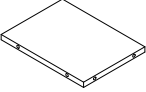
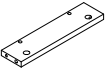
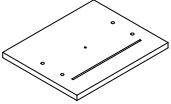
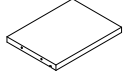
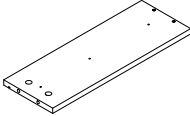
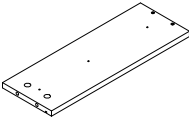
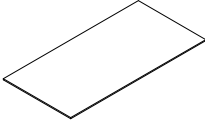
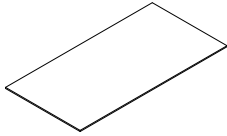
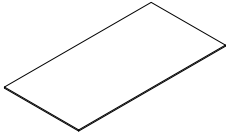
<p>1</p> <p>1000*299 (mm) 39.37*11.77 (inch)</p>  <p>1PC</p>	<p>2</p> <p>1000*299 (mm) 39.37*11.77 (inch)</p>  <p>1PC</p>	<p>3</p> <p>469*299 (mm) 18.46*11.77 (inch)</p>  <p>1PC</p>	<p>4</p> <p>500*300 (mm) 19.69*11.81 (inch)</p>  <p>1PC</p>	<p>5</p> <p>785*299 (mm) 30.91*11.77 (inch)</p>  <p>1PC</p>
<p>6</p> <p>785*469 (mm) 30.91*18.46 (inch)</p>  <p>1PC</p>	<p>7</p> <p>785*469 (mm) 30.91*18.46 (inch)</p>  <p>1PC</p>	<p>8</p> <p>469*298 (mm) 18.46*11.73 (inch)</p>  <p>3PCS</p>	<p>9</p> <p>269*200 (mm) 11.59*7.87 (inch)</p>  <p>2PCS</p>	<p>10</p> <p>269*200 (mm) 11.59*7.87 (inch)</p>  <p>2PCS</p>
<p>11</p> <p>269*65 (mm) 11.59*2.56 (inch)</p>  <p>1PC</p>	<p>12</p> <p>297*242 (mm) 11.69*9.53 (inch)</p>  <p>3PCS</p>	<p>13</p> <p>214*160 (mm) 8.43*6.3 (inch)</p>  <p>3PCS</p>	<p>14</p> <p>450*160 (mm) 17.72*6.3 (inch)</p>  <p>3PCS</p>	<p>15</p> <p>450*160 (mm) 17.72*6.3 (inch)</p>  <p>3PCS</p>
<p>16</p> <p>445*224 (mm) 17.52*8.82 (inch)</p>  <p>3PCS</p>	<p>17</p> <p>479*243.5 (mm) 18.86*9.59 (inch)</p>  <p>2PCS</p>	<p>18</p> <p>479*242 (mm) 18.86*9.53 (inch)</p>  <p>2PCS</p>		<p>20</p>

1

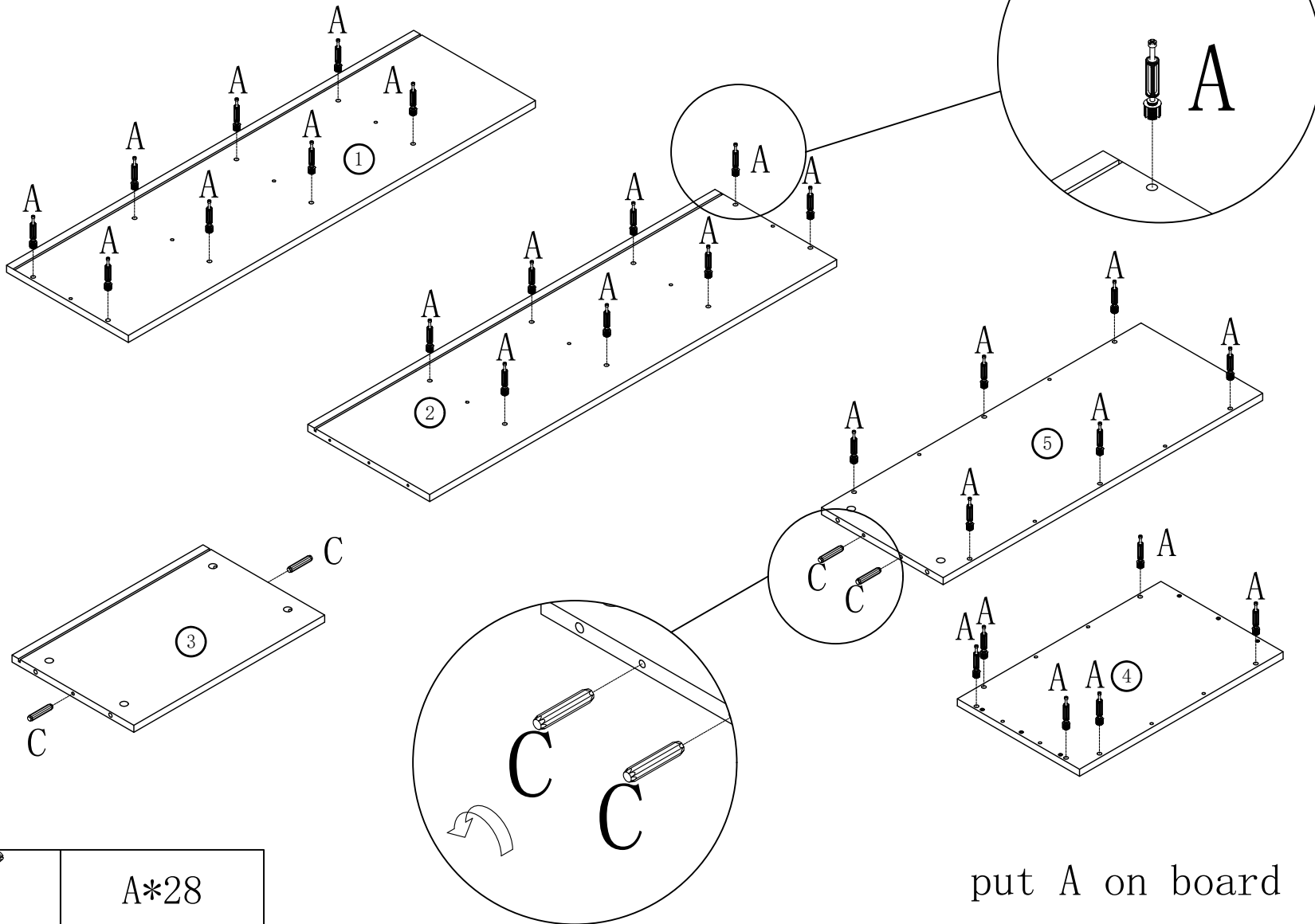

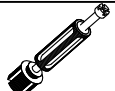
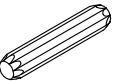
	A*28
	C*4

put A on board (1) (2) (4) (5)
put C on board (3) (5)

2

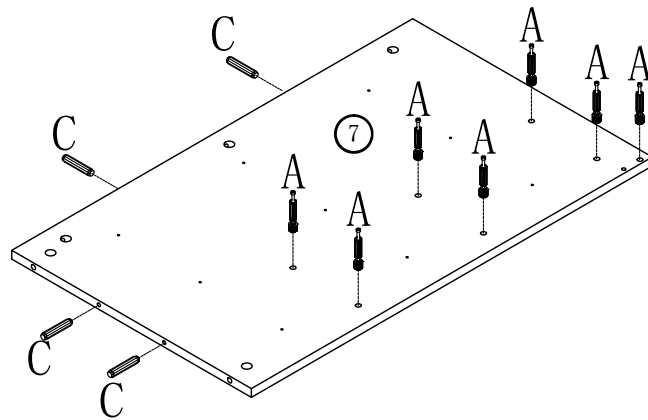
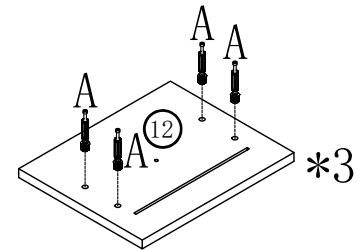
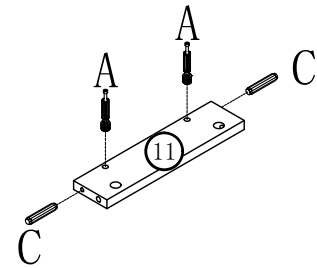
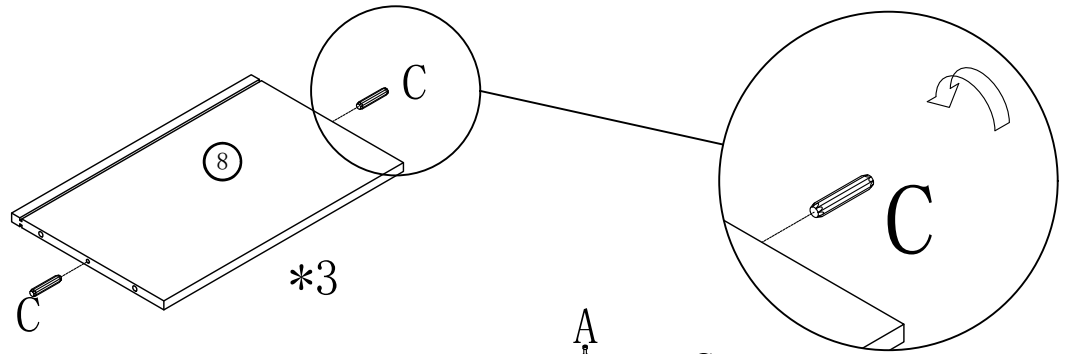
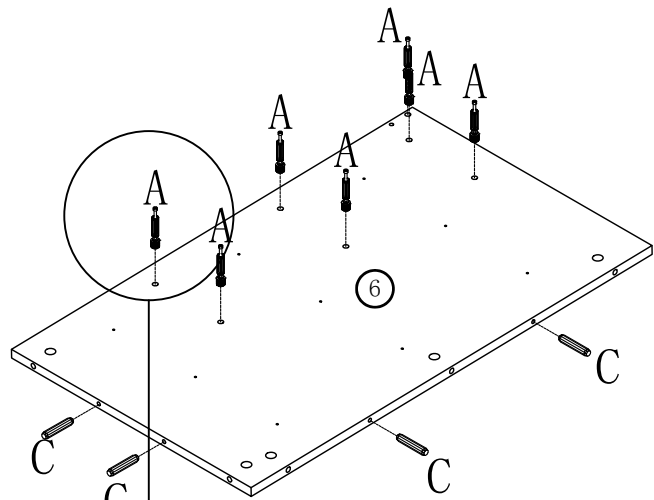

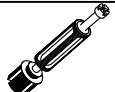
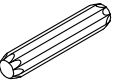

	A*28
	C*16

put A on board ⑥ ⑦ ⑪ ⑫

put C on board ⑥ ⑦ ⑧ ⑭

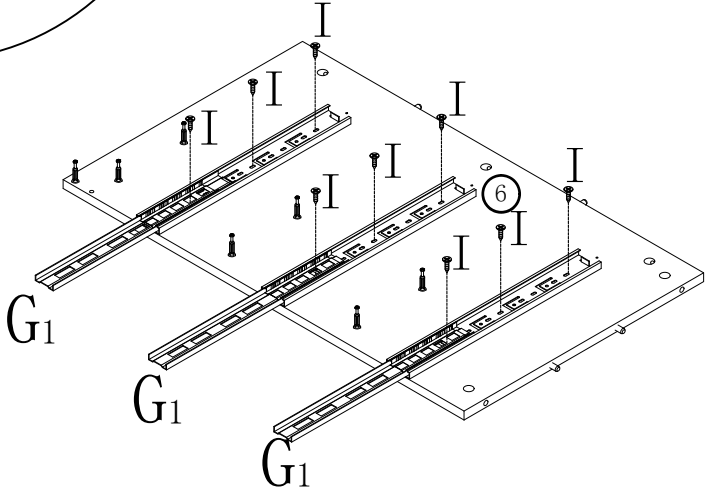
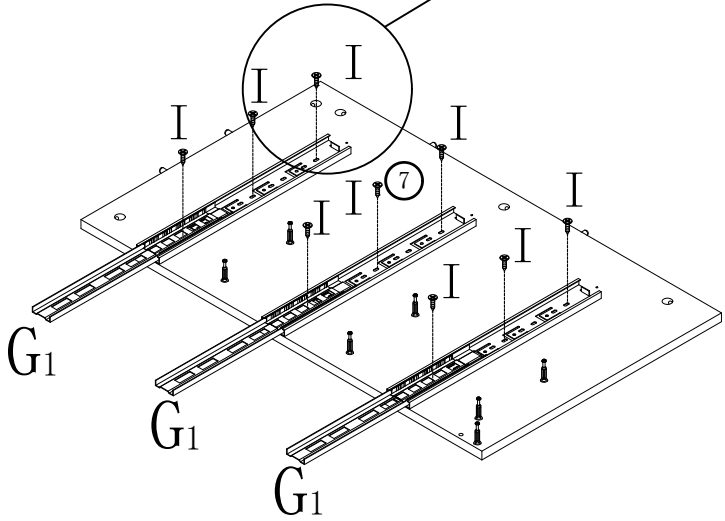
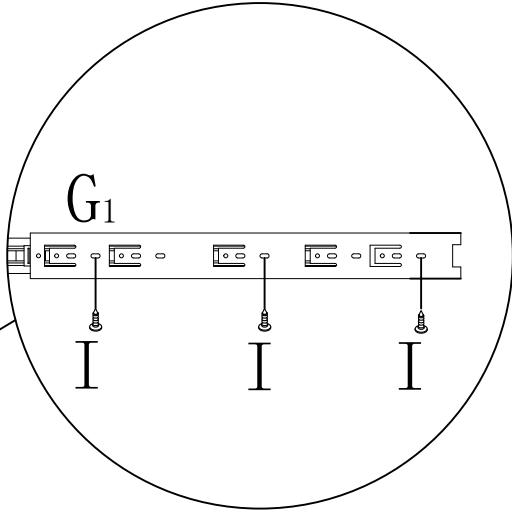
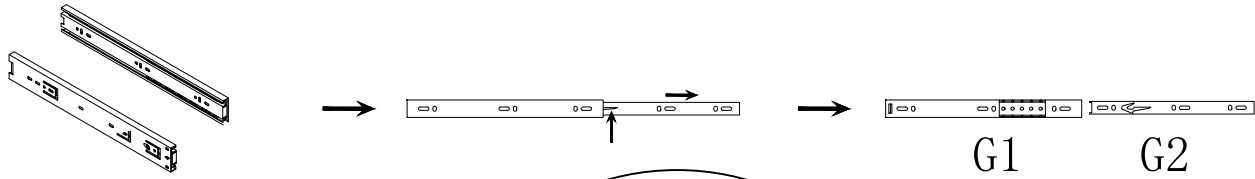
3

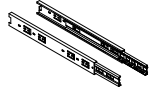

	G1*3
	I*18

4

Make sure the arrow on the screw align to the hole on the side.

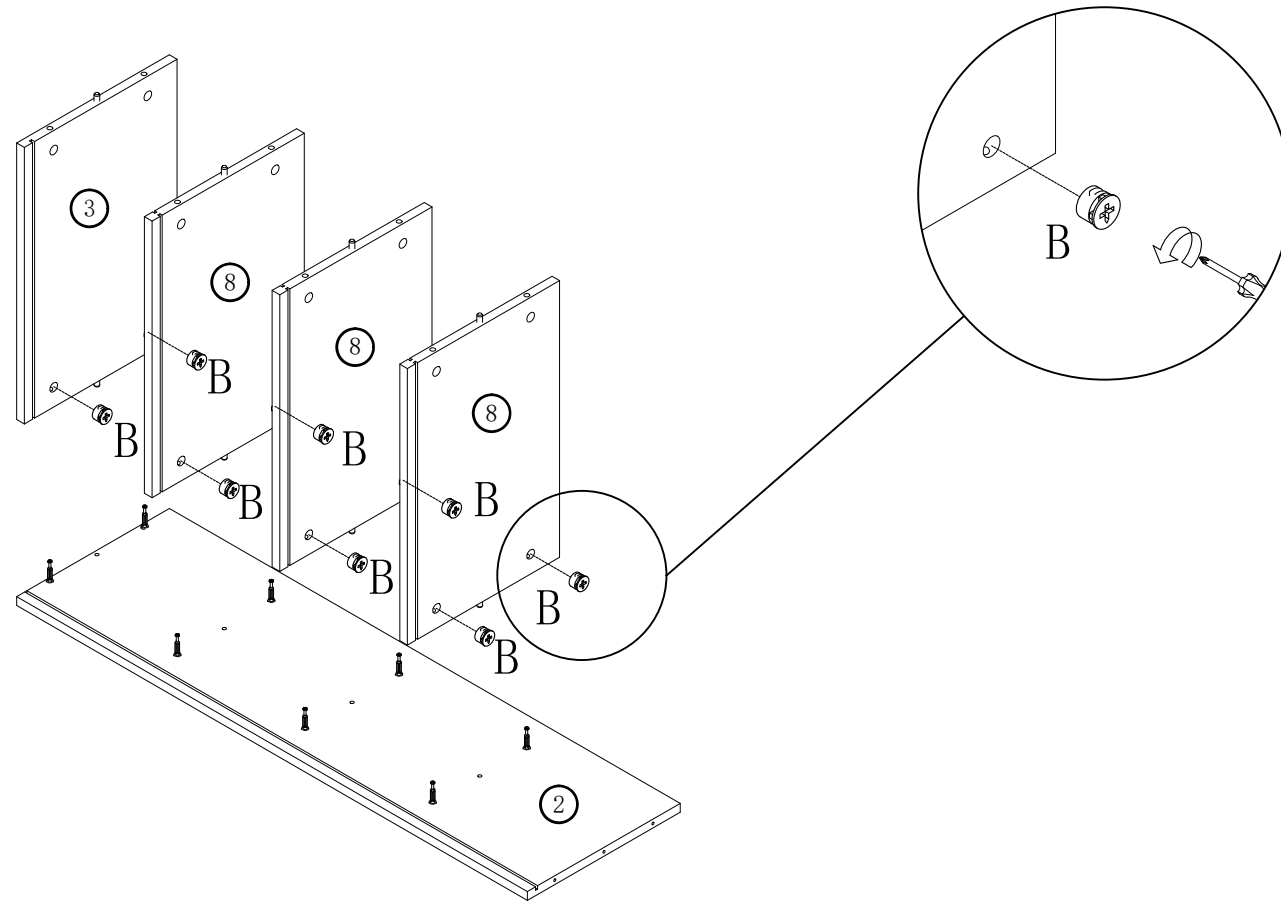

B*8

put B on board 3 8

5

Make sure the arrow on the screw align to the hole on the side.

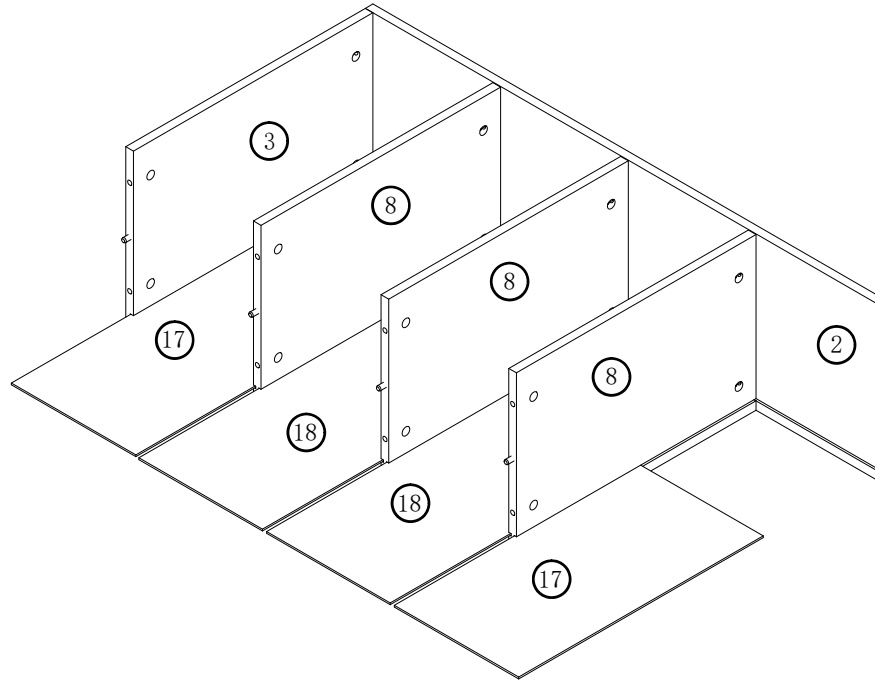

6

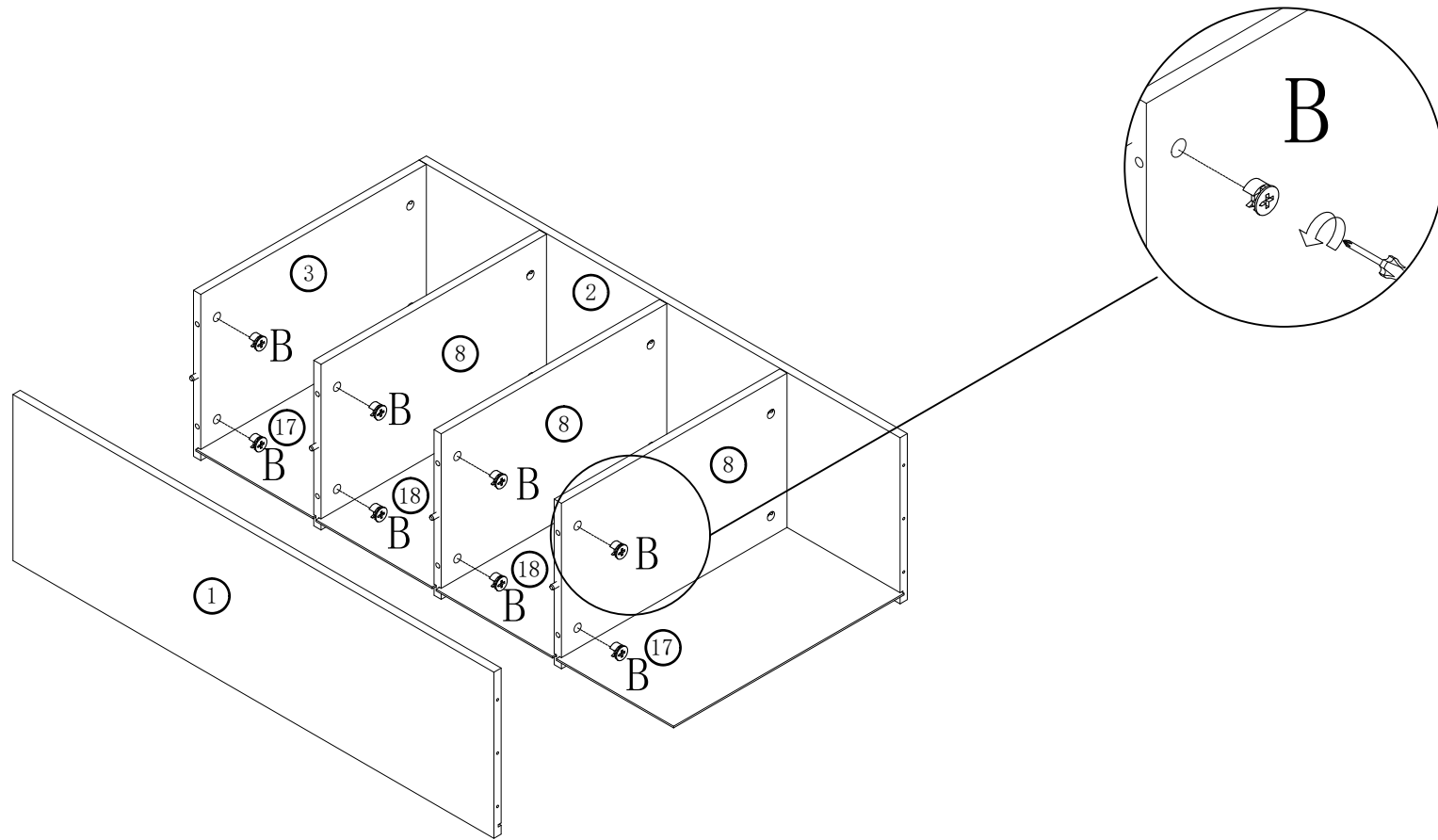

B*8

put B on board ③ ⑧

7

Make sure the arrow on the screw align to the hole on the side.

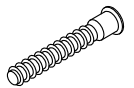
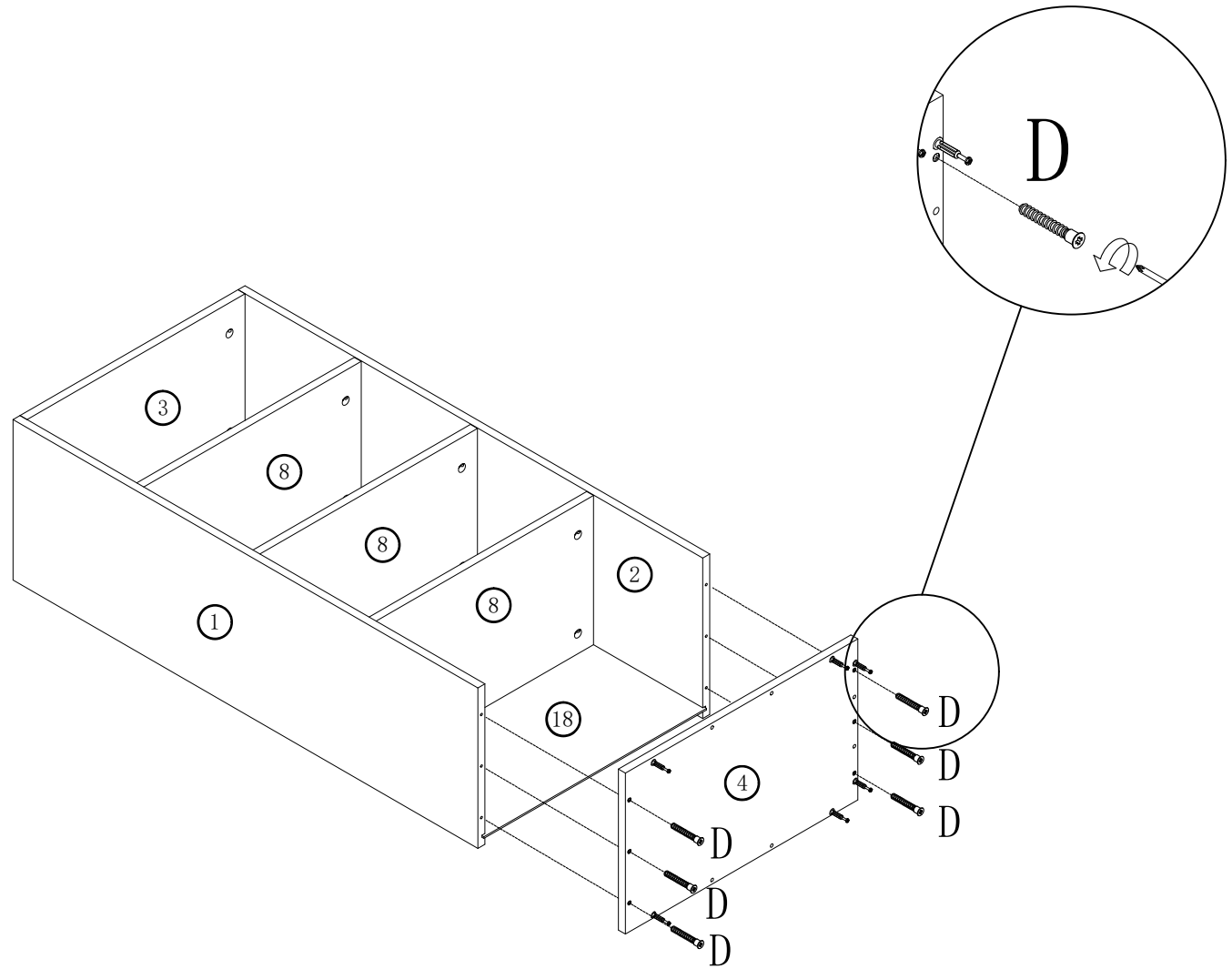

D*6

8

Make sure the arrow on the screw align to the hole on the side.

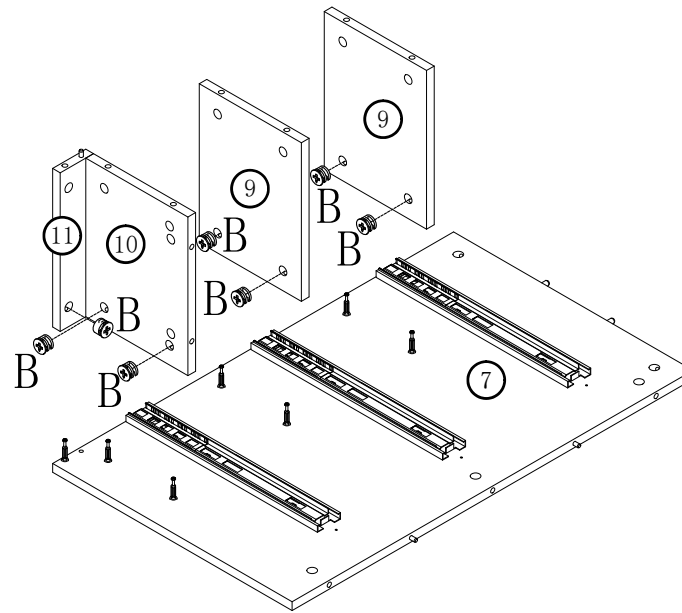
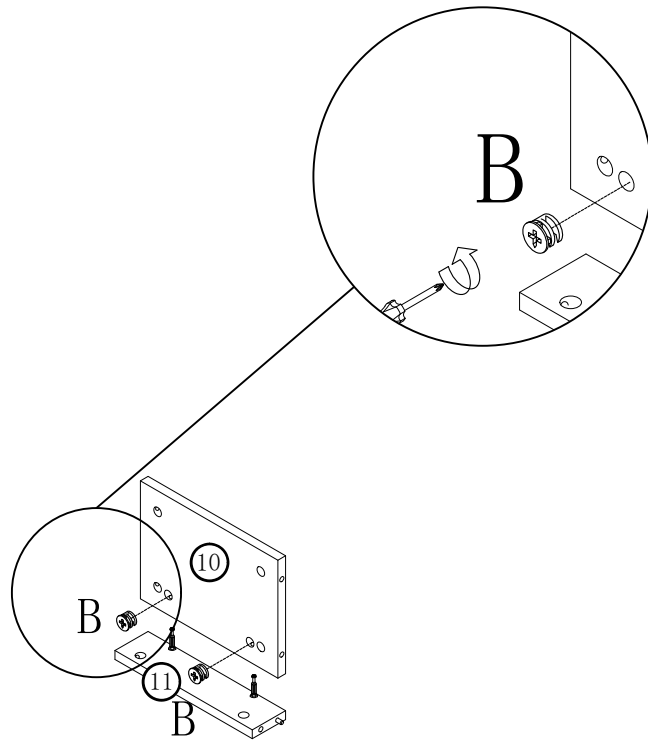

B*9

put B on board ⑨ ⑩ ⑪

9

Make sure the arrow on the screw align to the hole on the side.

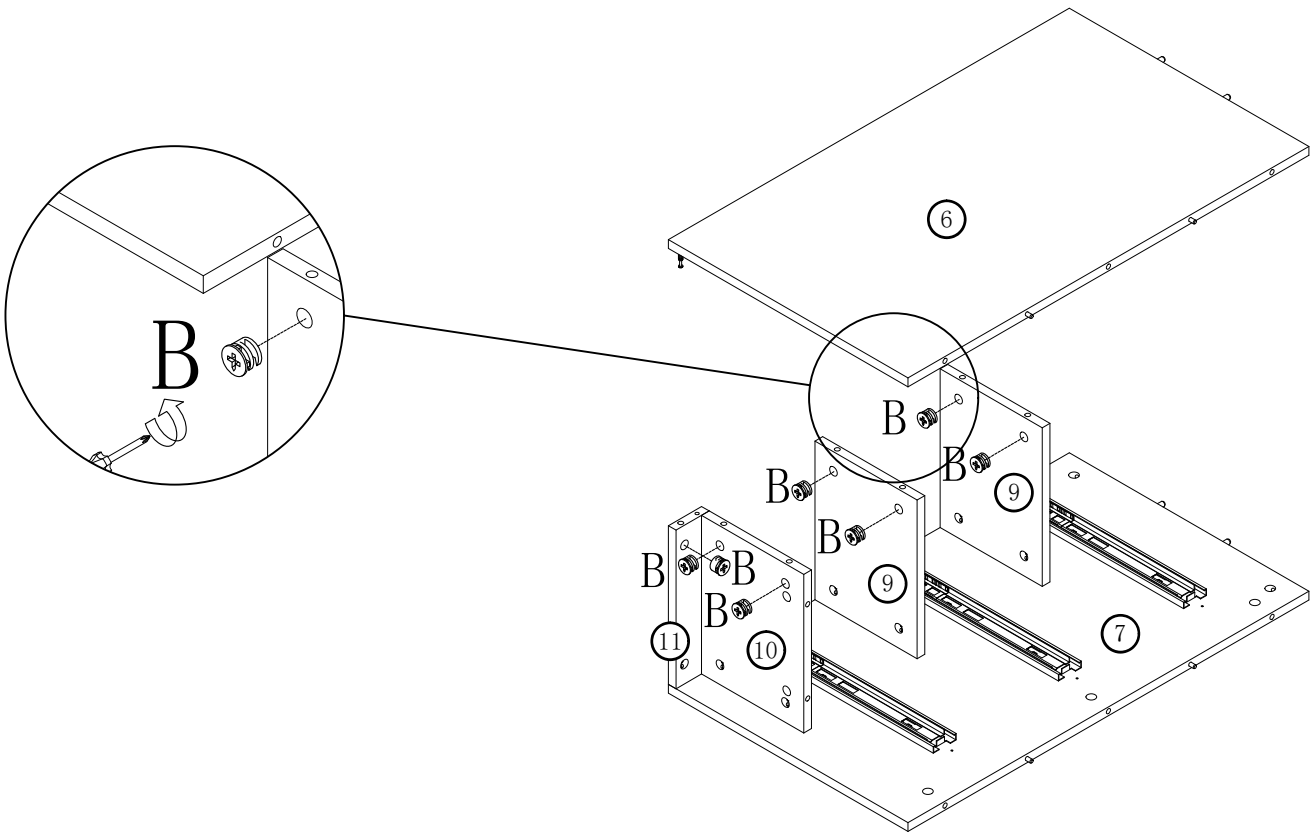

B*7

put B on board 9 10 11

10

Make sure the arrow on the screw align to the hole on the side.

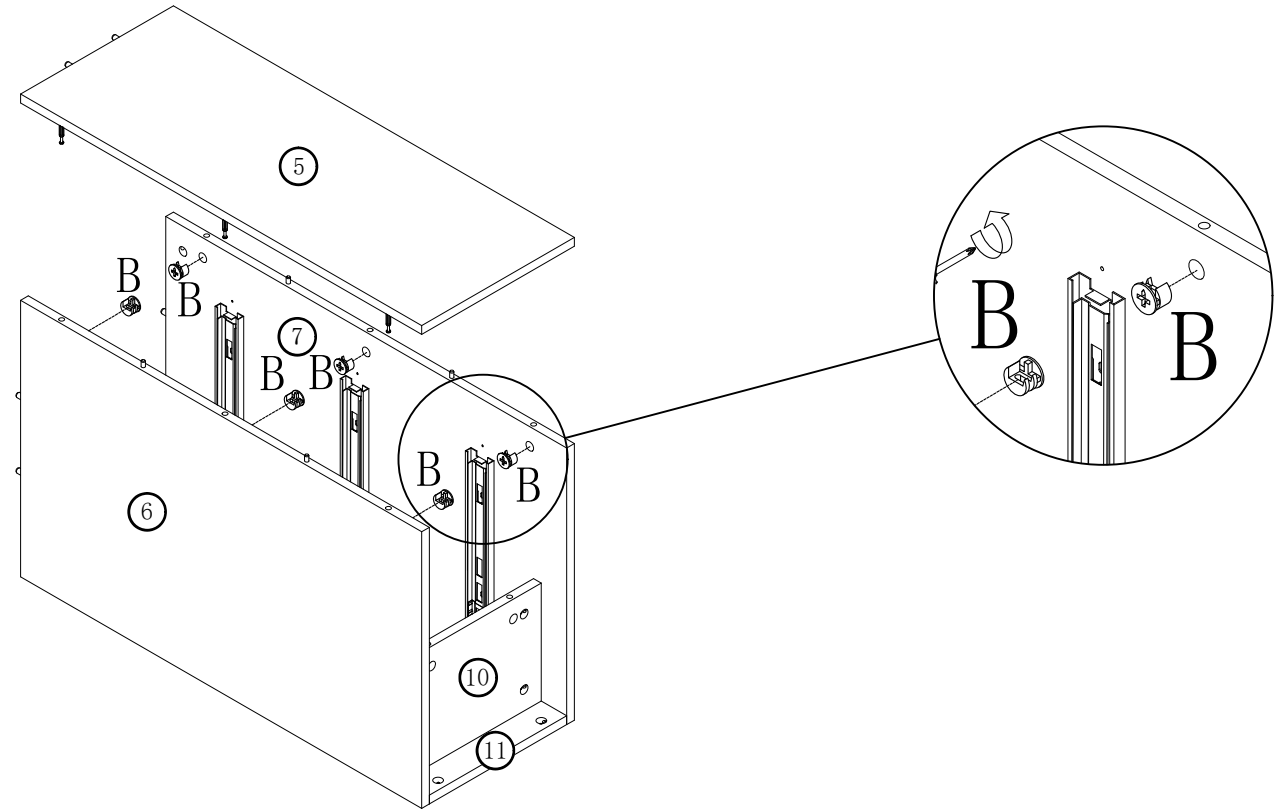

B*6

put B on board ⑥ ⑦

11

Make sure the arrow on the screw align to the hole on the side.

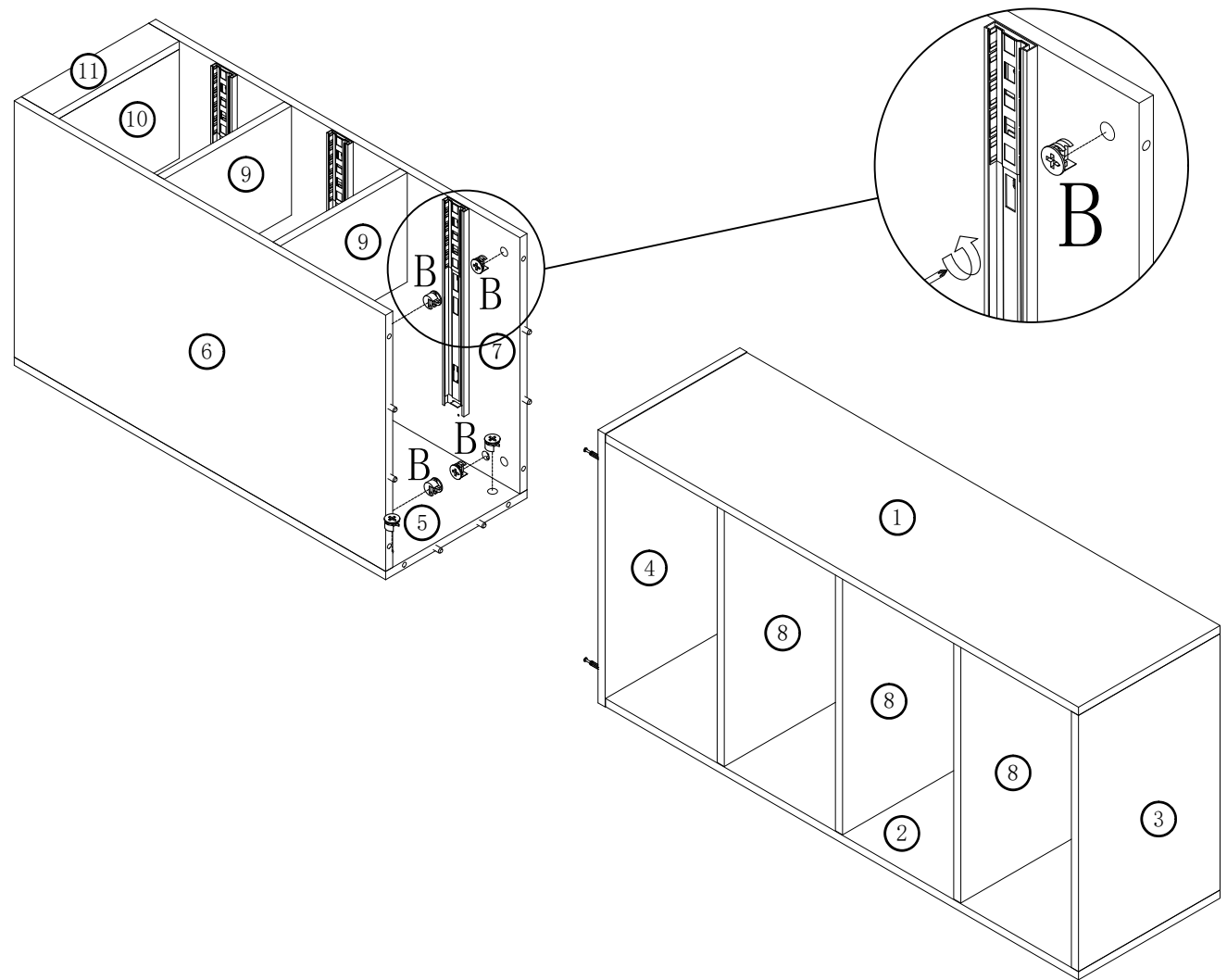

B*6



put B on board 5 6 7

12

Make sure the arrow on the screw align to the hole on the side.

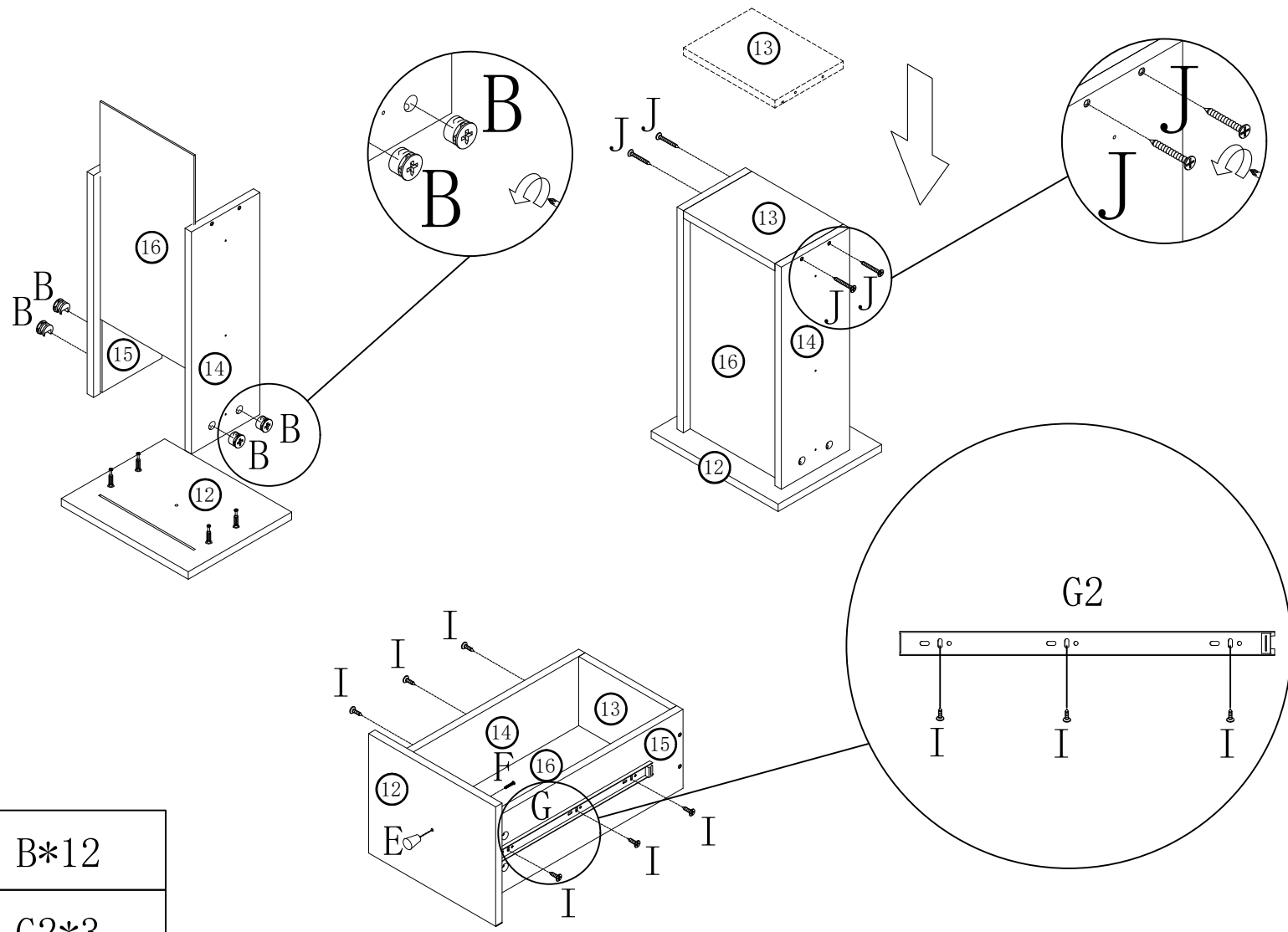
*3

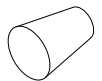
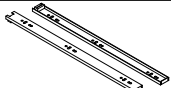

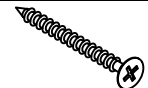
	B*12		E*3
	G2*3		F*3
	I*18		
	J*12		

put B on board 14 15

13

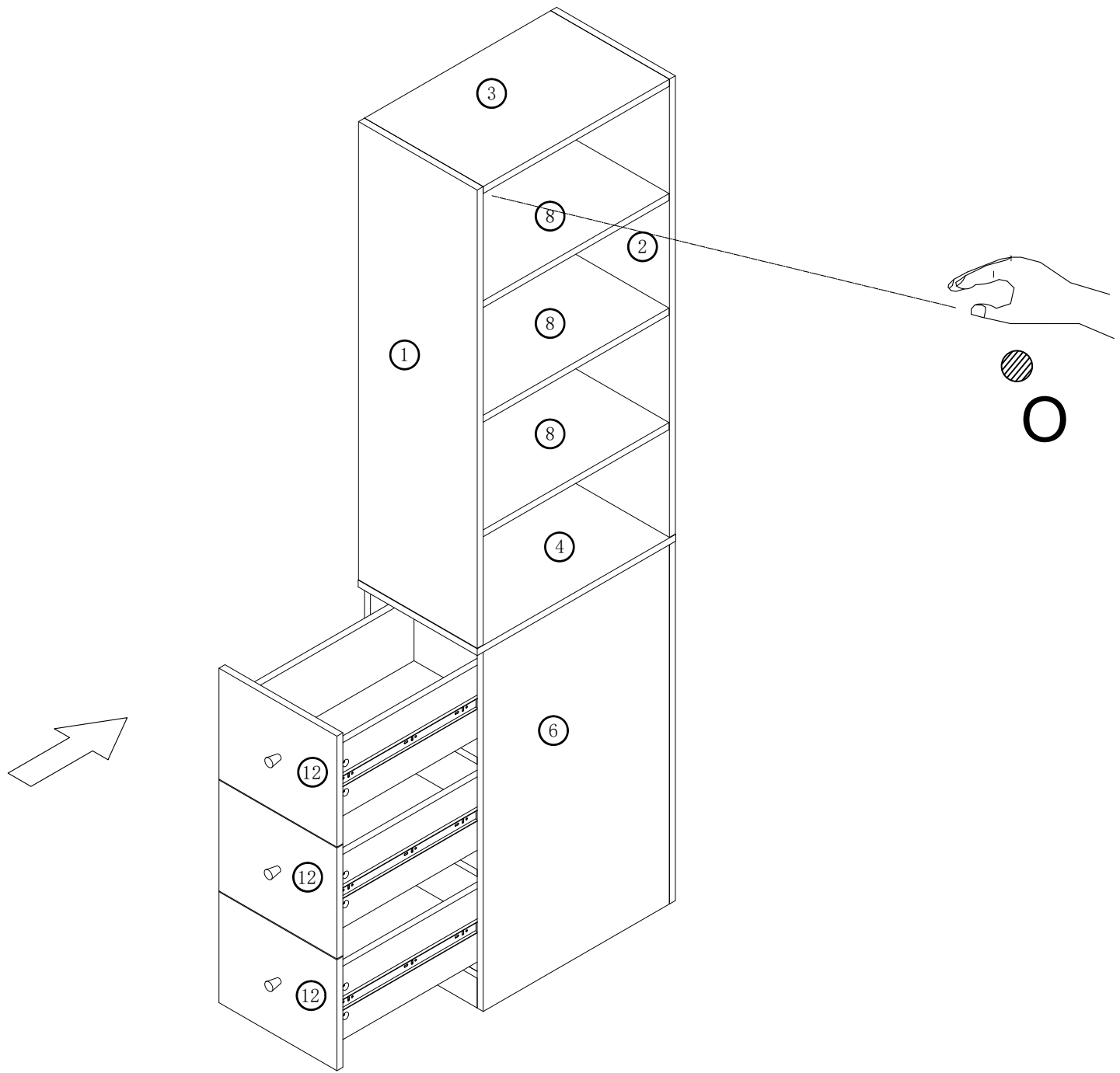

0*16

14

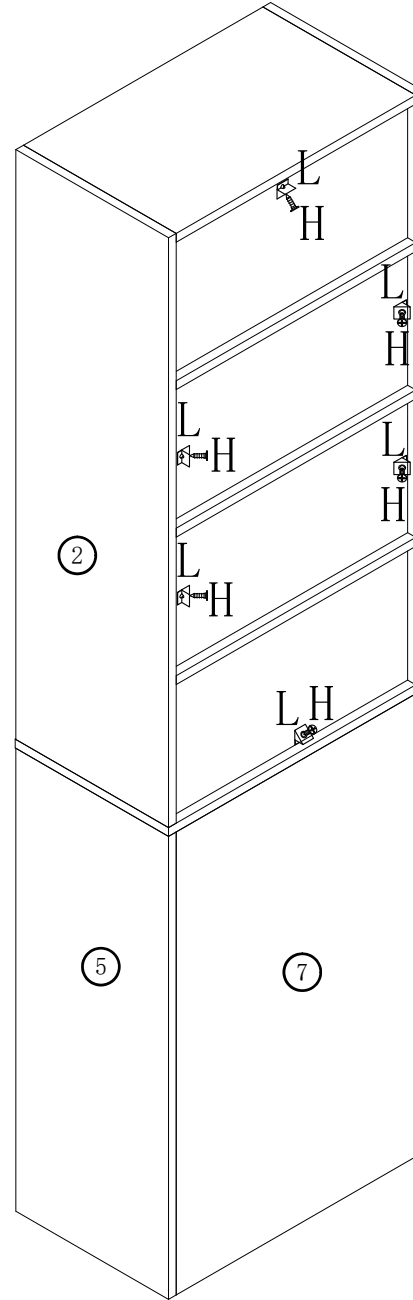





H*6

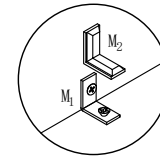
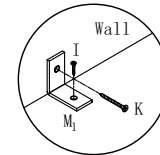
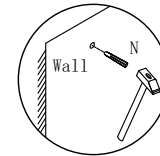
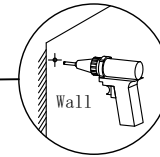
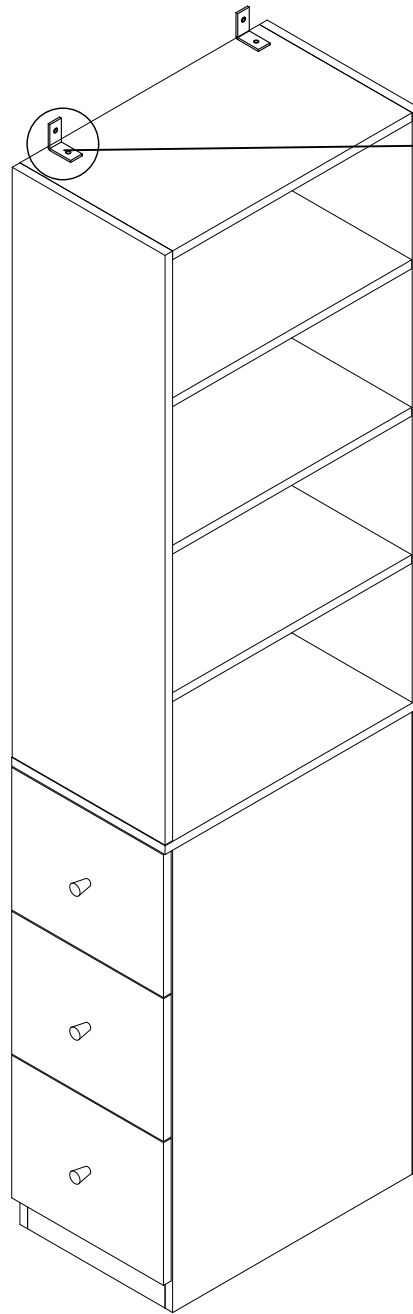

L*6

15

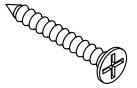

	I*2
	K*2
	M*2
	N*2

16

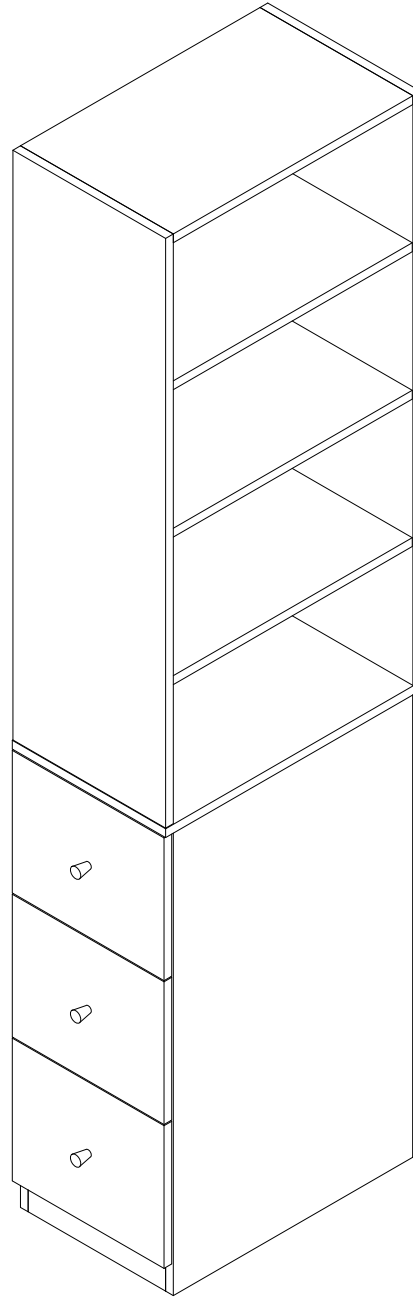

END