

Assembly Instructions

CHAIR

CAUTION: You should read this before proceeding

Please look in the Seat Panel for hardware packs

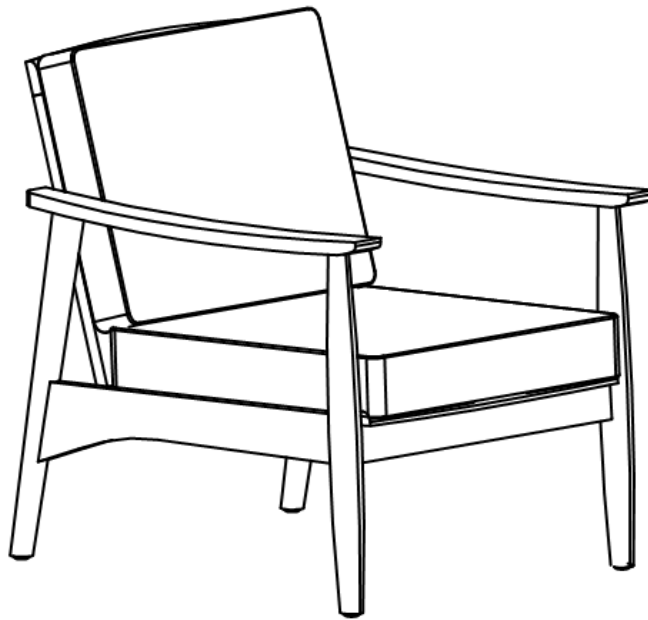







Caution: This Chair is NOT a TOY.

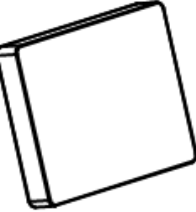

Keep your child/children at bay during the assembly process.

The Chair and its parts are heavy, whenever lifting or moving them, two adults are needed.

Parts List

Label	Picture	Description	Qty
A	 A line drawing of a wooden leg panel, showing a vertical leg and a horizontal crossbar.	Right Leg Panel	1
B	 A line drawing of a wooden leg panel, showing a vertical leg and a horizontal crossbar.	Left Leg Panel	1
C	 A line drawing of a rectangular seat panel with a slatted top surface.	Seat Panel	1
D	 A line drawing of a rectangular backrest panel with vertical slats.	Backrest Panel	1
E	 A line drawing of a rectangular back cushion.	Back Cushion	1
F	 A line drawing of a rectangular seat cushion.	Seat Cushion	1





Hardware

Label	Picture	Description	Qty
①		Bolt (M6*40mm)	5
②		Bolt (M6*50mm)	3
③		Allen Key	2

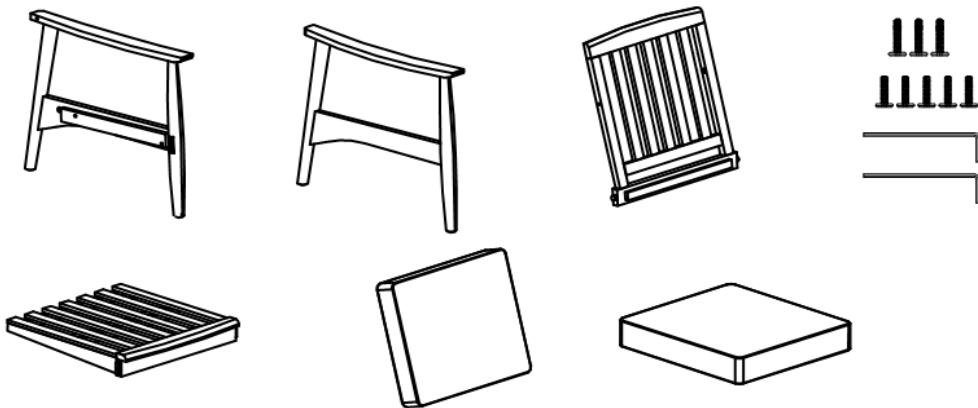
Assembly Preparation

Before Beginning Assembly:



-  • Read instruction, cover to cover-
-  • Have 2 adults on hand for assembly-
-  • Do not assembly on flooring or carpet-
-  • Assemble on a clena non- marring surface (packing foam)-
-  • Save all packaging until finished-

Assembly Steps

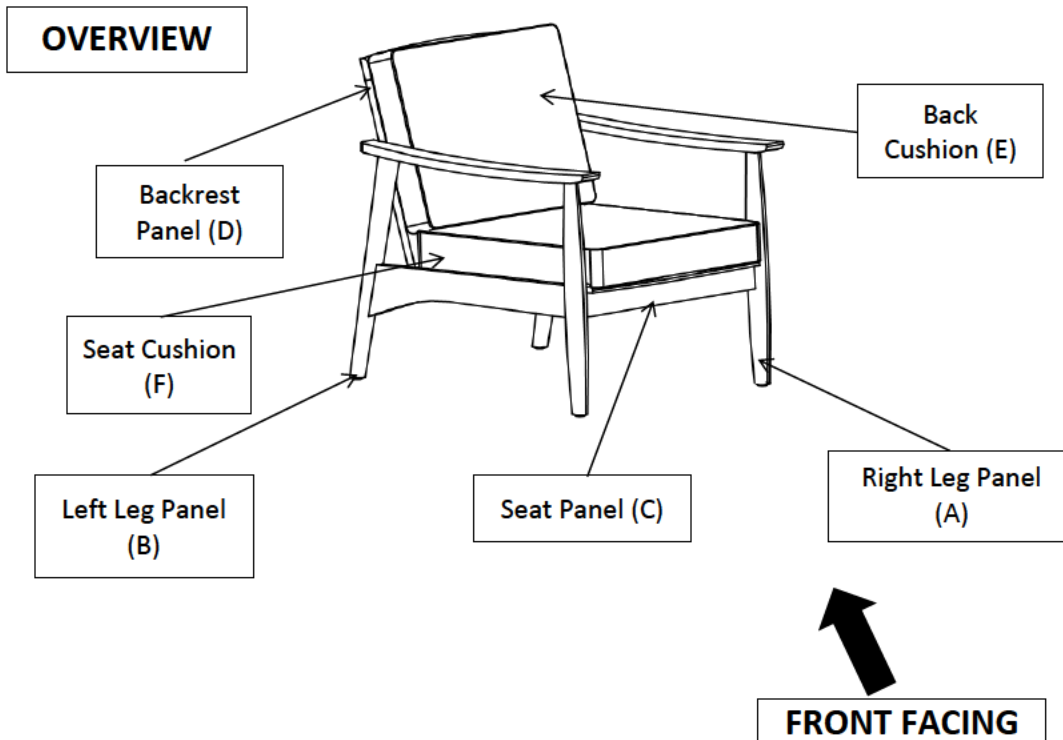

This Chair has multiple parts and may require up to some 30 minutes to assemble. To give you an overview of the Chair, the above picture is provided to help you put the various parts into perspective. Please read through the instructions below to familiarise yourself with the parts and steps before assembly.

Step 1

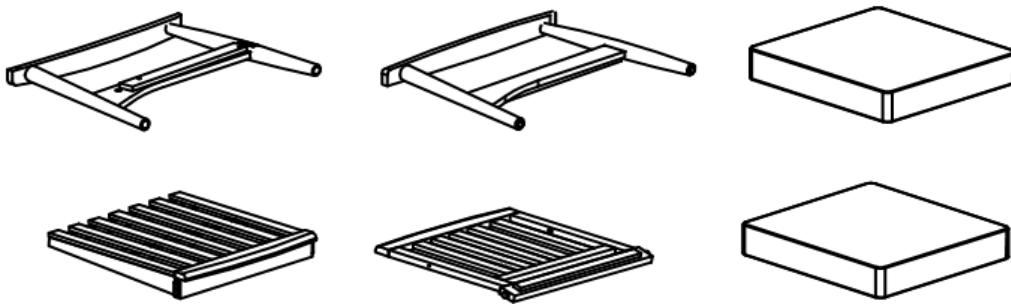

Unpack and place all the parts onto a clean, non-marring surface.

Step 2

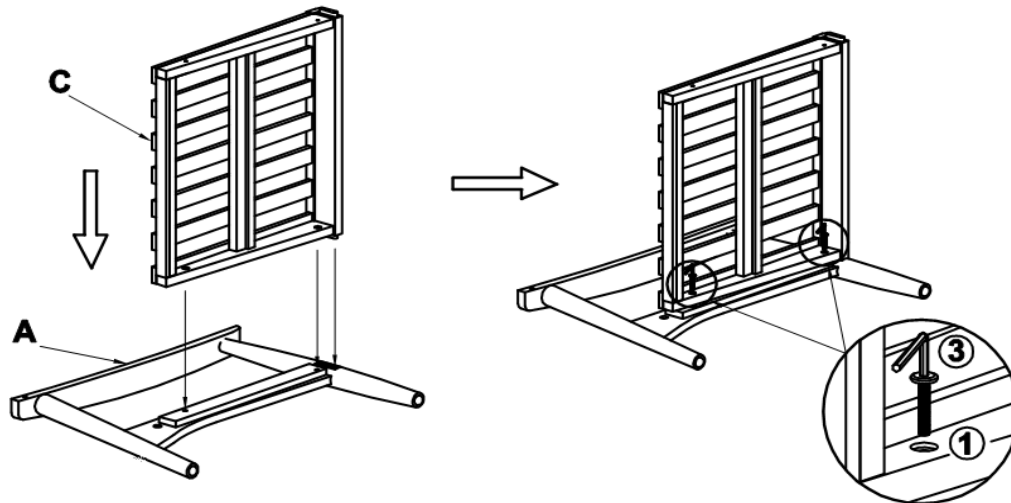

Position the Seat Panel(C) and the Right Leg Panel(A) as shown in the above picture. Then secure the Seat Panel(C) to the Right Leg Panel(A) using 2 Bolts(1) and the Allen Key(3).

Do not fully tighten the Bolts at this time.

Step 3

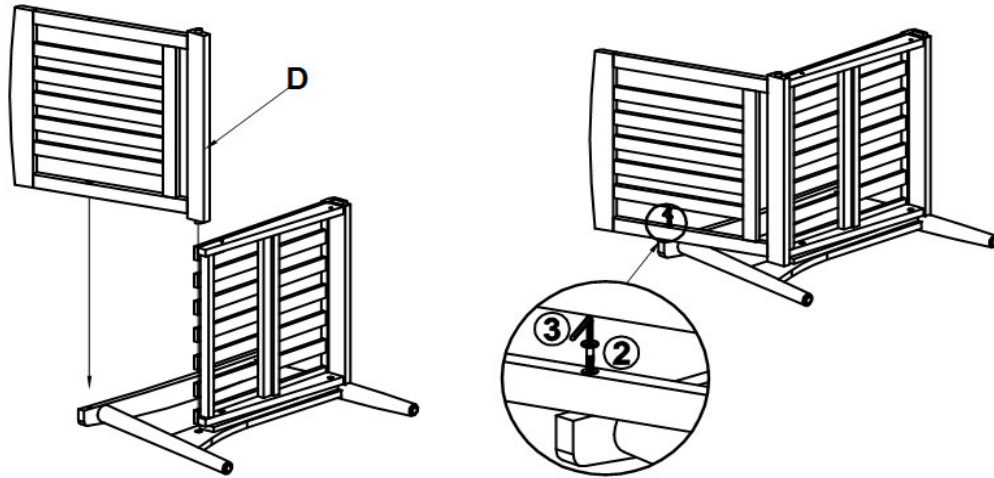

Position the Backrest Panel(D) to the Seat Panel(C) and the Right Leg Panel(A) as shown in the above picture.
Then using Bolts(②) and the Allen Key(③) secure the Backrest Panel(D) to the Right Leg Panel(A).
Do not fully tighten the Bolts at this time.

Step 4

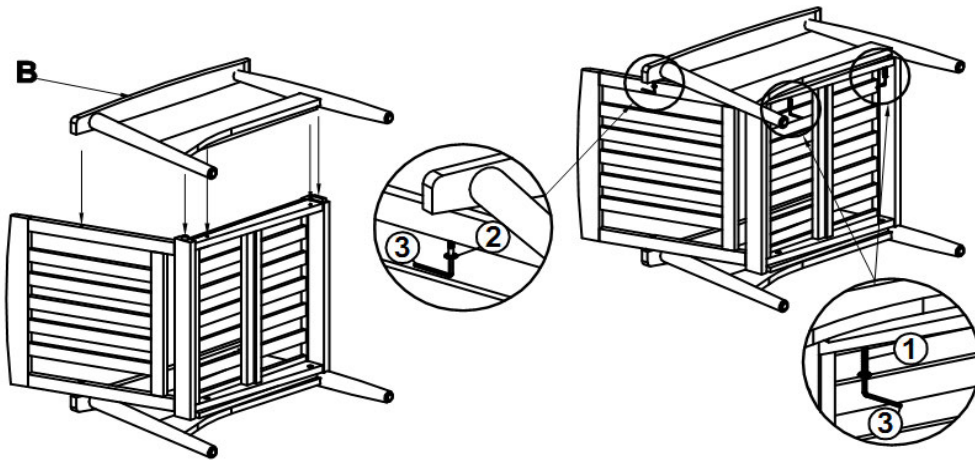

Position the Left Leg Panel(B) to the Seat Panel(C) and the Backrest Panel(D) as shown in the above picture.
Repeat the same process of Step 2 to secure the Left Leg Panel(B) to the Seat Panel(C) using 2 Bolts(①) and the Allen Key(③).
Then repeat the same process of Step 3 to secure the Left Leg Panel(B) to the Backrest Panel(D) using Bolts(②) and the Allen Key(③).
Do not fully tighten the Bolts at this time.

Step 5

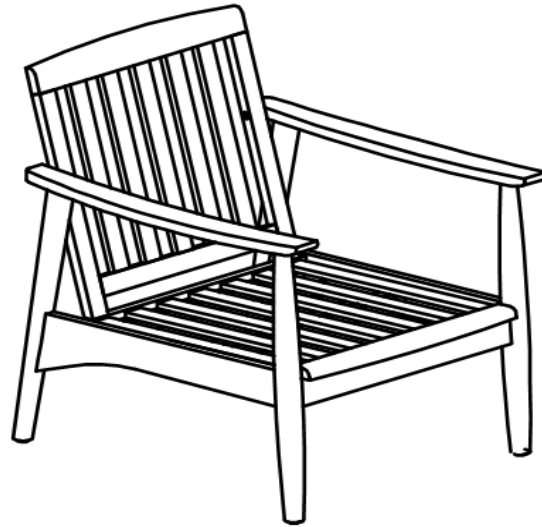

Stand the Chair up, with assistance from your adult partner.
Exert pressure floorwards onto the Chair with both your hands.
This pressure will help the Legs and Chair reach full alignment status.
Check for wobbles on a LEVEL surface.
If no wobbles are found proceed to tighten the Bolts in a sequential manner, until evenly secured.
When tightening the Bolts, tighten sequentially.
Do not tighten any Bolt fully and then move on towards the next one.
If the chair wobbles after tightening, loosen the Bolts and execute the same above process again.

Step 6

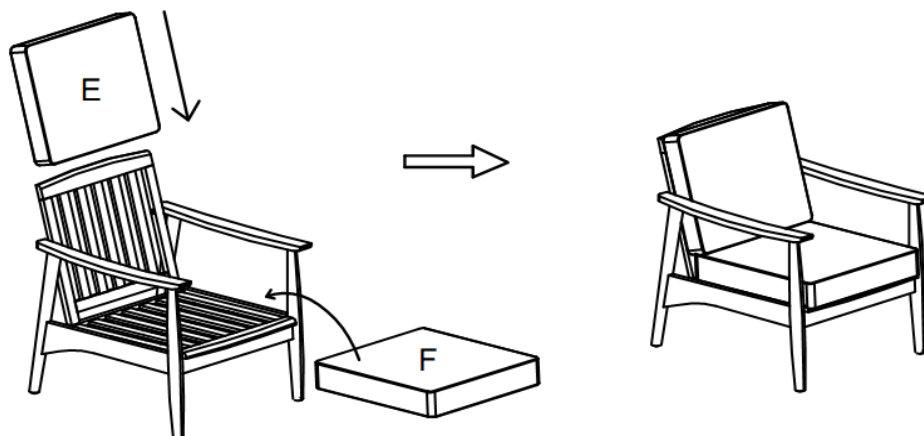

Place the Back Cushion(E) and the Seat Cushion(F) onto the Chair as shown in the above picture.



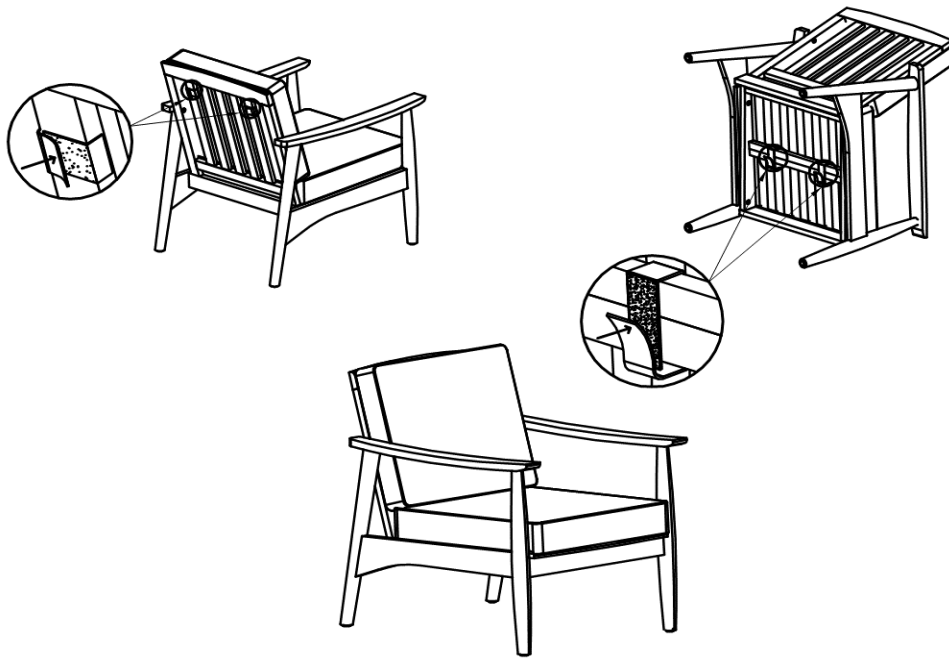





Step 7



Tie the velcro straps from the Back Cushion(E) to the Backrest Panel(D) and those on the Seat Cushion(F) to the Seat Panel(C) as shown in the above picture. Your Chair is now ready for use.

This Chair can only be used on a flat, level surface.

Care & Maintenance

- ⊗  ● Do not put hot items directly on furniture surface.
- ⊗  ● Do not clean furniture with harsh cleansers or polish.
- ✓  ● To obtain the longest lifespan of your outdoor products, minimizing exposure to direct sunlight is recommended.
- ⊗  ● Children should not climb or jump on the furniture.
- ⊗  ● Do not write on furniture without a padded barrier to protect the surface.
- ✓  ● To obtain the longest lifespan of your outdoor products, avoid extended and lengthy exposure to rain, snow, and direct sunshine. Whenever possible cover the product and /or place under patio or awnings.
- ⊗  ● Not for commercial use. For residential use only.
- ⊗  ● Stains may be removed with mild soap solution and damp cloth.
- ✓  ● Dust and pick-up spills using a clean, non-colored, lint-free cloth.