

ASSEMBLY INSTRUCTIONS

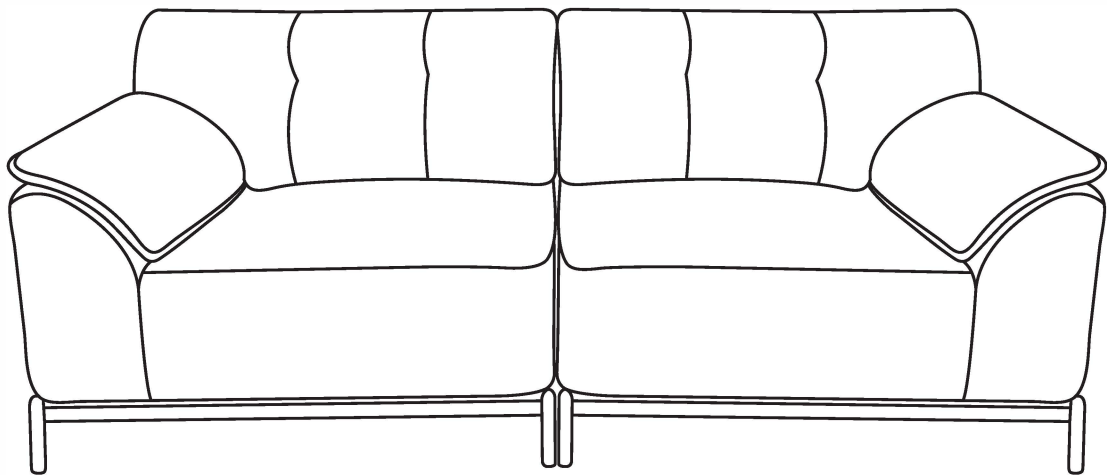

WARNING



Please read the instructions carefully and follow the assembly steps.

Do not tighten bolts or screws completely until all hardware is lined up and inserted into the holes.

Do not over-tighten screws and bolts to avoid stripping the hardware or cracking the item.

Assemble your item on a flat, carpeted area, with plenty of space to work. This will prevent damage and scratches to your floors or the item while you're assembling the product.

Keep all components and packaging out of reach of children or animals to avoid risk of choking or suffocation.

ASSEMBLY PARTS AND TOOL



BEFORE YOU GET STARTED. A FEW POINTERS:



Please use the included wrench instead of an ELECTRIC HAND DRILL in case of damage to the chair leg.

1

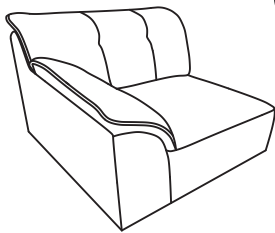

Sofa(Left)*1

2

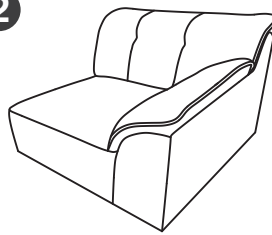

Sofa(Right)*1

A



Metal Frame*4

B

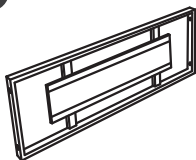

Metal Frame*4

C



Bolts *16

D



Flat Washer *16

E



Wrench *1

F



Connecting buckle*1

ASSEMBLY INSTRUCTIONS

STEP 1:

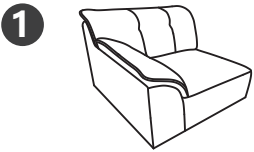

Sofa(Left)*1

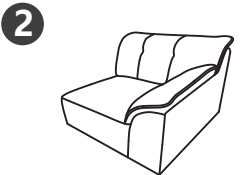

Sofa(Right)*1

Waiting rebound

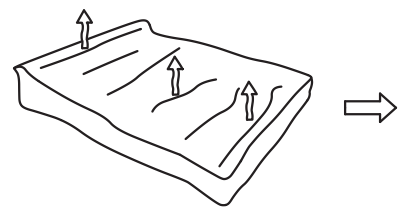

Please wait for 72 hours

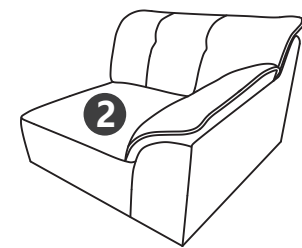
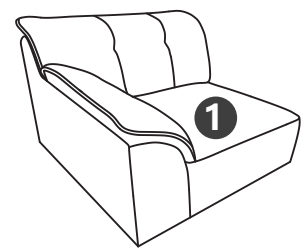

STEP 2:



Metal Frame*2

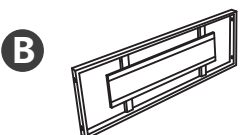

Metal Frame*2



Bolts *8



Flat Washer *8



Wrench *1

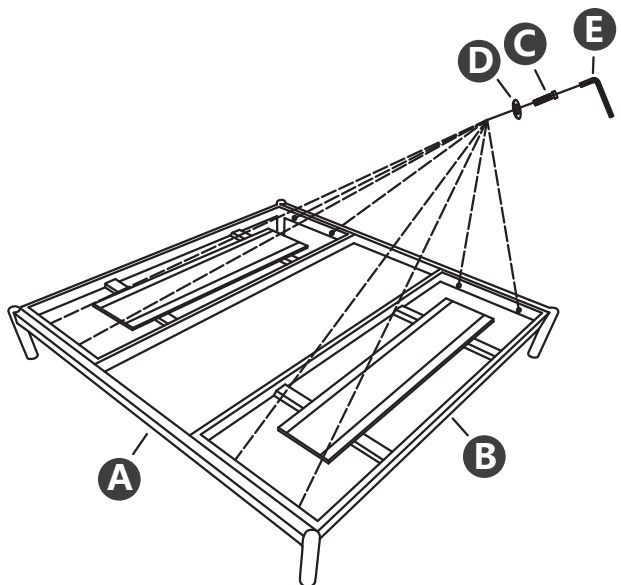

STEP 3:

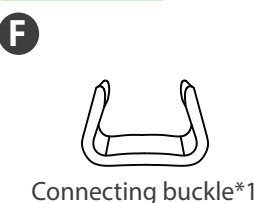

Connecting buckle*1

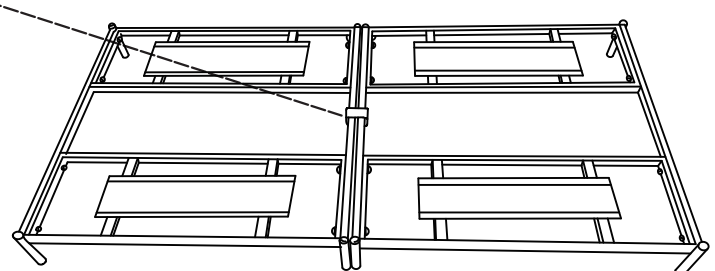
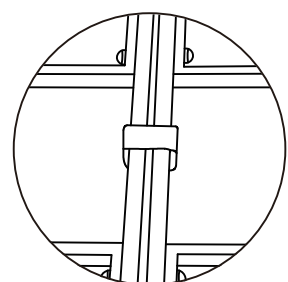

ASSEMBLY INSTRUCTIONS

STEP 4:

1

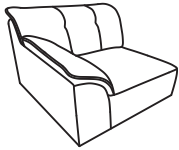

Sofa(Left)*1

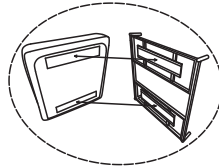
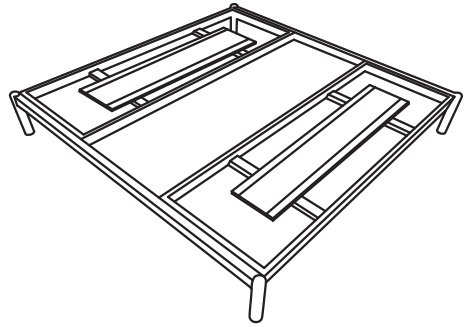
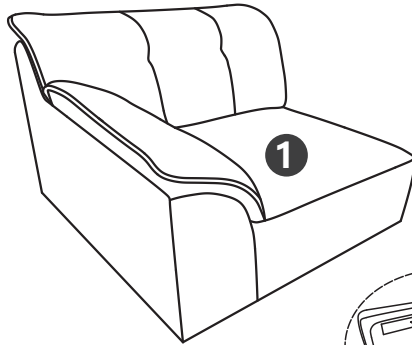

TIP: Before put the seat, please remove the non-woven fabric on the magic tape first

STEP 5:

2



Sofa(Right)*1

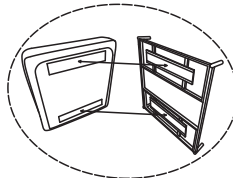
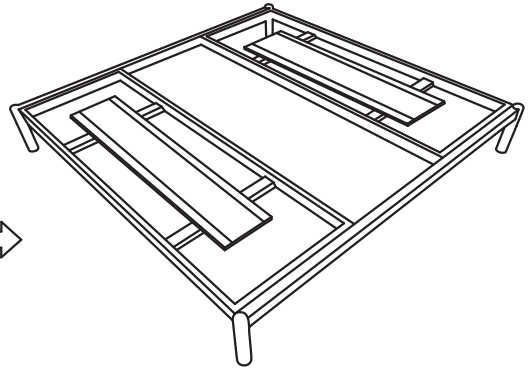
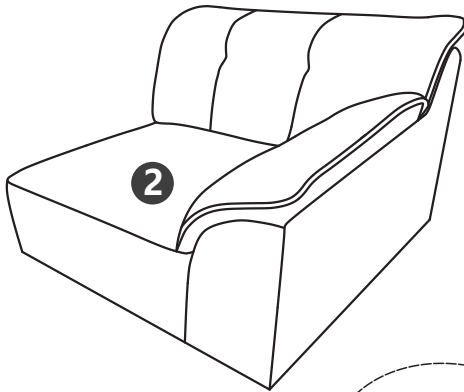

TIP: Before put the seat, please remove the non-woven fabric on the magic tape first

STEP 6:

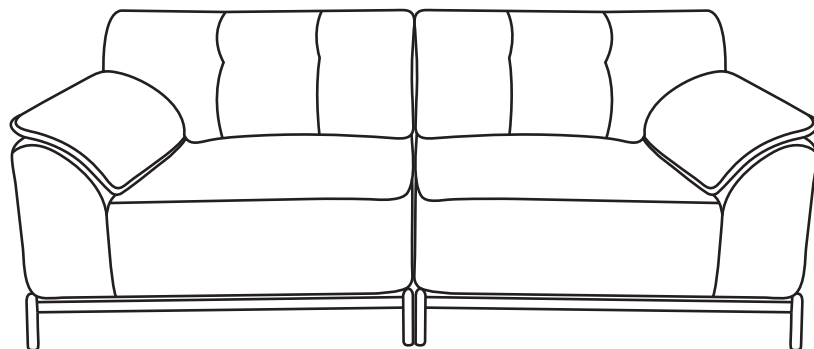

ASSEMBLY INSTRUCTIONS

Various combinations :

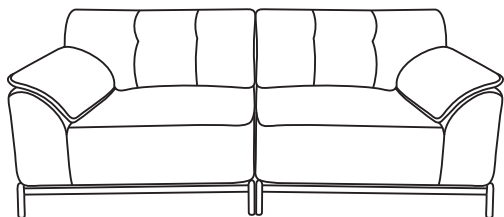

Loveseat

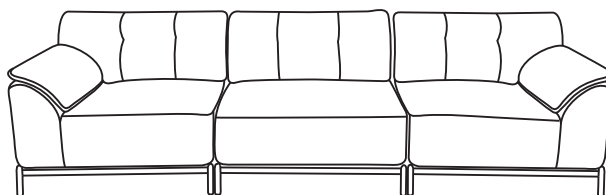

Sofa

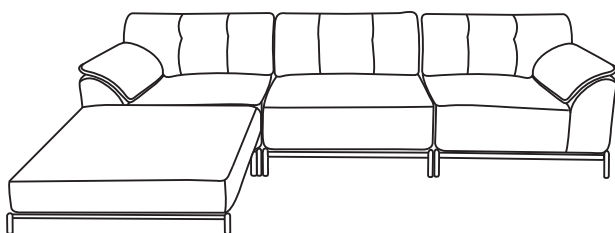

L-Shaped Sectional Sofa!

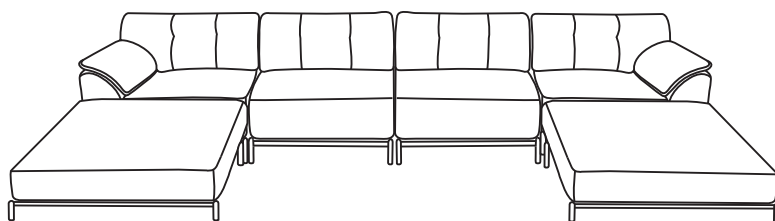

U-Shaped Sectional Sofa!

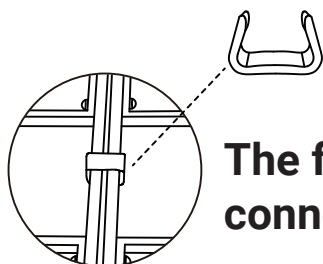

The frame between two seats can be connected by connecting buckles to achieve the fixing effect.

If you want to explore more combinations, please contact us in the store.

CARING FOR YOUR ITEM

Indoor use only

Not contract grade.

Clean using a non-abrasive cloth and a mild cleaner.

Never use harsh chemicals, as they could damage the finish or integrity of the item.
