

# ASSEMBLY INSTRUCTIONS

HYSC-014-HT

HYSC-014-ZS

HYSC-014-HS

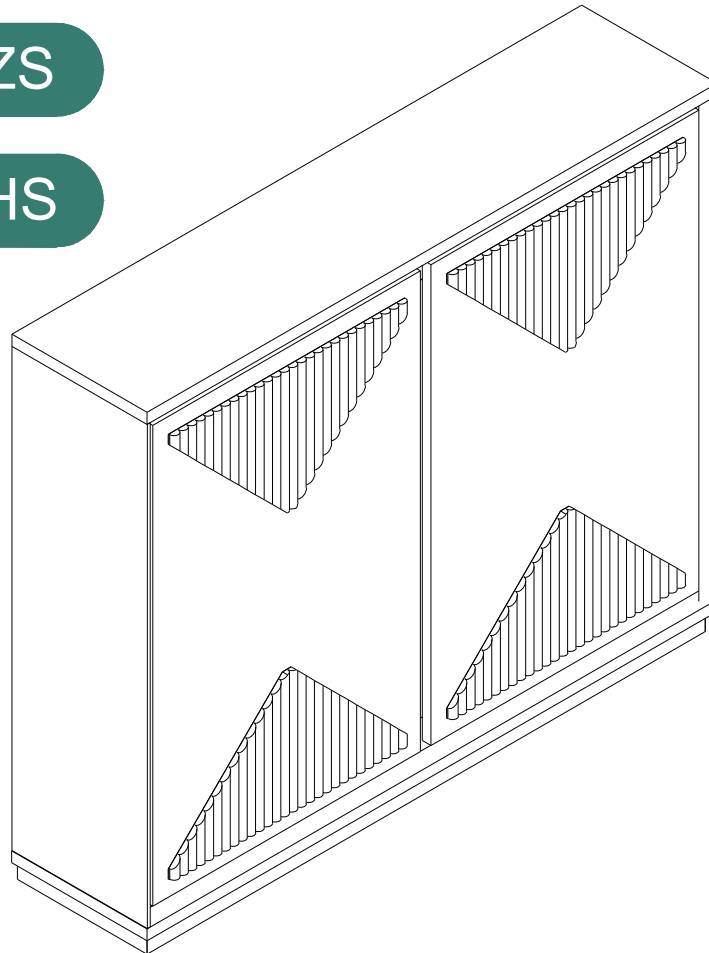

## Notice:

1. Follow the installation instructions. Please confirm all accessories are preset before installation.
2. Do not fully tighten the screws during initial assembly. Fully tighten screws only once all pieces which are correctly assembled.
3. If you encounter any problems during installation, please contact our customer service.
4. Please unbox the item from the side with an open-label and put a carpet on the floor to avoid scratching it.

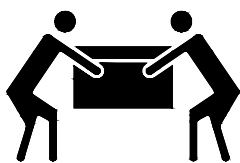

Recommended installers:2

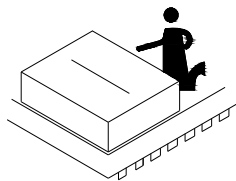

Put a carpet on the floor  
before unpacking

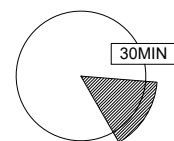

Estimate installation time:  
30minutes





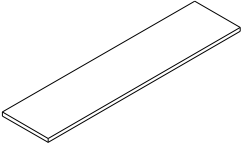
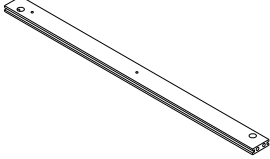
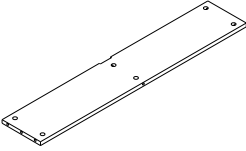
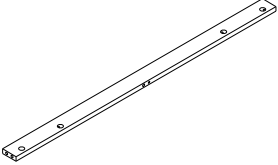
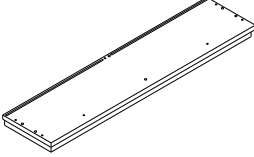
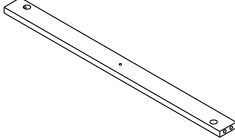
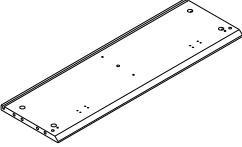
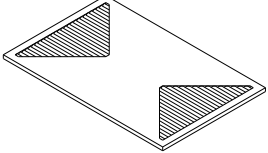
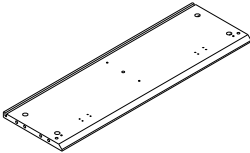
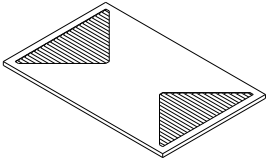
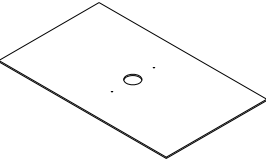

# ASSEMBLY INSTRUCTIONS

## PART LIST

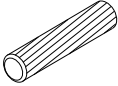
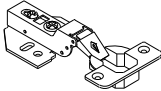
Item no.	Reference Image	Qty	Item no.	Reference Image	Qty
(A)		X1	(G)		X1
(B)		X1	(H)		X2
(C)		X1	(I)		X1
(D)		X1	(J)		X1
(E)		X1	(K)		X1
(F)		X2			

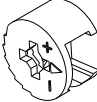
# ASSEMBLY INSTRUCTIONS

## HARDWARE LIST

Item no.	Reference Image	Qty	Item no.	Reference Image	Qty
1	 Ø8*30mm	X14+1	5		X4
2		X26+2	6		X4
3		X26+2	7	 Ø3*15mm	X4
4	 Ø3*12mm	X24+2	8		X2

# ASSEMBLY INSTRUCTIONS

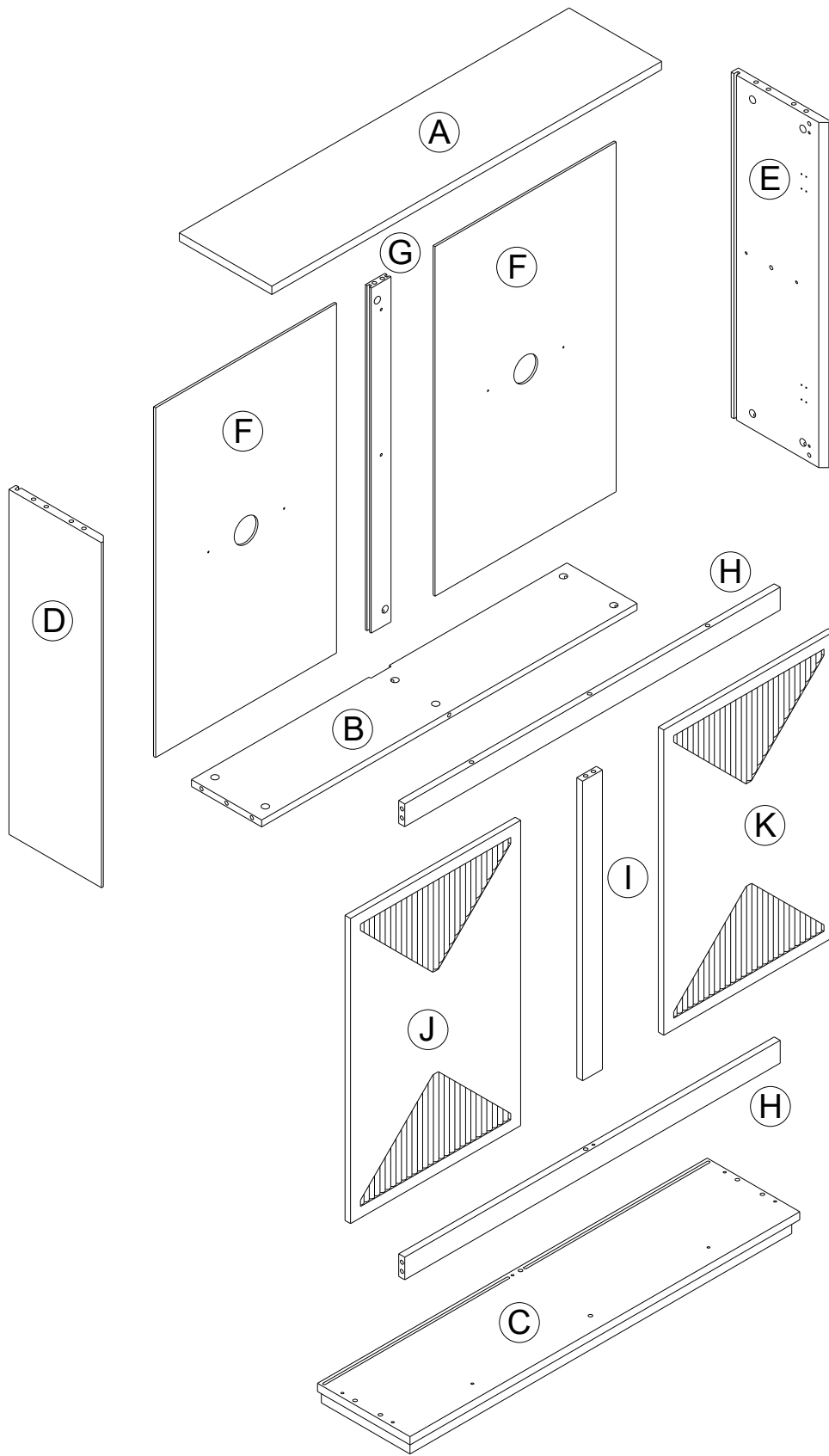

# ASSEMBLY INSTRUCTIONS

1

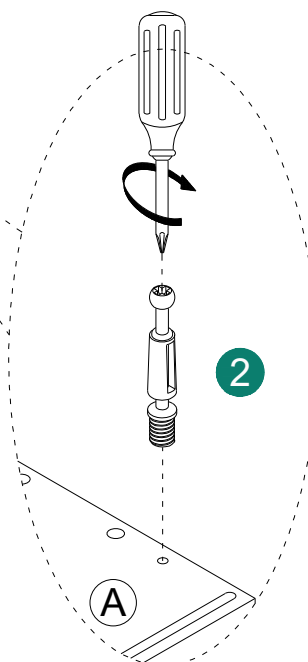
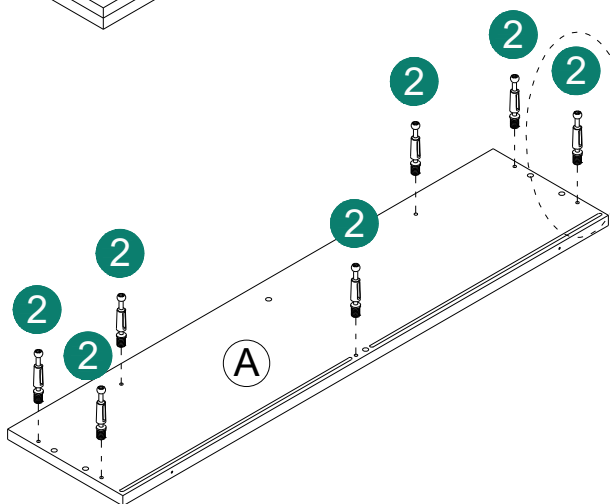
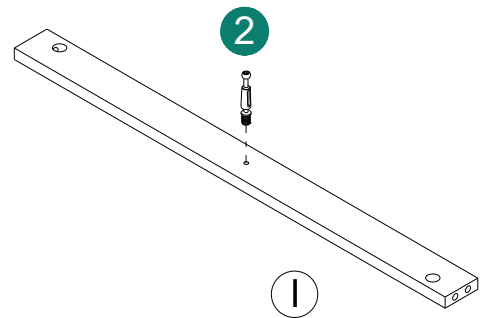
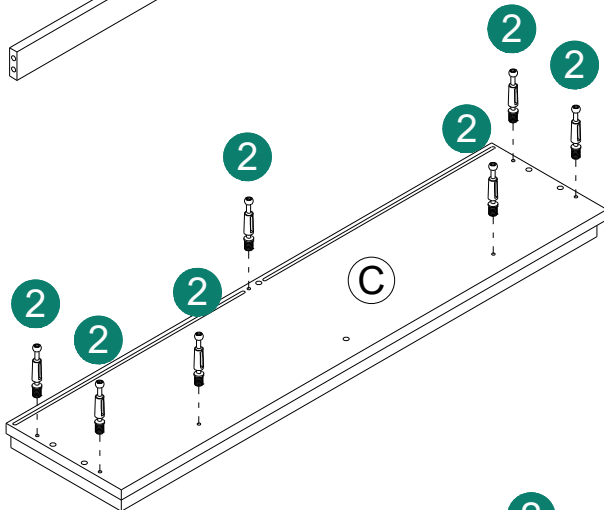
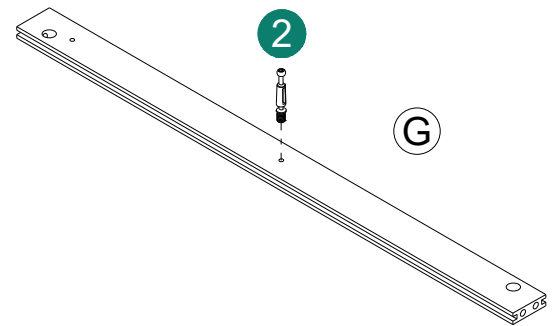
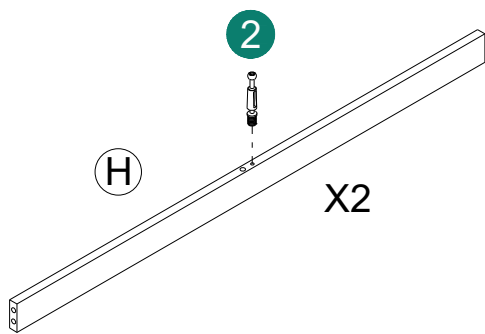
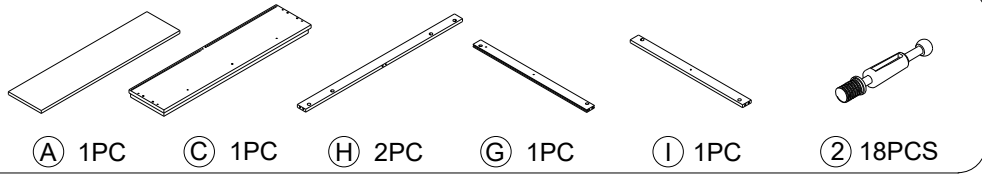

# ASSEMBLY INSTRUCTIONS

2

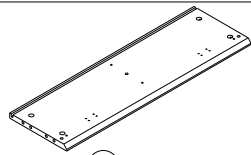

D 1PC

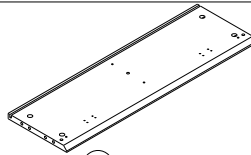

E 1PC



2 8PCS

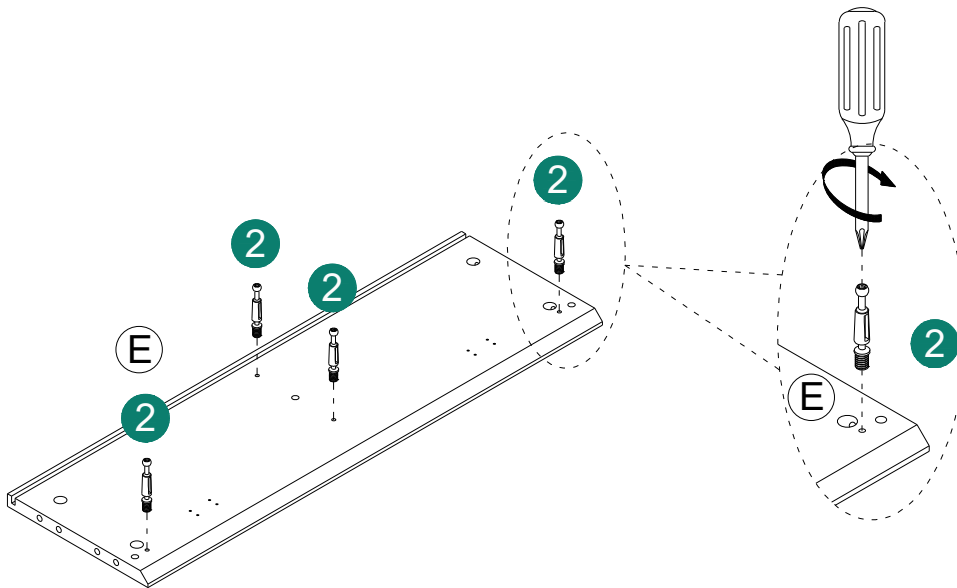
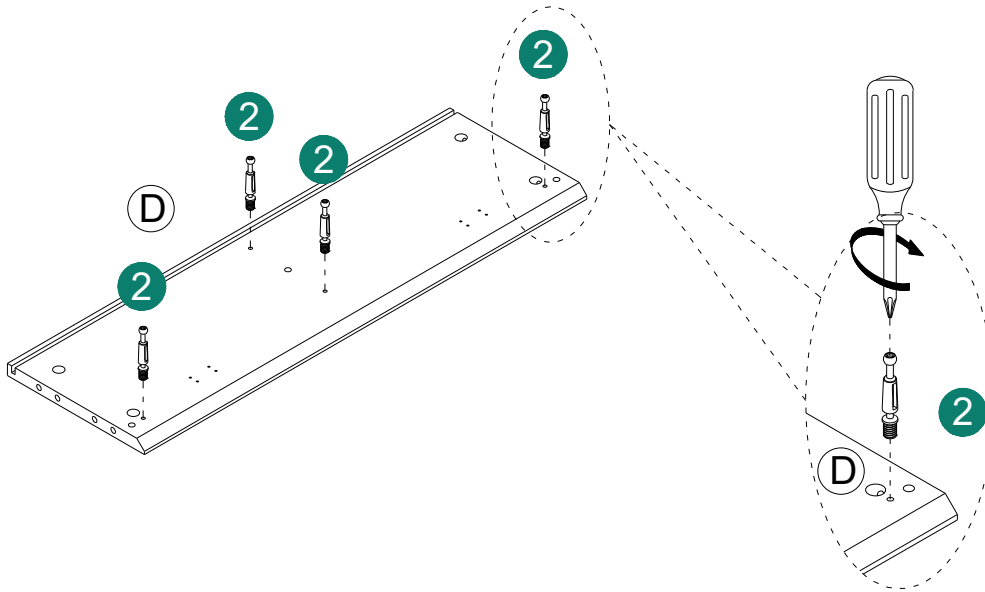

# ASSEMBLY INSTRUCTIONS

3

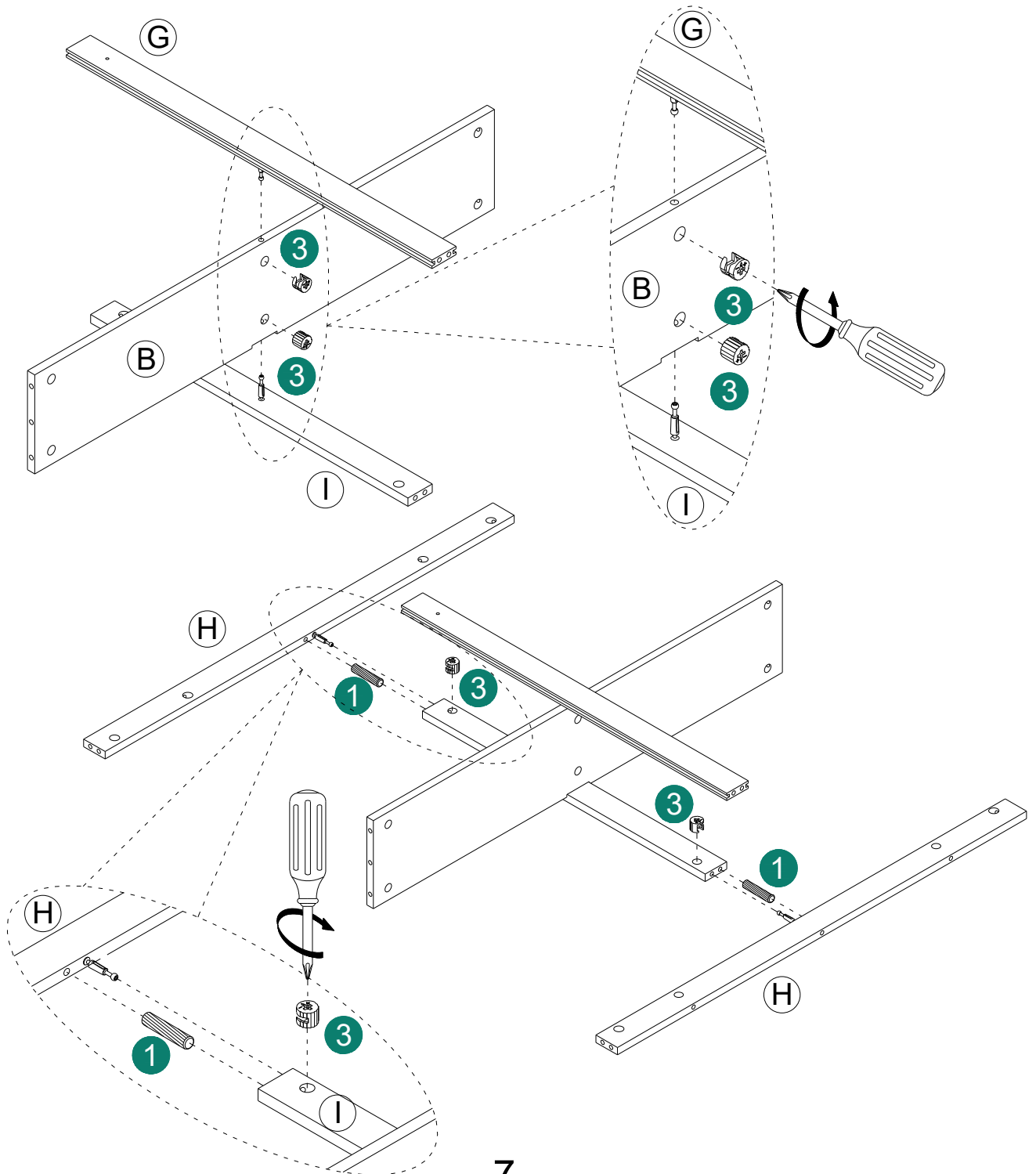
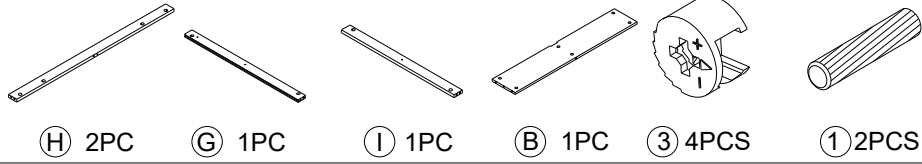

# ASSEMBLY INSTRUCTIONS

4

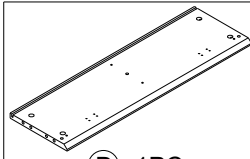

D 1PC

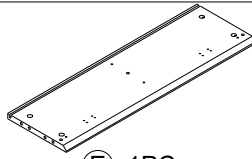

E 1PC

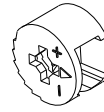

3 8PCS

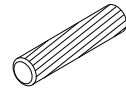

1 6PCS

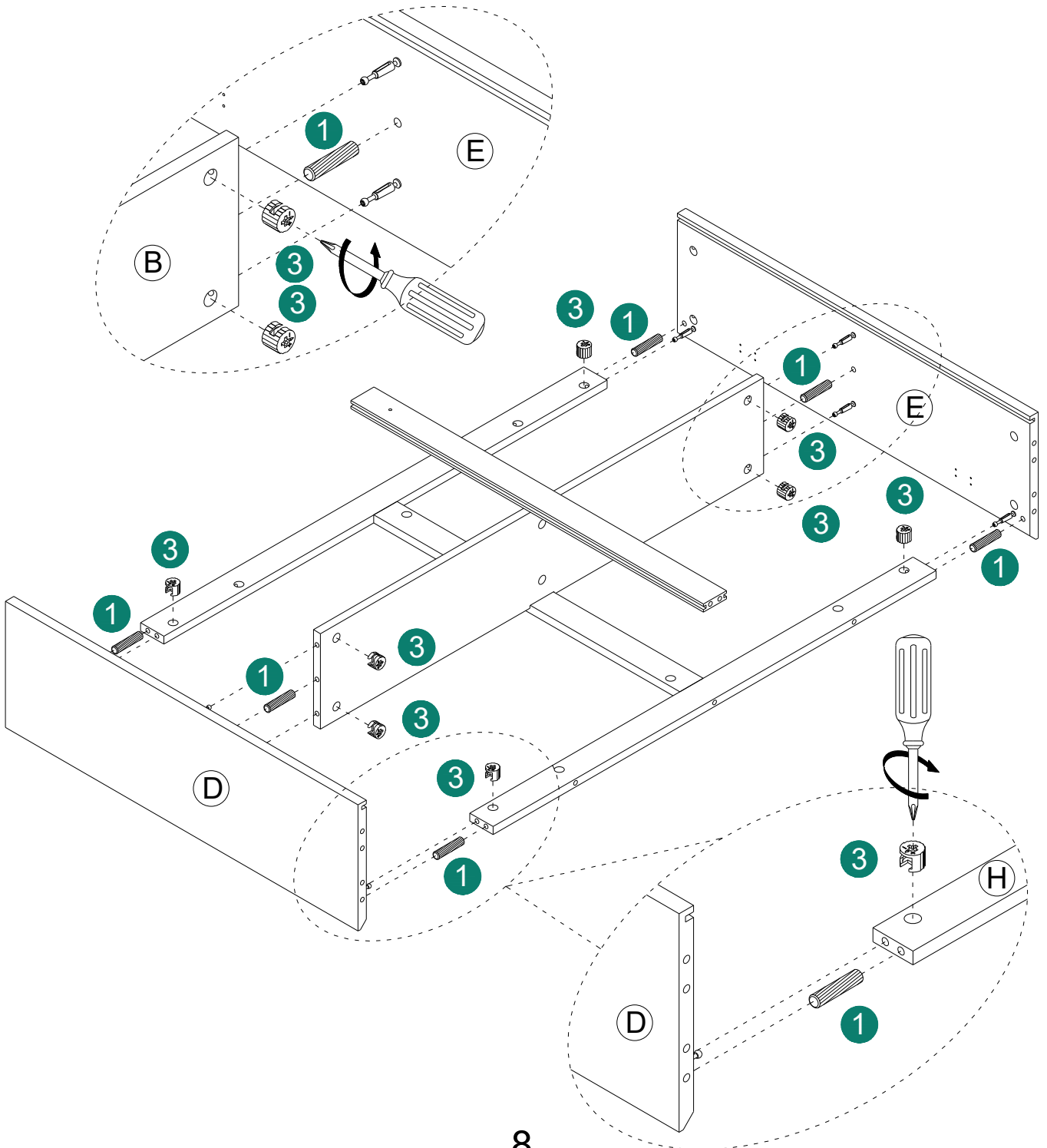



# ASSEMBLY INSTRUCTIONS

5

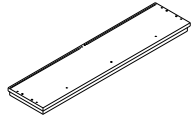

Ⓒ 1PC

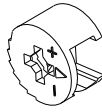

③ 7PCS

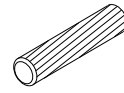

① 6PCS

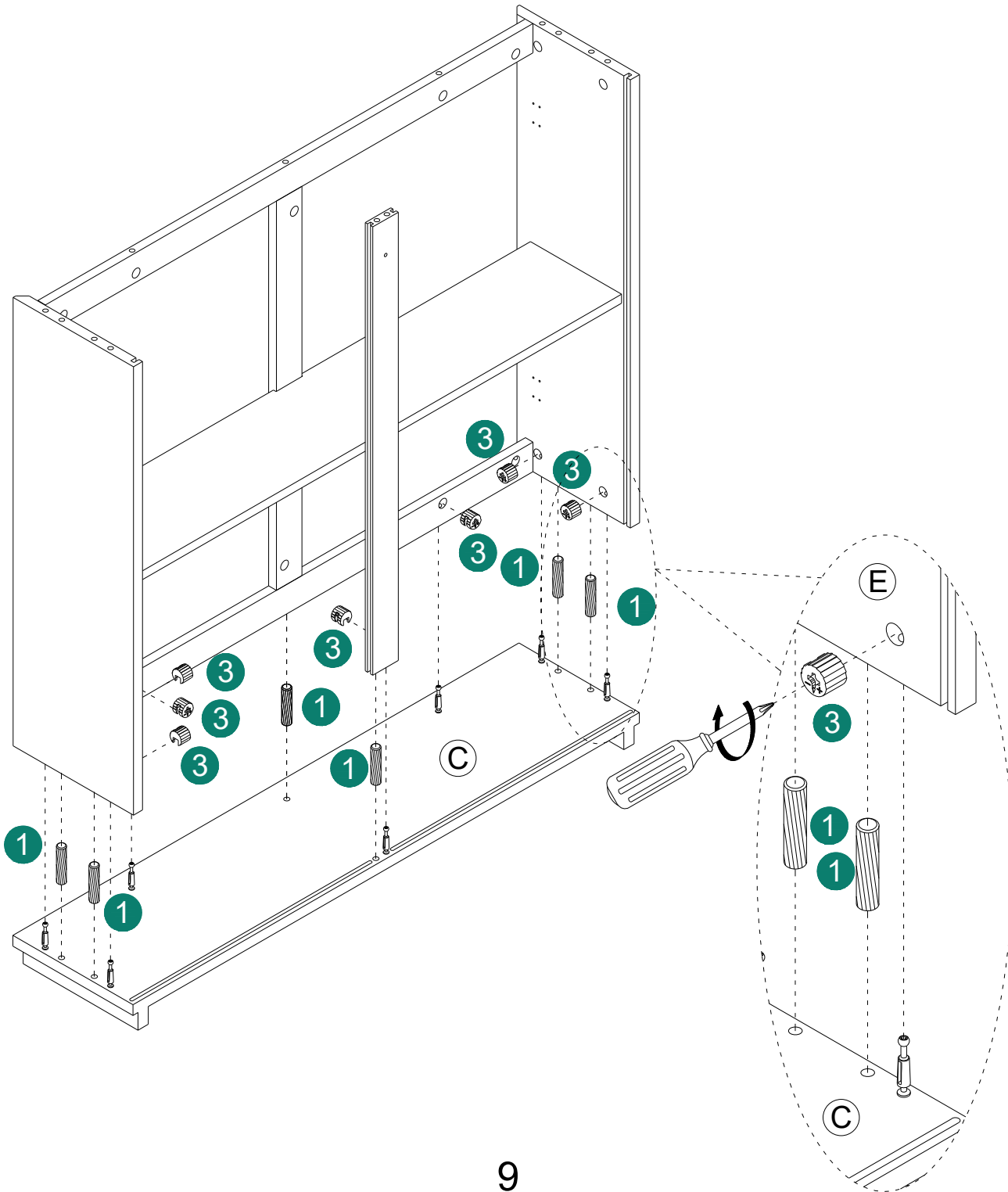

# ASSEMBLY INSTRUCTIONS

6

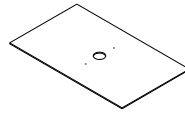

F 2PC

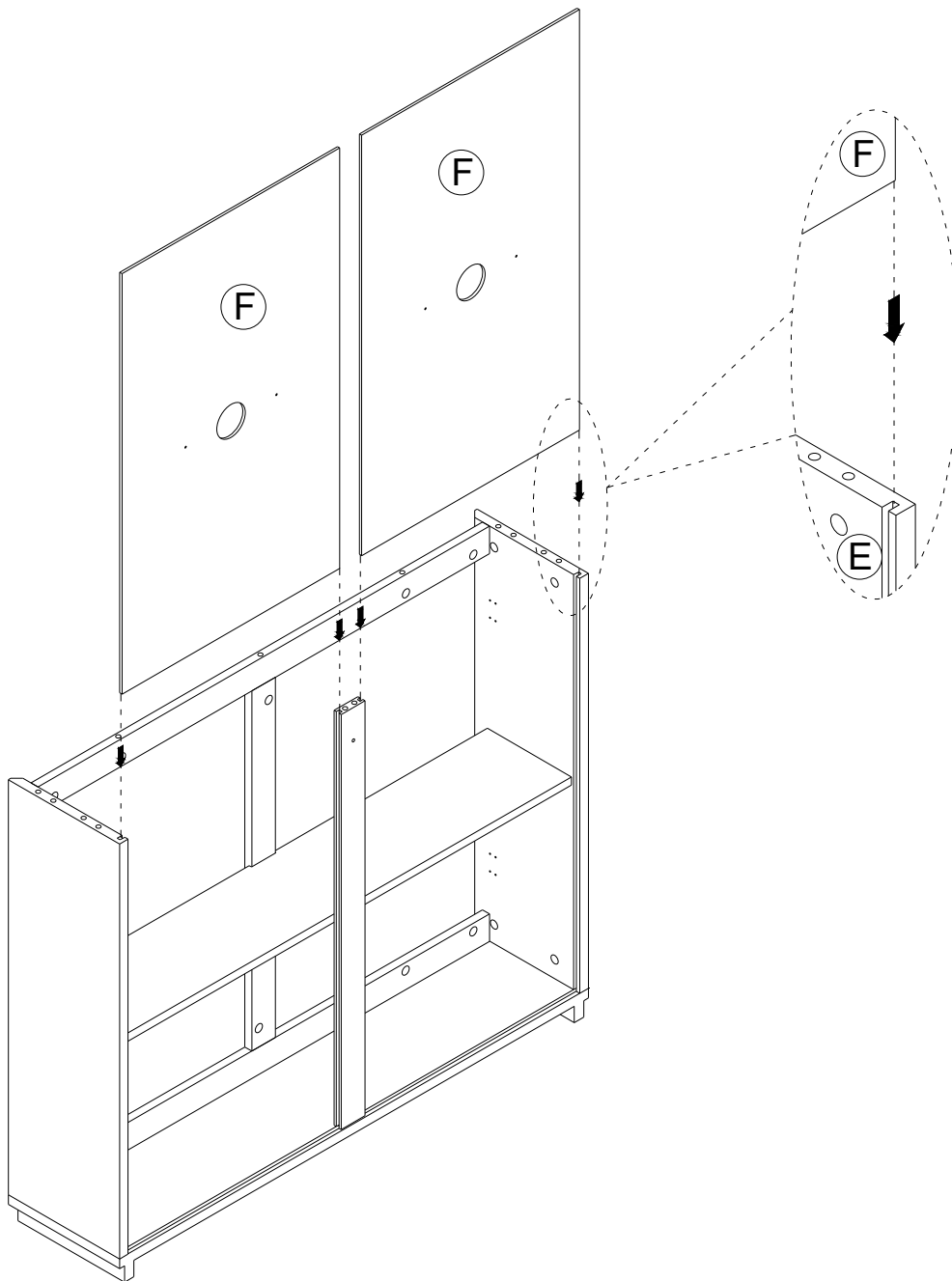

# ASSEMBLY INSTRUCTIONS

7

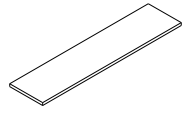

(A) 1PC

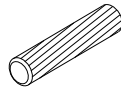

(1) 6PCS

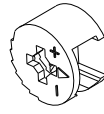

(3) 7PCS

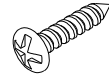

(7) 4PCS

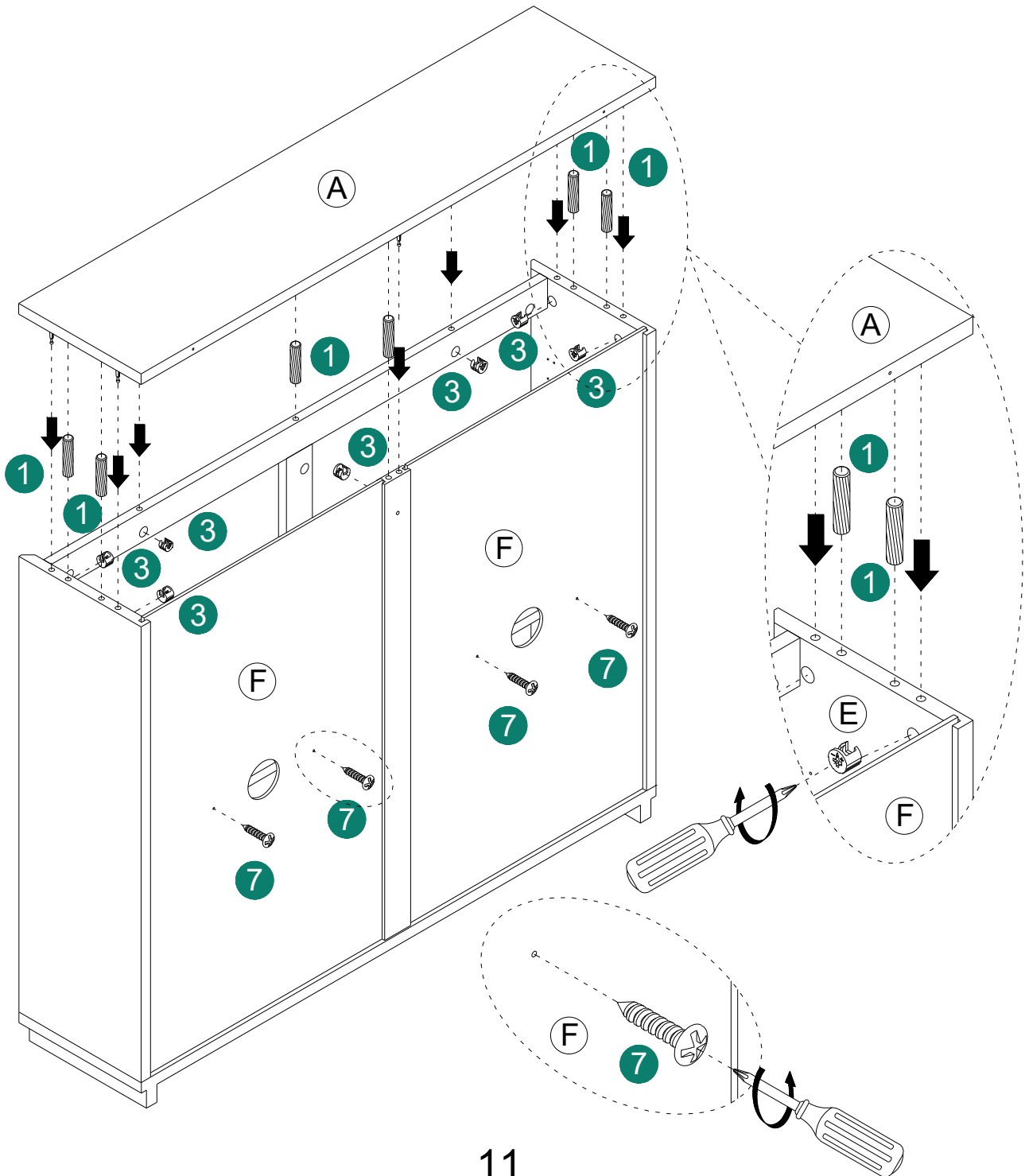

# ASSEMBLY INSTRUCTIONS

8

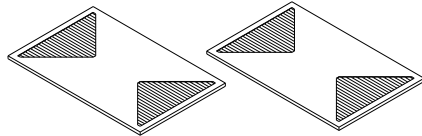

(J) 1PC

(K) 1PC

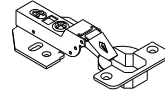

(5) 4PCS

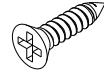

(4) 8PCS

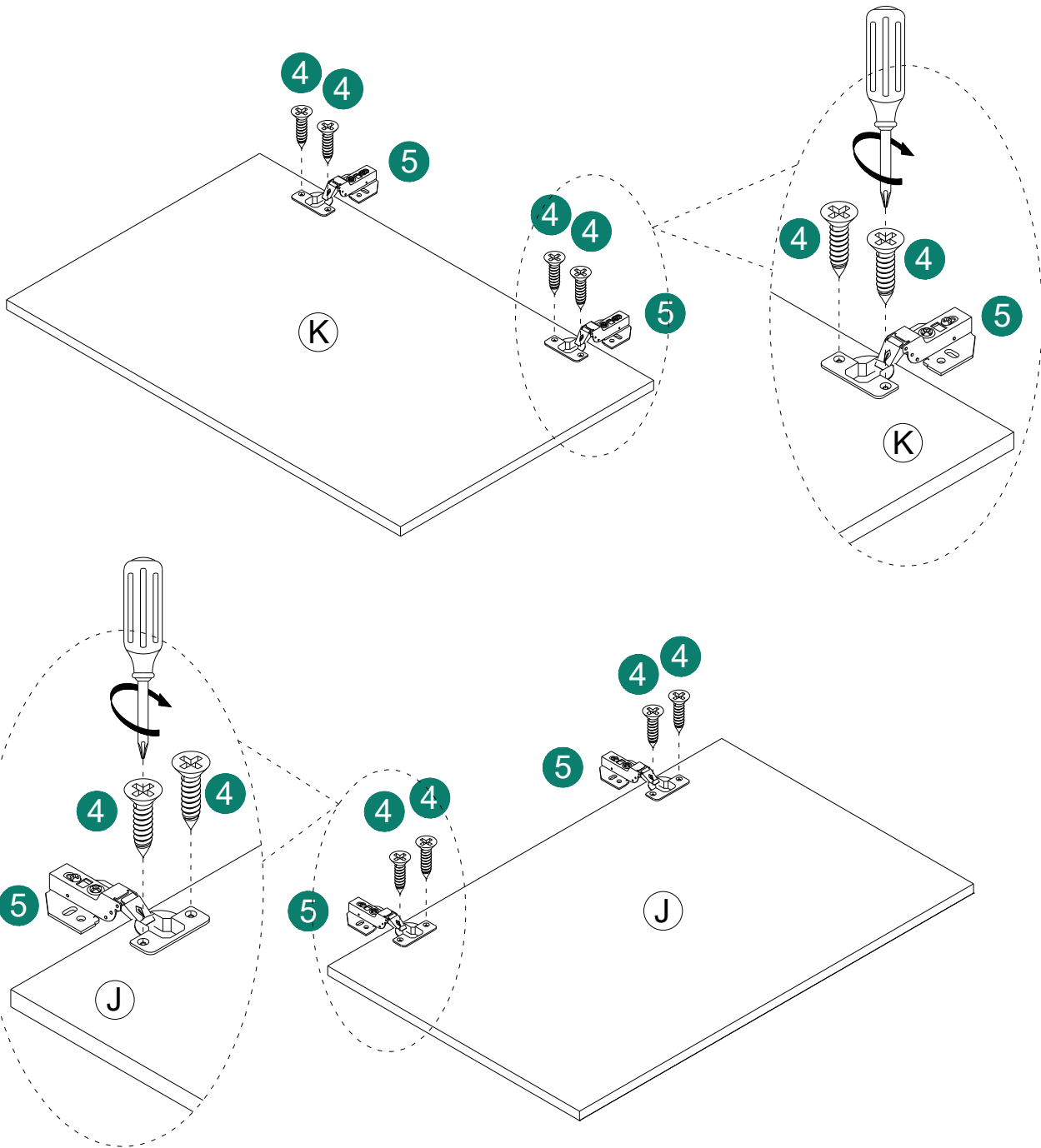

# ASSEMBLY INSTRUCTIONS

9

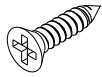

④ 16PCS

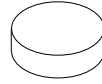

⑥ 4PCS

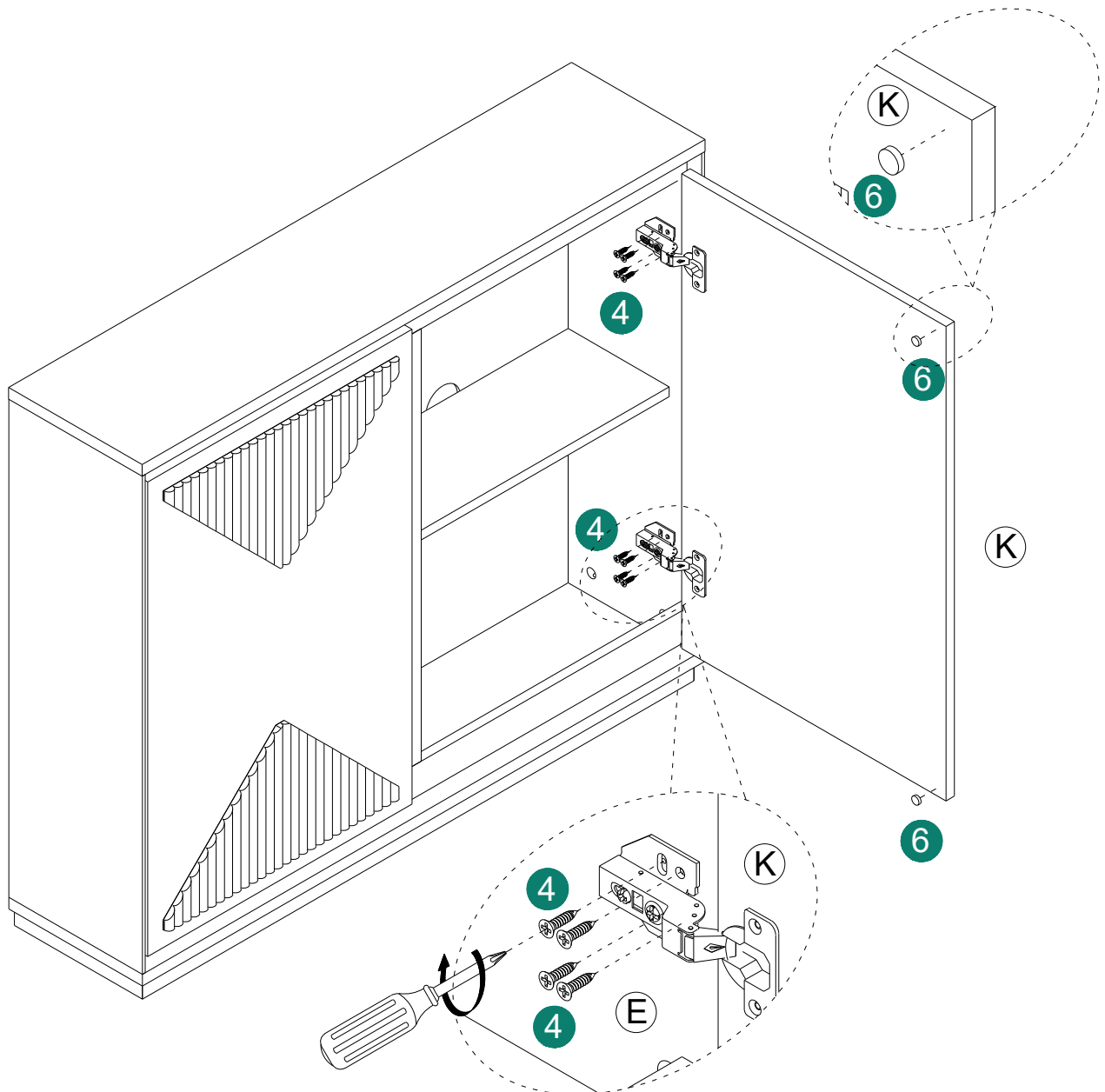

# ASSEMBLY INSTRUCTIONS

# 10

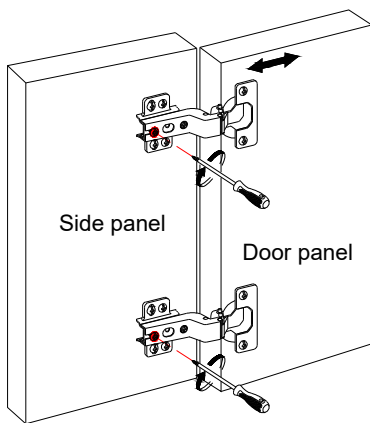

①

## Front-to-Back Direction Adjustment:

Rotate the screws on the door hinges shown in the image. The door panel can be moved front-back.

Adjustment range: 4mm

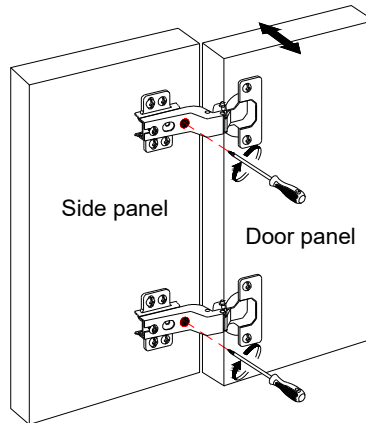

②

## Left-Right Direction Adjustment:

Rotate the screws on the door hinges shown in the image. The door panel can be moved left-right.

Adjustment range: 3mm

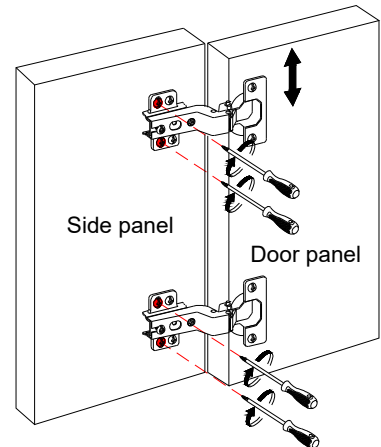

③

## Up-Down Direction Adjustment:

Rotate the screws on the door hinges shown in the image. The door panel can be moved up-down.

Adjustment range: 4mm

# ASSEMBLY INSTRUCTIONS

11

## Common Door Panel Issues:

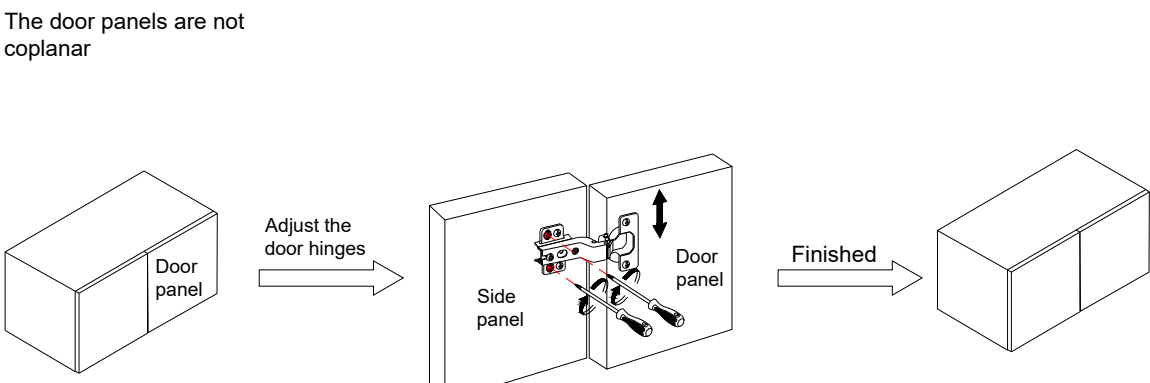
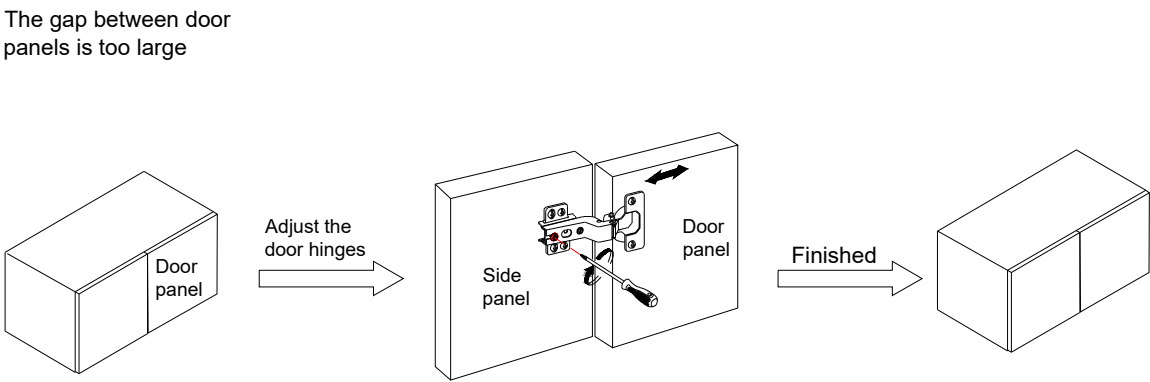
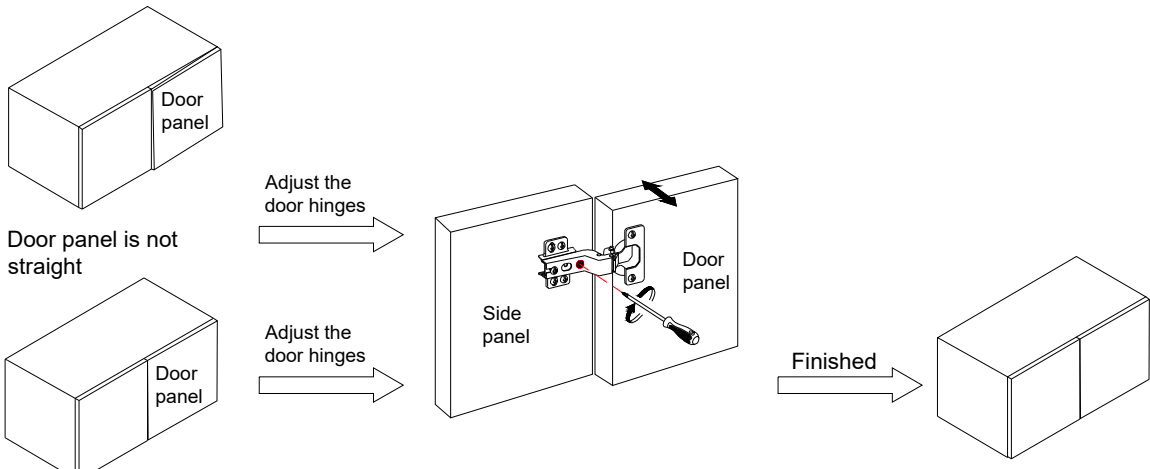

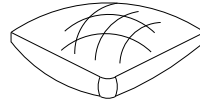

# ASSEMBLY INSTRUCTIONS

12

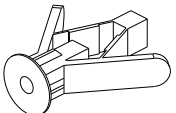

8 2set

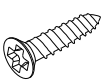
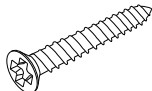
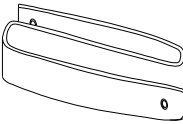
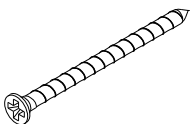
A	B	C	D	E	F
					
3pcs	5pcs	Ø8*3/4" 2pcs	Ø8*1-1/2" 2pcs	2pcs	Ø8*2" 1pcs

