

ASSEMBLY INSTRUCTIONS

TWIN HOUSE BUNK BED

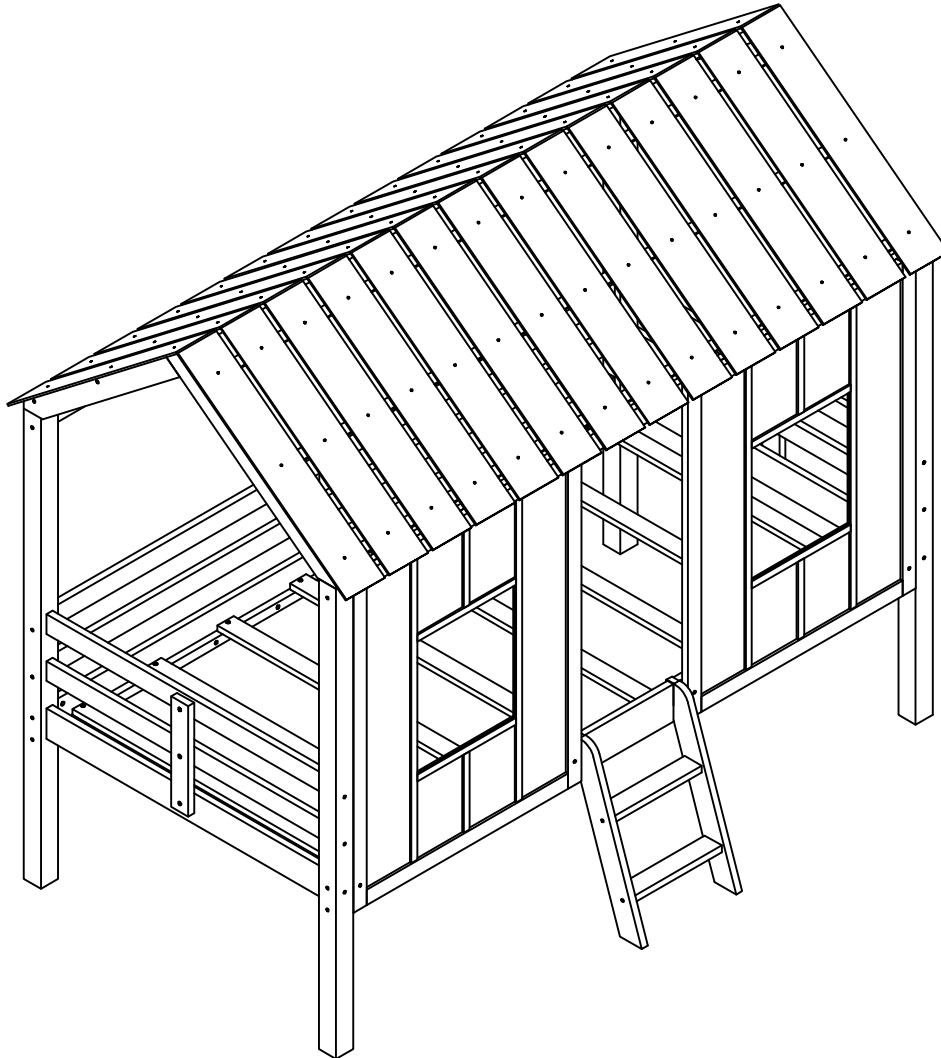

PLEASE DO NOT RETURN PRODUCT TO THE STORE.

If you have any problem or concerns, please feel free to contact our customer service department. We will reply you as soon as possible.

ASSEMBLY INSTRUCTIONS

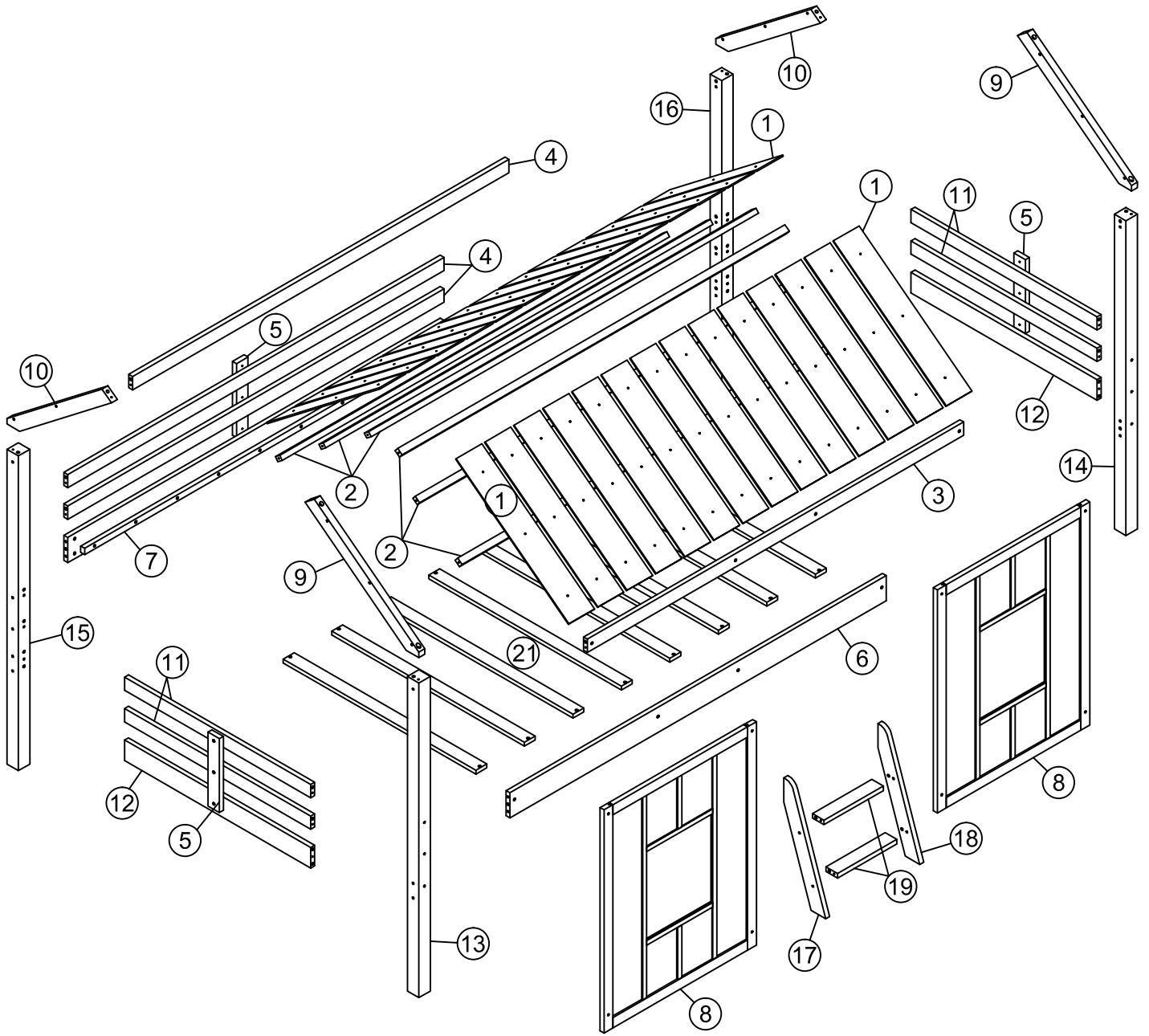

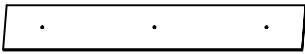
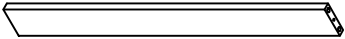
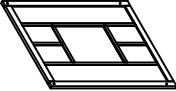
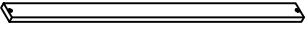
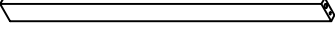





1	 Roof panels	28pcs	12	 Head board panels	2pcs
8	 Window frames	2pcs	21	 Slats	8pcs
11	 Head board panels	4pcs			

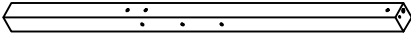

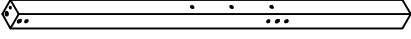

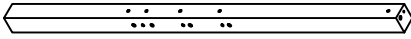

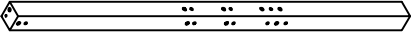
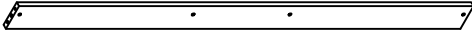
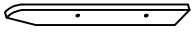
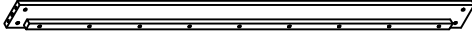
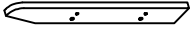
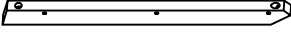
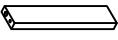
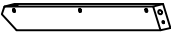



ASSEMBLY INSTRUCTIONS

PARTS LIST

(Hardware in this SKU)

2	 Roof top support	6pcs	13	 Left front leg	1pc
3	 Roof front support	1pc	14	 Right front leg	1pc
4	 Back guard rails	3pcs	15	 Left back leg	1pc
5	 Guard rail support	3pcs	16	 Right back leg	1pc
6	 Upper front side rail	1pc	17	 Ladder - left leg	1pc
7	 Upper back side rail	1pc	18	 Ladder - right leg	1pc
9	 Roof - front support	2pcs	19	 Ladder steps	2pcs
10	 Roof - back support	2pcs			





HARDWARE LIST ()

A	Ø4x30		25PCS	G	1/4x110		8PCS
B	Ø4x25		84PCS	H	1/4x35		8PCS
C	Ø4x15		6PCS	I	Ø10x40		38PCS
D	6.5x100		20PCS	J	70x18x2		2PCS
E	6.5x80		14PCS	K	4x58		1PC
F	6.5x60		8PCS				

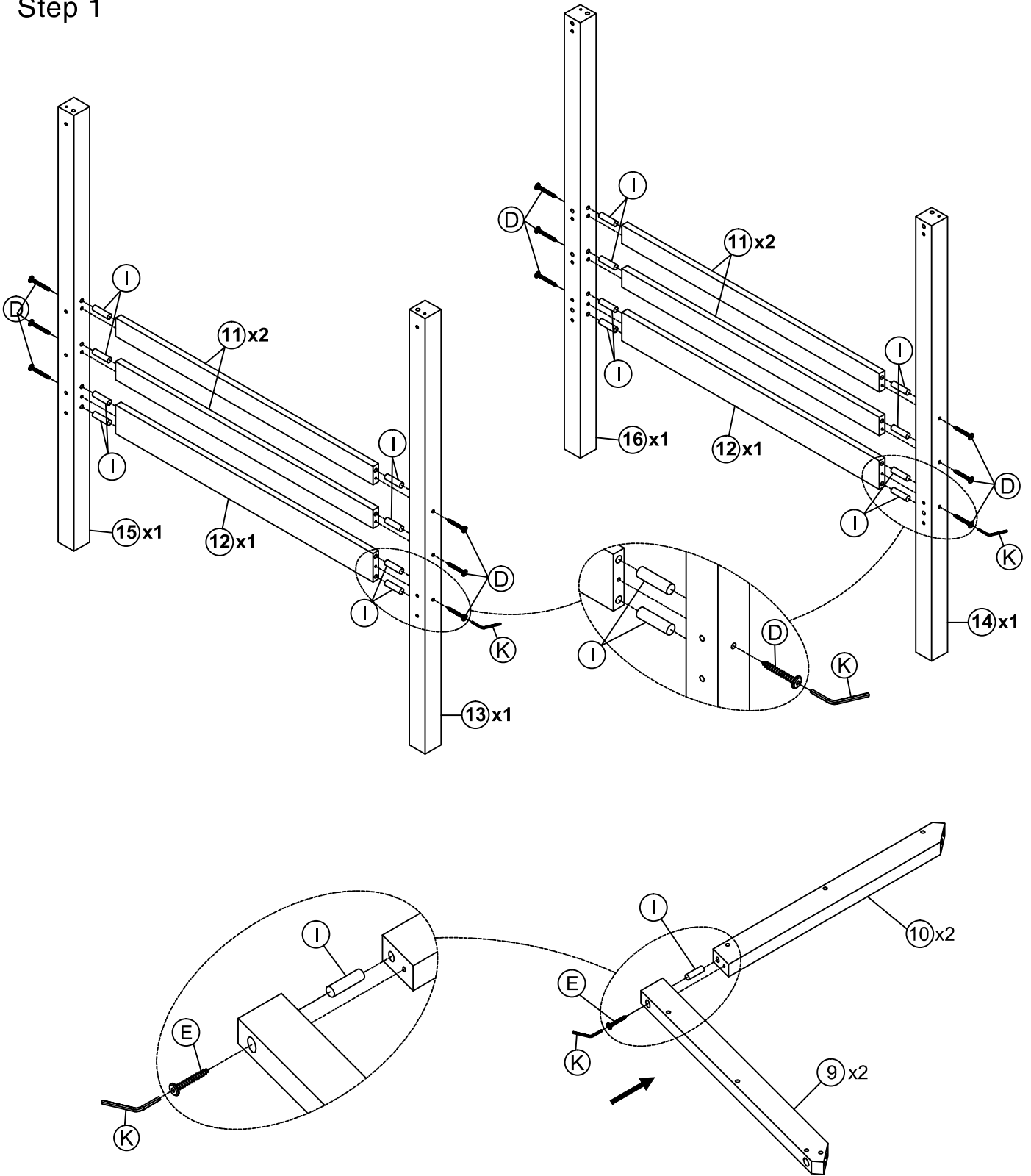
ASSEMBLY INSTRUCTIONS

Step 1





K	4x58		1PC	E	6.5x80		2PCS
I	Ø10x40		18PCS	D	6.5x100		12PCS

ASSEMBLY INSTRUCTIONS

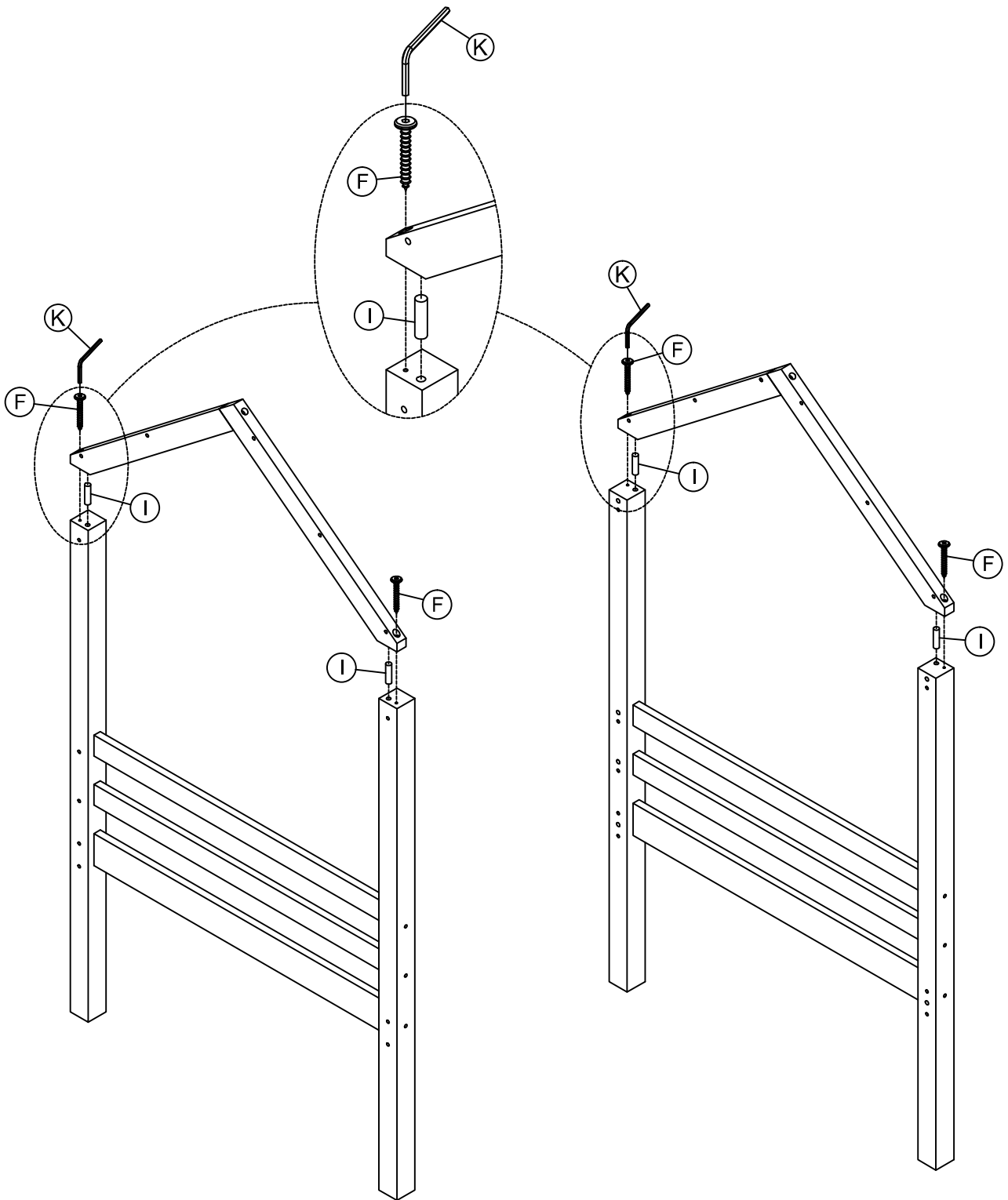
Step 2





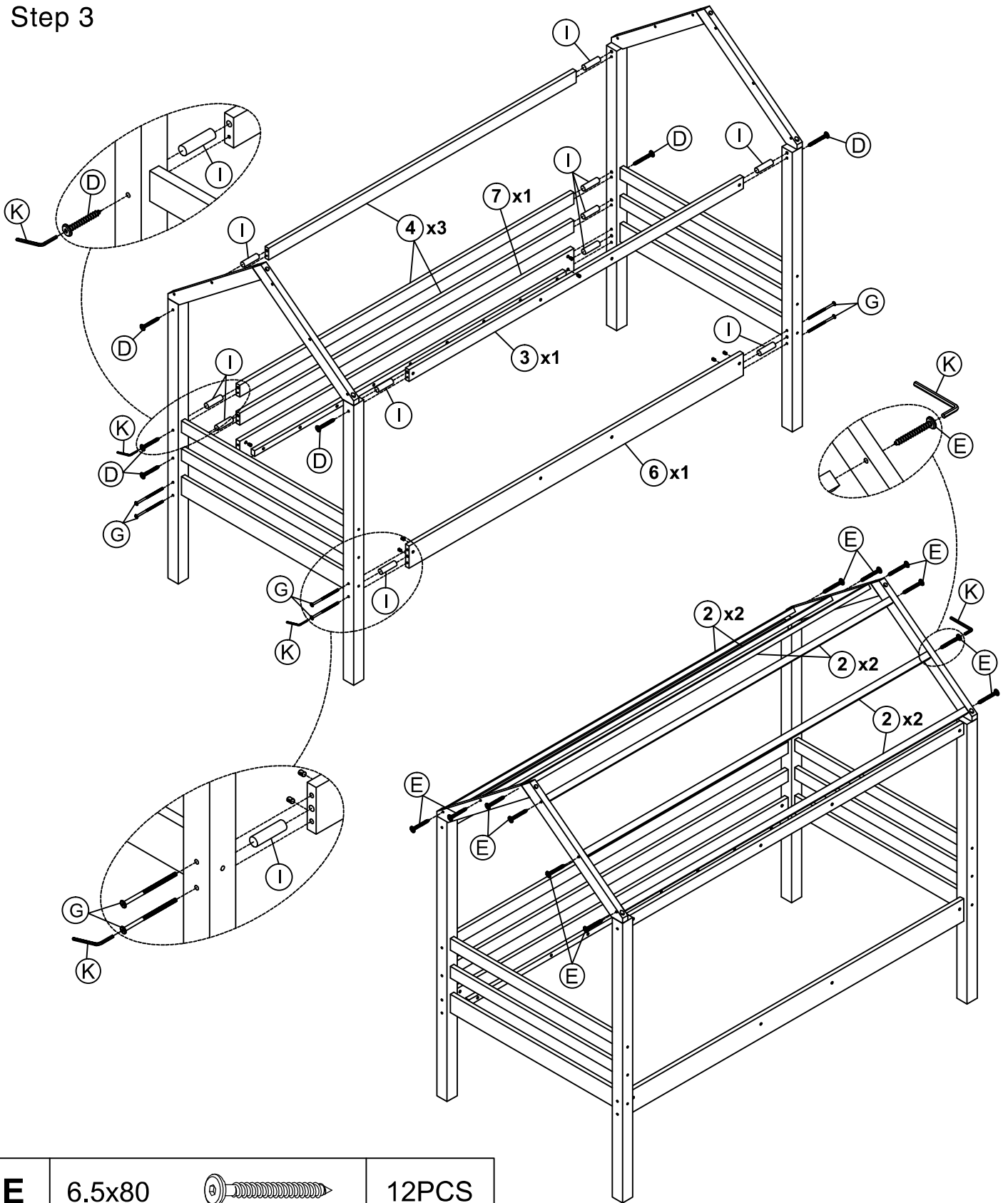

I	Ø10x40		4PCS	K	4x58		1PC
				F	6.5x60		4PCS

ASSEMBLY INSTRUCTIONS

Step 3





E	6.5x80		12PCS				
D	6.5x100		8PCS	K	4x58		1PC
I	Ø10x40		12PCS	G	1/4x110		8PCS

ASSEMBLY INSTRUCTIONS

Step 4

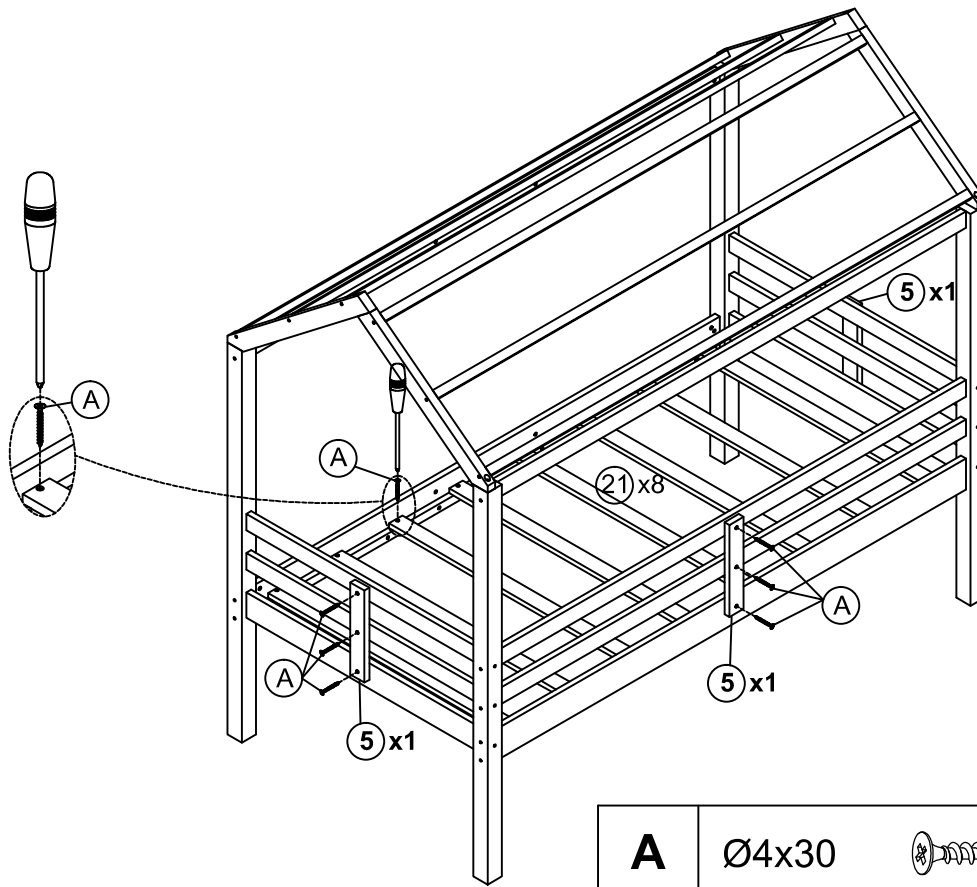

First attach 2pcs part 21 to the front and end of the frame between headboard. Then attach the remaining part 21 equidistantly between headboard

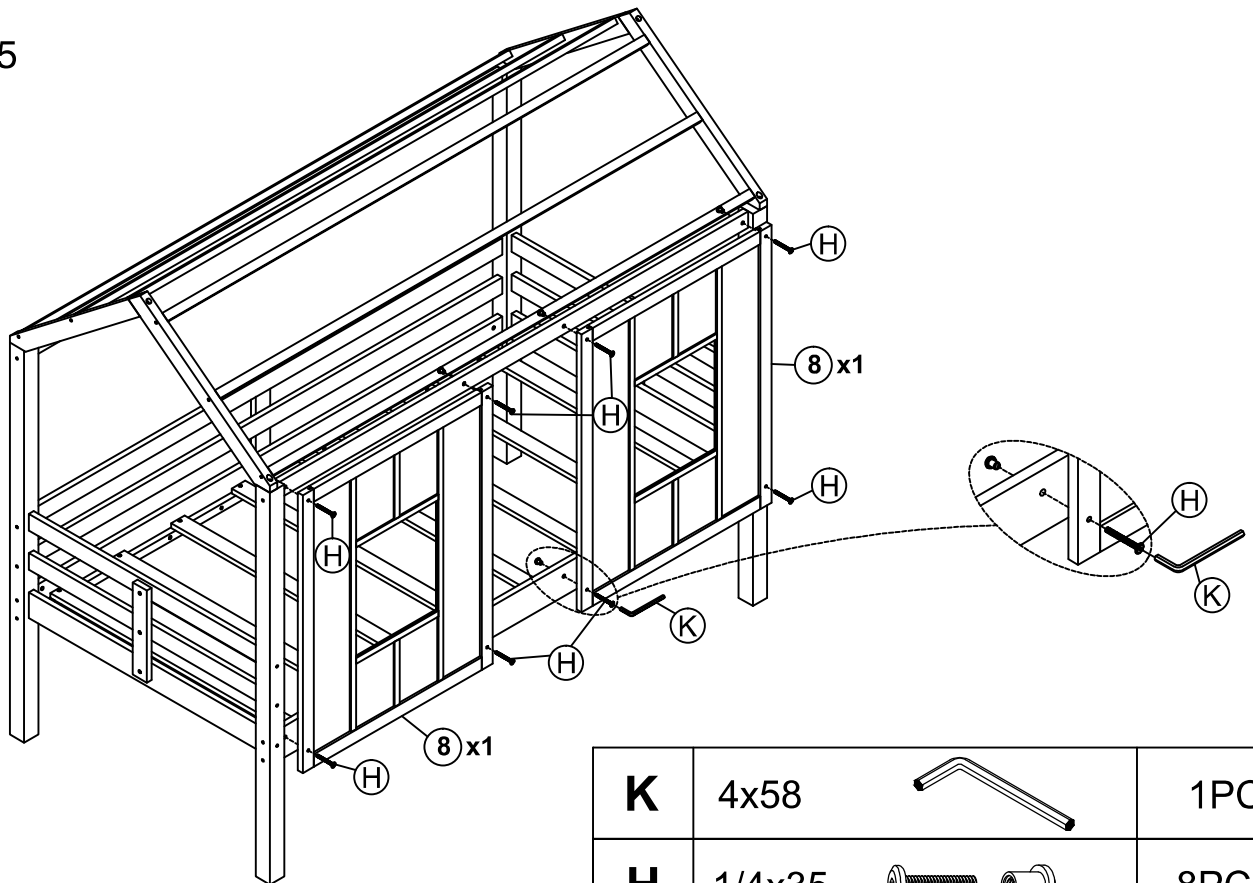

A	Ø4x30		25PCS
----------	-------	---	-------

Step 5





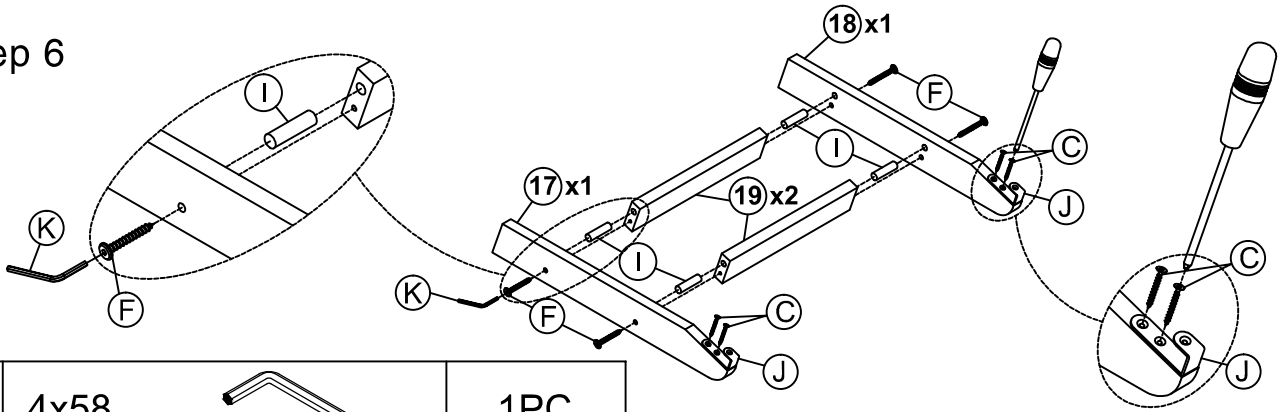

K	4x58		1PC
H	1/4x35		8PCS

ASSEMBLY INSTRUCTIONS



Step 6

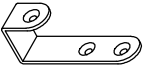

K	4x58		1PC				
F	6.5x60		4PCS	C	Ø4x15		4PCS
I	Ø10x40		4PCS	J	70x18x2		2PCS

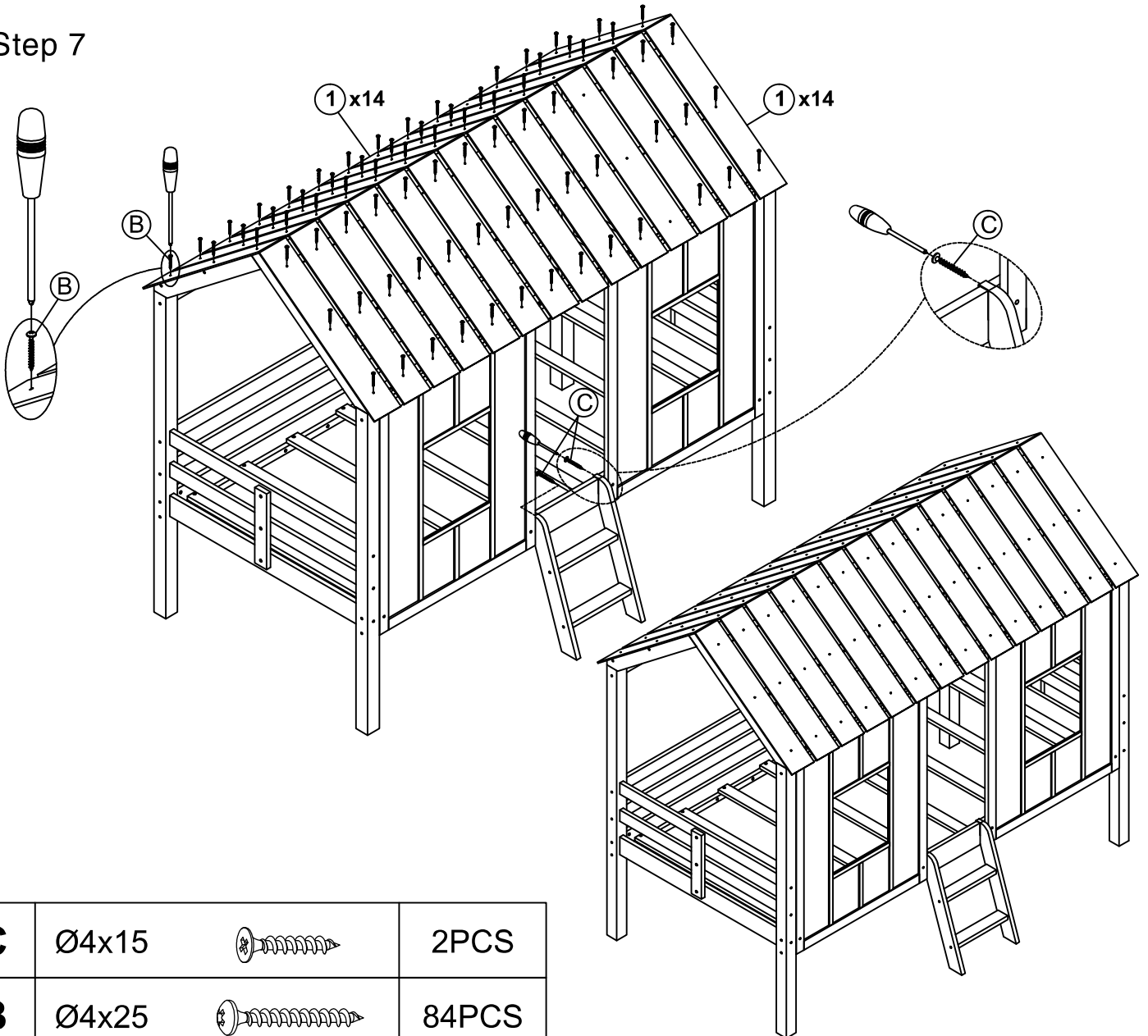
Step 7



C	Ø4x15		2PCS
B	Ø4x25		84PCS