

# Natural Stone Mirror Installation Guide



**CAUTION FRAGILE**

**Please Move the Mirror Carefully.**

**Read all Instructions Prior to Installation.  
Professional Installation Required.**



## WARNING!

# Important Safety Information

## Read Before Installing

- To reduce the risk of injury, this product must be installed by a professional or an individual experienced in mirror installation familiar with structural and safety requirements
- Do **NOT** attempt to lift or carry a large glass mirror panel alone. To prevent injury or damage, always use assistance from a partner or team.
- Always wear appropriate personal protective equipment (PPE), including safety glasses and gloves
- Always handle the mirror with extreme care, especially the edges and corners, as even small impacts can compromise integrity and potentially cause breakage.
- The safety of the installation is the sole responsibility of the installer.

## Mirror & Mounting Safety Warning

Unlike tempered shower glass which breaks into small pieces, standard mirror glass is often annealed (regular) glass which can form large, sharp shards if shattered.

- Do **NOT** install or use any mirror that has chipped corners, slivered edges, or visible damage, or that has been dropped.
- Ensure the wall surface is clean, flat, and sturdy enough to support the mirror's weight.
- Always mount panel-supporting hardware (clips, J-channels, French cleats, etc.) to studs whenever possible for maximum support.
- If studs aren't available, use heavy-duty anchors or toggle bolts specifically rated for the mirror's weight and your wall type (e.g., drywall, concrete).

If damage is suspected, discontinue use immediately and contact us or a qualified glass professional.

## Safety & Maintenance

 **WARNING:** To reduce risk of injury or death:





- Read and follow all installation instructions.
- Do **NOT** lean or push against the glass mirror at any time.
- Do **NOT** allow children to play with, hang from, or slam the mirror.
- Inspect all glass and hardware regularly for signs of loosening, corrosion, or misalignment. Tighten or replace as necessary.
- Use only pH-neutral cleaners specifically designed for natural stone or mild, non-abrasive dish soap and warm water.
- Strictly avoid vinegar, lemon juice, ammonia, bleach, or harsh chemicals. These will damage the mirror's silvered backing and permanently etch the Natural Stone frame

## Risk of Injury or Death

***We assumes no responsibility for injury or property damage resulting from:***

- Improper installation or modification of components
- Failure to follow the instructions provided
- Installation of mirrors that are chipped, cracked, misaligned, or otherwise damaged. Even minor edge damage can lead to spontaneous glass failure or shattering.
- Neglect or improper maintenance
- Exposure to standing water, high humidity environments without proper ventilation, or the use of corrosive cleaning agents that attack the mirror's protective coating

### Install Guide Legend

 <b>DANGER</b>	Indicates a hazardous situation that, if not avoided, will result in death or serious injury.
 <b>WARNING</b>	Indicates a hazardous situation that, if not avoided, could result in death or serious injury.
 <b>CAUTION</b>	Indicates a hazardous situation that, if not avoided, could result in minor or moderate injury.
<b>NOTICE</b>	Indicates practices not related to personal injury.
	Indicates recommended practice / correct method.
	Indicates not recommended practice / incorrect method.

*\*All drawings in this installation manual are for illustrative purposes only and are not drawn to scale.*

# What is Included in Your Install Kit

## Box 1

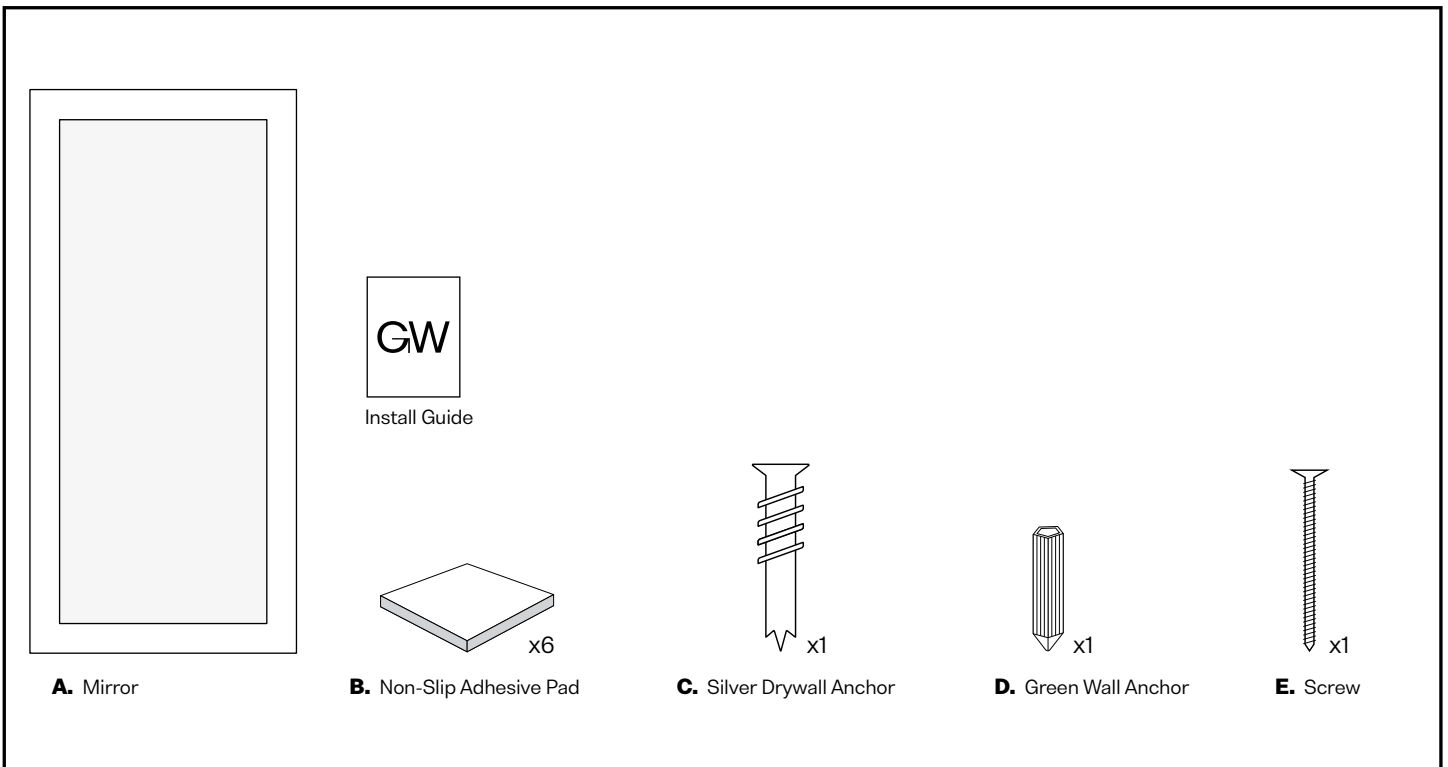

# Installation Tools

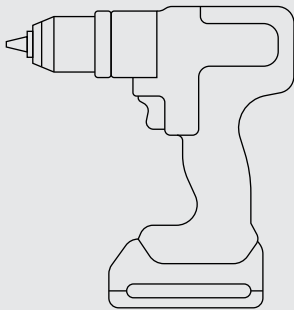

**T1.** Drill



**T2.** ¼" Drill Bit



**T3.** ⅛" Drill Bit

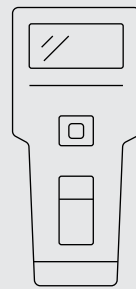

**T4.** Stud Finder



**T5.** Pencil



**T6.** Phillips Head Screwdriver



**T7.** Utility Knife



**T8.** Level

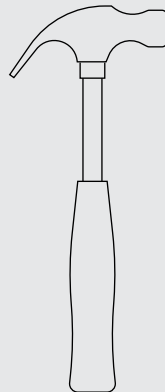

**T9.** Hammer

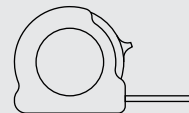

**T10.** Measuring Tape

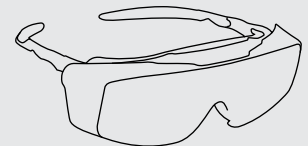

Safety Goggles

# Product Overview

This manual applies to the following products:

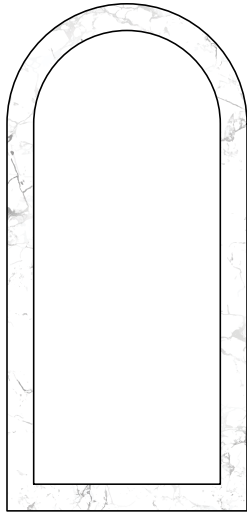

**Zehra**  
Natural Stone Arch Framed Mirror  
MM-ARC

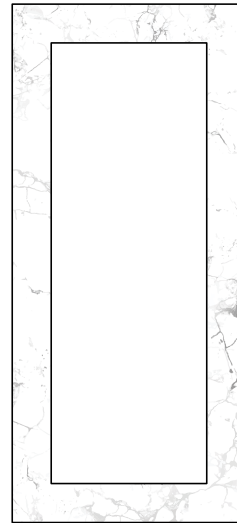

**Suna**  
Natural Stone Rectangular Framed Mirror  
MM-SQ

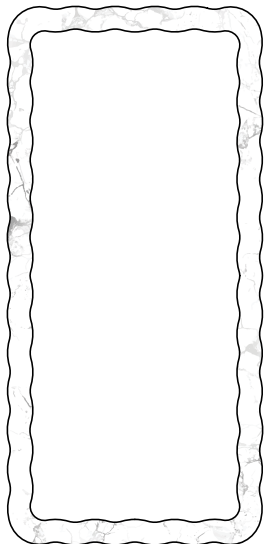

**Miray**  
Natural Stone Scallop Framed Mirror  
MM-SW1

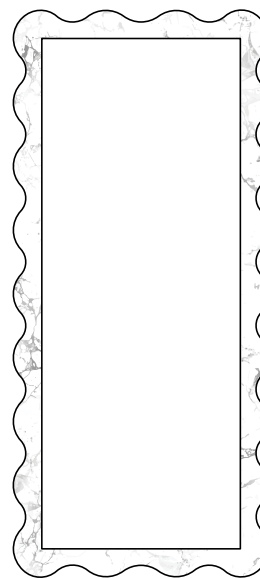

**Deniz**  
Natural Stone Scallop Framed Mirror  
MM-SW2

## ⚠ WARNING

**Lift Large Mirrors with Two People:** Large Mirrors are heavy. Always lift, carry, and position with two people. Failure to do so can result in damage to the Mirror, serious injury, or death.

## NOTICE

**Keep Area Clear:** Keep the area clear of traffic or accidental bumps immediately after installation.

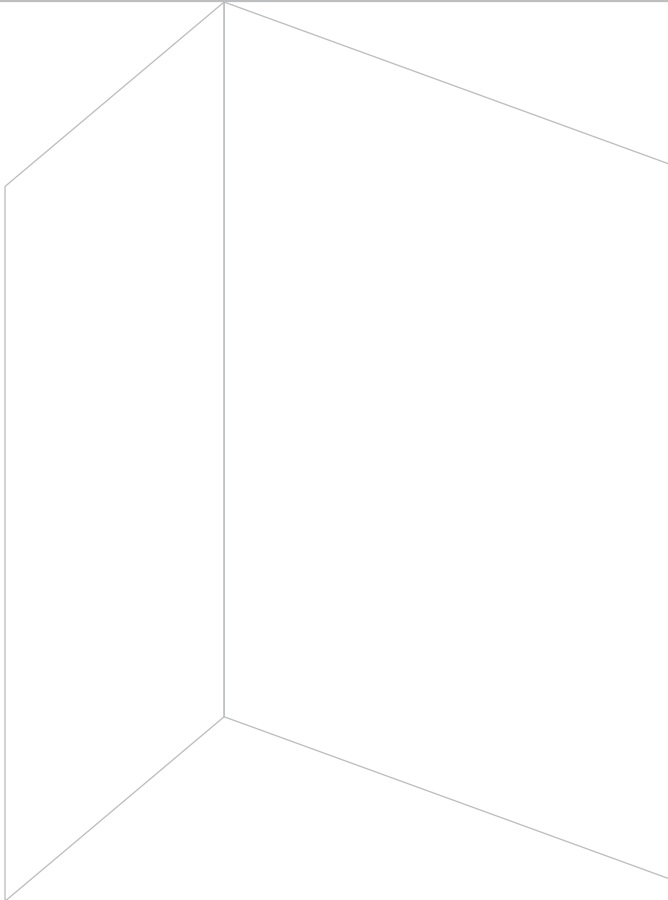

## NOTICE

**Stabilize Mirror with Adhesive Pads:** Non-Slip Adhesive Pads prevent the Mirror from sliding and help stabilize it during installation.

**Tip:** If necessary, the extra non-slip adhesive pads included in your kit can be used as shims to level the mirror and ensure it sits flush against the floor.

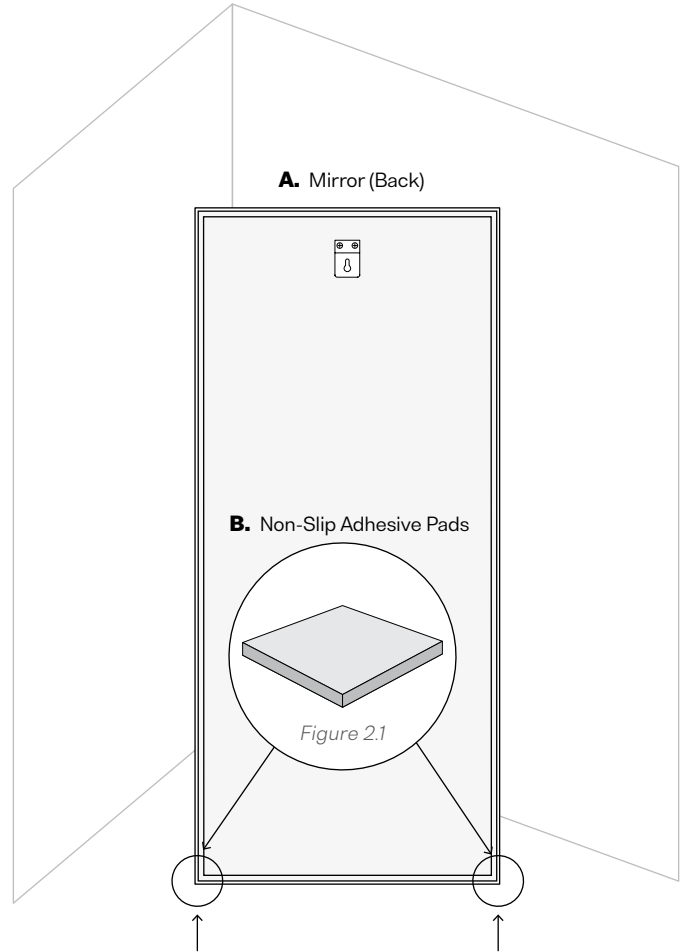

01

### Prepare the installation area

- Clear the floor and wall where the Mirror (**A.**) will be placed. Ensure surfaces are level, clean, and free of dust, debris, or obstructions.
- Verify the floor or threshold is stable and flat to prevent the Mirror (**A.**) from sliding.
- Keep children, pets, and unnecessary personnel away from the installation area.

02

### Attach non-slip Adhesive pads

- Apply the Non-Slip Pads (**B.**) to the bottom edge of the Mirror Frame (**A.**) so they sit between the frame and the floor (Fig. 2.1).
- Press firmly to ensure the Non-Slip Adhesive Pads (**B.**) adhere securely.

## WARNING

**Secure Mirror Base:** Ensure bottom edge of the Mirror is firmly against the floor and cannot slip. Leaning the Mirror without proper support can cause it to tip, resulting in Mirror damage.

## NOTICE

Ensure the mirror remains firmly against the floor while marking to maintain accurate placement

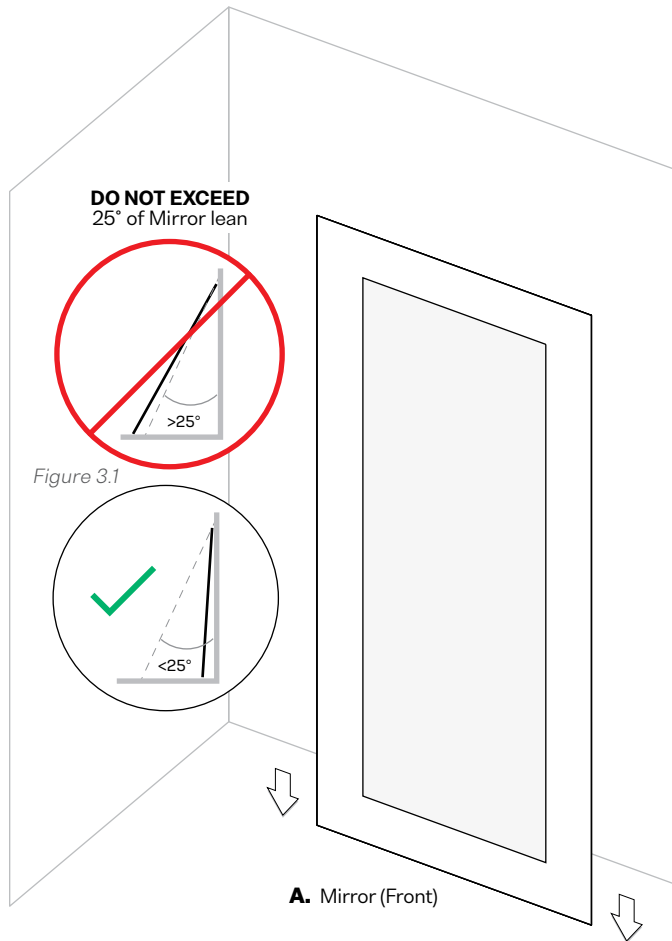

03

### Measure and confirm placement

- Decide the angle at which you will lean the Mirror (**A.**) against the wall. **Do not exceed 25 degrees** (Fig. 3.1).
- Ensure the bottom edge of the Mirror (**A.**) is firmly against the floor and cannot slip.

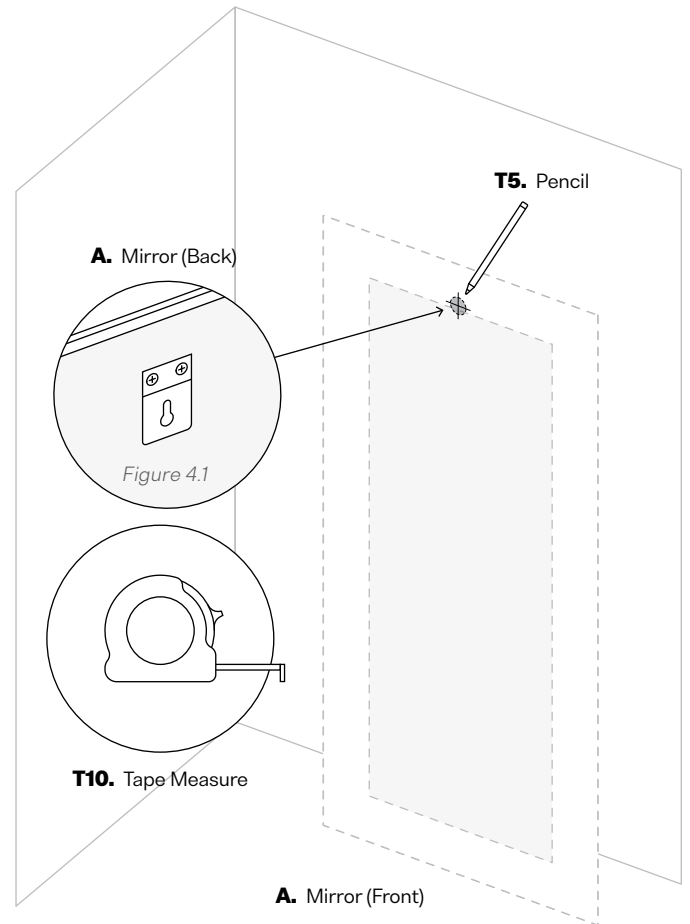

04

### Locate wall fixing point using Anti-tip Plate

- Identify the pre-installed Anti-tip Locking Plate on the back of the Mirror (**A.**) (Fig. 4.1).
- With one person holding the Mirror (**A.**) at the desired angle, have a second person mark the wall at the Anti-tip Plate fixing hole location.
- Confirm the mark is at the correct height before proceeding.

## WARNING

**Use Correct Drill Bits and Anchors:** Using incorrect drill bits or anchors may cause the mounting hardware to loosen over time, potentially resulting in the mirror falling and sustaining irreparable damage.

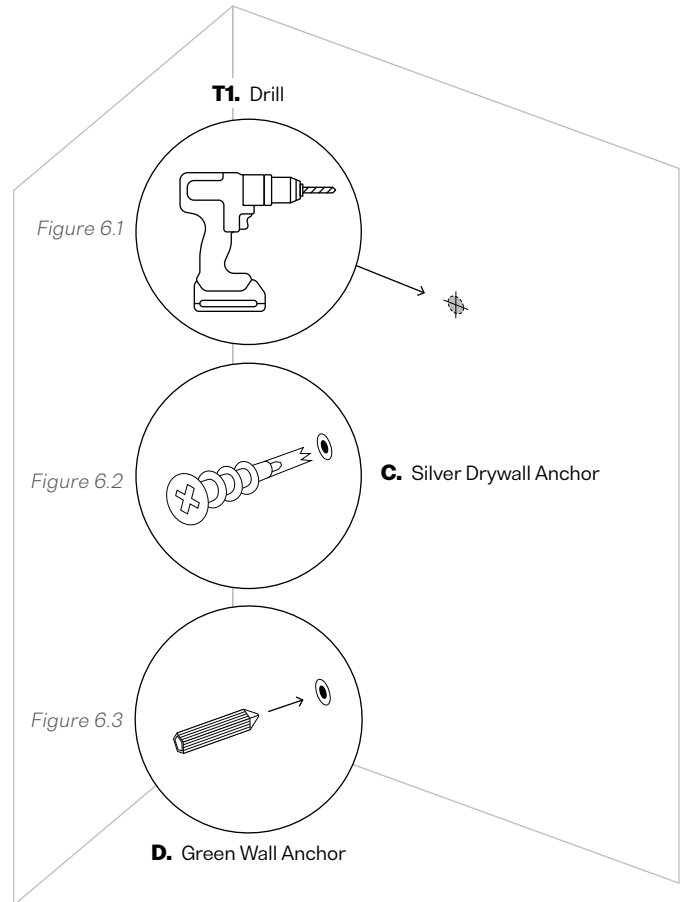
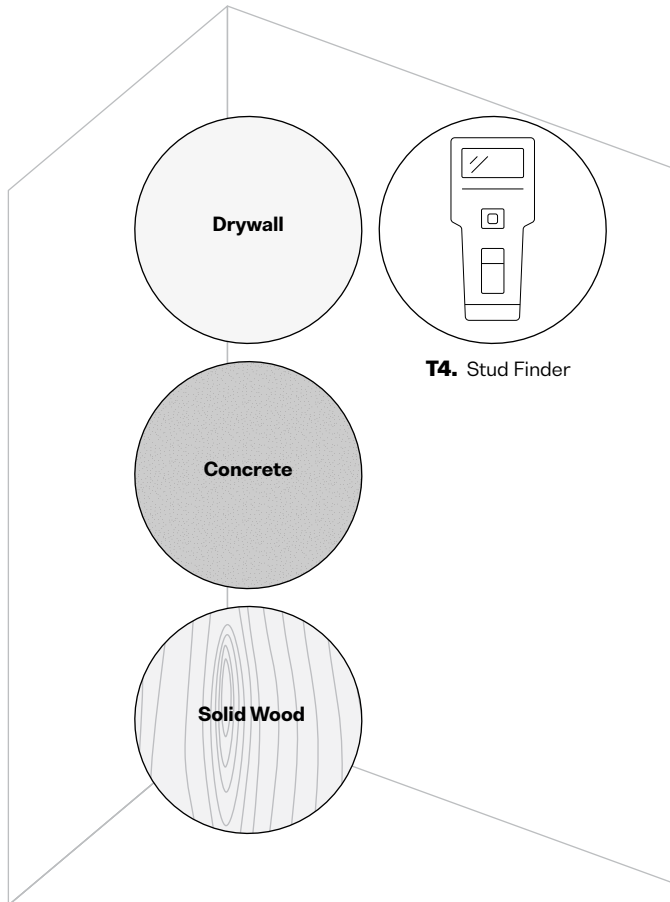

05

### Identify wall surface type

- Inspect the wall at your marked location to determine if it is **drywall**, **concrete** or **solid wood**.
- If working with **drywall**, use a Stud Finder (**T4.**) to determine if the fixing point aligns with a wooden stud or a hollow cavity. For a hollow cavity, **go to step 6a**. If the fixing point aligns with a wooden stud **go to step 6e**.
- For **concrete go to step 6c**, for **solid wood go to step 6e**.

06

### Drill installation holes

#### Drywall:

- Using a (**T2. ¼" Drill Bit**) drill a ¼" (**7 mm**) pilot hole at the marked location (Fig. 6.1).
- Gently screw the Silver Drywall Anchor (**C.**) into the hole until it is flush with the wall surface (Fig. 6.2).

#### Concrete Wall:

- Using a (**T2. ¼" Drill Bit**) drill a ¼" (**7 mm**) pilot hole at the marked location.
- Gently tap the Green Wall Anchor (**D.**) into the hole until flush with the wall (Fig. 6.3).

#### Solid Wood Wall or Stud:

- Using a (**T3. ½" Drill Bit**) drill a ½" (**3 mm**) pilot hole at the marked location (Fig. 6.1).
- Wall anchors are not required; the screw (**E.**) will fasten directly into the wood.

**⚠ WARNING**

**Secure Screws and Anchors:** Unstable screws or anchors can allow the mirror to tip, resulting in significant damage to the mirror and surrounding property.

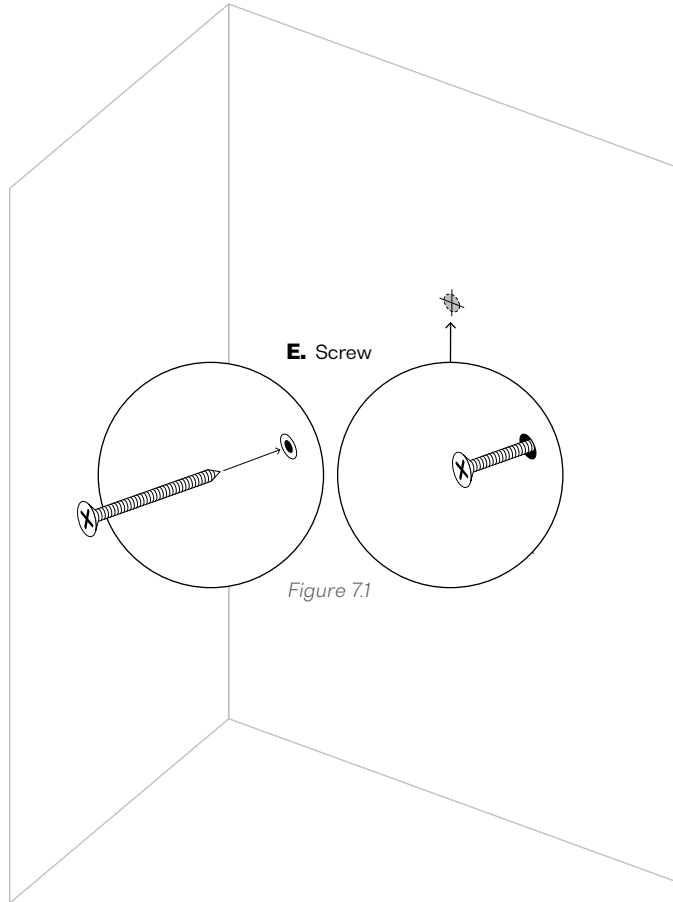

07

**Insert screws**

- a. Thread a Screw (**E.**) into either the anchor or pilot hole until the screw head protrudes approximately  $\frac{1}{4}$ " (**7 mm**) from the wall (Fig. 7.1).
- b. Test each fixing by pulling outward and downward to ensure the Screw and Anchor are secure.

**⚠ WARNING**

**Avoid Over-Bending Plates:** To ensure maximum stability, do not over-bend the plates; excessive bending permanently weakens the hardware and may result in the mirror detaching from the wall.

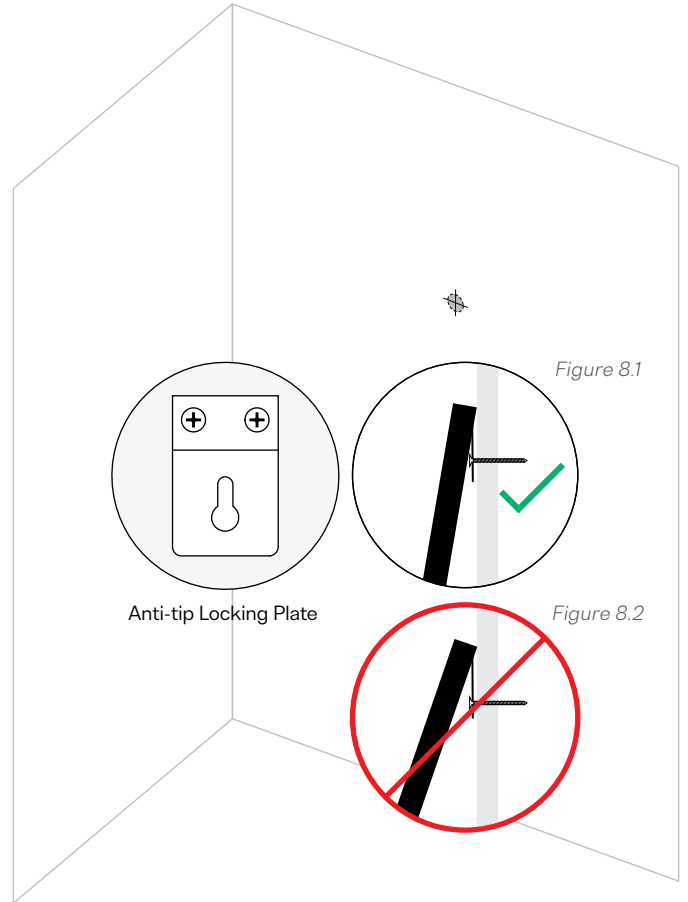

08

**Adjust Anti-tip Locking Plate**

- a. If necessary, lightly bend the Anti-tip Locking Plate to align perfectly with the Wall (Fig. 8.1).
- b. **Do not over-bend** - the plate must maintain its structural integrity (Fig. 8.2).

## WARNING

**Tip-over hazard:** Failure to properly secure the Anti-Tip Plate may result in serious injury or death. Ensure the Anti-Tip Plate is fully engaged with the screw. Friction and gravity are not sufficient anchors.

## NOTICE

**Check Screws Periodically:** For extra stability, check the Mirror after a few hours and periodically over time to ensure the screws remain secure.

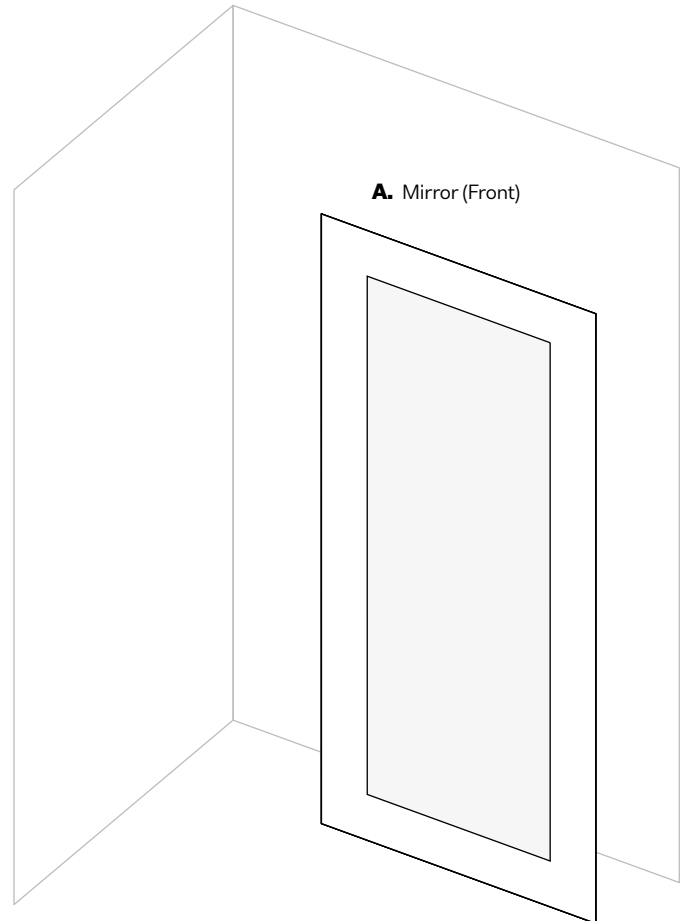
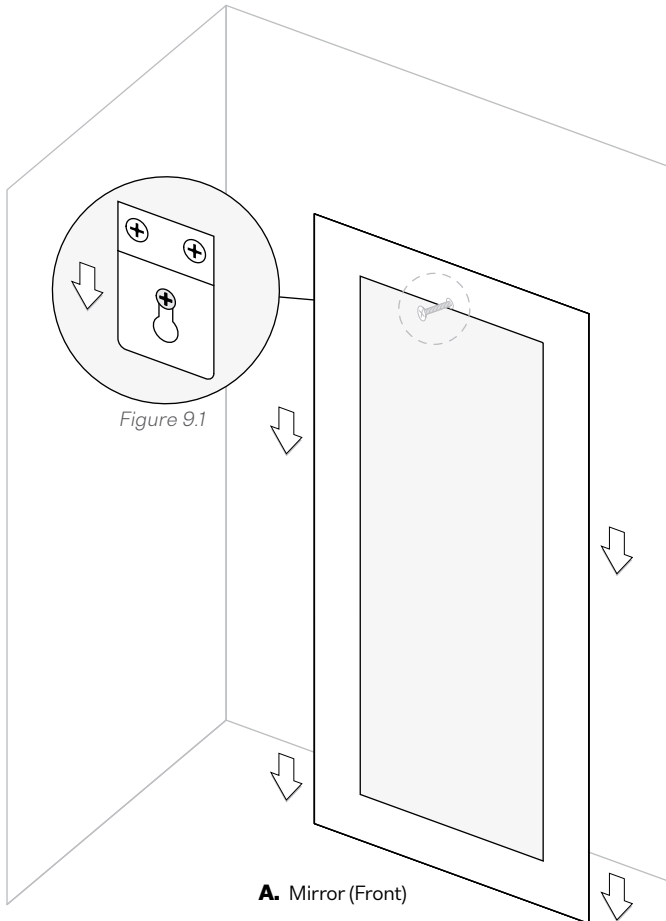

09

### Secure Mirror to wall

- With the help of a second person, lift the Mirror (A.) and position the Anti-tip Plate over the protruding wall screw (E.).
- Slide or hook the plate onto the screw (E.) so the Mirror (A.) sits securely against the wall (Fig. 9.1).

10

### Final fastening & floor clearance

- Verify Mirror (A.) is securely engaged with the mounting hardware.
- Perform a final check to ensure nothing (debris, rugs, tools) is beneath or behind the Mirror (A.) that could cause shifting or instability.

## NOTICE

**Keep Installation Area Clear:** Keep the area clear of traffic or accidental bumps immediately after installation.

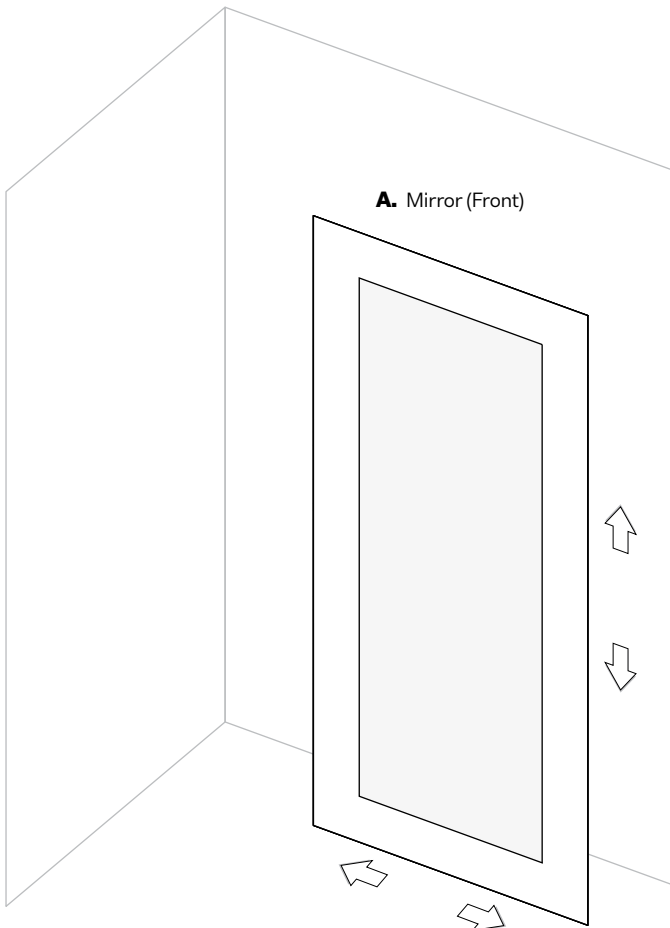

11

### Stability & alignment audit

- Confirm the bottom edge of the Mirror (**A.**) sits flush on the floor.
- Verify stability by ensuring the mirror cannot tip forward or shift laterally and does not wobble when gently tapped on the top corners.
- Once confirmed, wipe the edges and surface to remove fingerprints or debris.

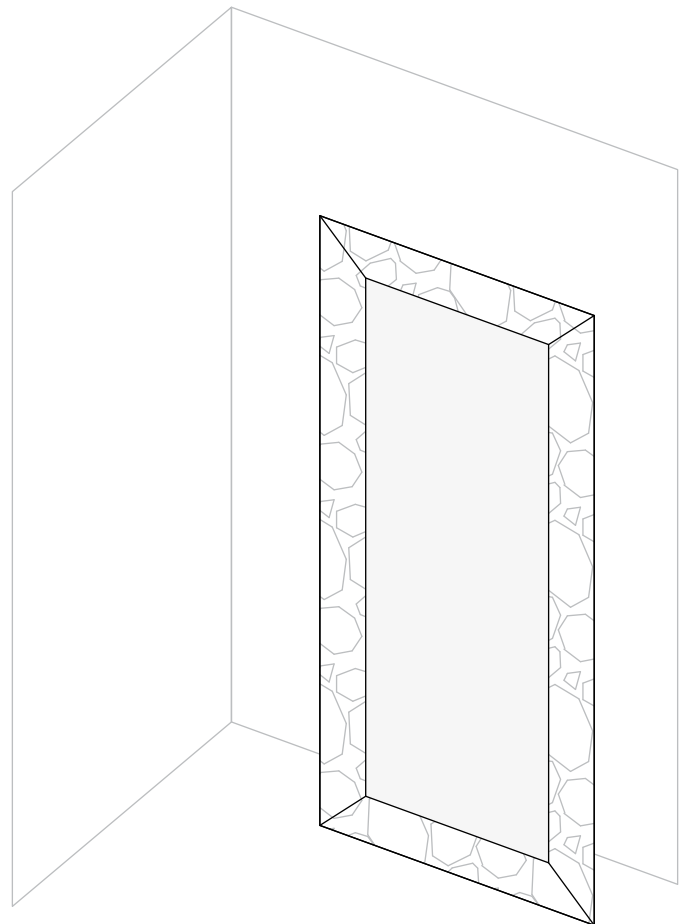

12

**Congratulations—  
your mirror is installed and ready to enjoy!**

# Thank You for Your Purchase.

If you experience difficulties with your installation, please contact **us** directly rather than returning the product to the place of purchase. Returns should only be made if the mirror arrives damaged. If any components are missing, our team can promptly provide replacement parts and offer installation guidance to support the successful completion of your project.

**We are** dedicated to providing exceptional quality and attentive customer support. Our mirror collection features a wide range of sizes and styles, ensuring that no matter your measurements or design goals, we can help you find the ideal match for your space.

If you have any questions, please do not hesitate to reach out to us. Thank you again for choosing **us**!

Best Regards,

# Cleaning & Maintenance

Our Natural Stone Mirrors are crafted from natural stone and require proper care to maintain their appearance and longevity. Following these guidelines will help protect both the Natural Stone frame and mirror glass.

## Natural Stone Frame Care

### Maintenance

Wipe up spills immediately using a clean, soft cloth to prevent staining, as natural stone is a porous material.

Avoid placing sharp or abrasive objects against the frame to prevent scratching.

This product is intended for indoor use only. Avoid prolonged exposure to direct sunlight and high-humidity environments, as these conditions can affect the stone over time.

### Cleaning

Use only pH-neutral cleaners specifically formulated for natural stone, or a mild dish soap diluted with warm water. Before using any new cleaner, test on a small corner of the Natural Stone frame to confirm compatibility and avoid potential damage.

### Recommended options:

- StoneTech Daily Cleaner
- Granite Gold Daily Cleaner
- Method Daily Granite Cleaner

## Mirror Glass Care

### Cleaning Application

Always apply glass cleaner to a soft, lint-free cloth rather than spraying directly onto the mirror. This helps prevent liquid from seeping into the edges, which can damage the backing.

### Recommended glass cleaners:

- Sprayway Glass Cleaner
- Invisible Glass Cleaner

Avoid excessive moisture near the edges of the mirror.

### Drying

Dry the glass and frame edges immediately after cleaning to remove any residual moisture and reduce the risk of edge corrosion.

### Placement & Handling

Ensure the mirror is placed on a clean, flat surface free of debris or moisture that could cause shifting or damage.

Avoid placing the mirror in areas with consistently high humidity (such as directly next to showers), as prolonged exposure may affect both the Natural Stone and mirror backing.



First, We Brought the World  
High-Quality Affordable Glass  
Shower Doors & Enclosures.

Now, Our Expanding Line of  
Products Includes Glass Railing  
Solutions, Mirrors, Medicine  
Cabinets and More.

# Exclusive Limited Warranty Terms & Conditions.

This Limited Lifetime Warranty ("Warranty") is effective as of APRIL 6, 2026

**PLEASE READ THE WARRANTY TERMS AND CONDITIONS BEFORE PURCHASING AND BEFORE INSTALLING OR RESELLING YOUR PRODUCT. BY PURCHASE, INSTALLING, AND OR RESELLING THE PRODUCT, YOU ARE CONSENTING TO BE BOUND BY THE FOLLOWING TERMS AND CONDITIONS.**

We provide this Warranty to the business or individual ("Buyer") who purchases a product ("Product") directly from us or from an authorized reseller, including without limitation, shower kits, railing hardware, medicine cabinets, and mirrors. If Buyer is a licensed and fully insured professional and installs the Product in the residence of one of Buyer's customers ("Customer"), Buyer may pass this Warranty through to such Customer. In each case, this Warranty shall extend only to the original Buyer or Customer at the time of installation and shall expire if the original Buyer or Customer no longer owns or occupies the residence at which the Product is first installed. This Warranty will not apply to any subsequent owners or occupants of the residence. "Products" do not include, and this Warranty specifically excludes: (i) any products sold under other brand names; (ii) any third-party products distributed or sold by us that are not incorporated into our Product.

## **Limited Lifetime Warranty for Glass**

With respect to any glass components of the Product, Seller warrants to Buyer that for the lifetime of the Product ("Glass Warranty Period"), that such components (excluding seals) will materially conform to Seller's published specifications and will be free from material defects in material and workmanship. Warranty for any part in oil rubbed bronze or matte black finish shall be limited to one (1) year. With respect to any Product used in commercial, industrial, or non-residential uses, including without limitation hotels, casinos, and apartments, the Glass Warranty Period is one (1) year. For mirrors, including medicine cabinets with mirrors, the Glass Warranty Period is one (1) year. For glass railings, the Glass Warranty Period is three (3) years. The Glass Warranty Period with respect to the outer coating of any glass component, such as an Enduroshield coating, is five (5) years.

## **Limited 5-Year Warranty for Hardware**

With respect to any hardware components of the Product, Seller warrants to Buyer that for a period of five (5) years from the date of Buyer's purchase of the Product ("Hardware Warranty Period"), that such components (excluding seals) will materially conform to Seller's published specifications and will be free from material

defects in material and workmanship. With respect to any Product used in commercial, industrial, or non-residential uses, including without limitation hotels, casinos, and apartments, the Hardware Warranty Period is one (1) year. For mirrors, including medicine cabinets with mirrors, the Hardware Warranty Period is one (1) year. For railings, the Hardware Warranty Period is one (1) year. The Glass Warranty Period and Hardware Warranty Period are referred to together as the "Warranty Period."

While stainless steel is resistant to corrosion, it is not corrosion or rust-proof. Environmental conditions including, but not limited to, exposure to chemicals, salt air, pollution, and high humidity may cause surface discoloration or rust. Regular cleaning and maintenance is required to maintain the appearance and integrity of stainless steel products. Seller makes no warranty against and shall not be liable for any claims related to surface rust, discoloration, or corrosion of stainless steel components.

## **Warranty Terms and Conditions**

This Warranty shall be voided if the Product (i) has been subjected to abuse, misuse, neglect, negligence, accident, improper testing, improper installation, improper cleaning (such as use of abrasive cleaners), improper storage, improper handling, abnormal physical stress, abnormal environmental conditions, or use or installation contrary to any instructions or guidelines issued by us; (ii) has been altered, repaired, or reconstructed by anyone other than us; (iii) was installed by anyone other than a fully insured and licensed professional; (iv) was not installed according to our published installation instructions or guidelines; (v) is installed or used outside of the US or Canada; or (vi) has been used with any third-party hardware or product that has not been previously approved in writing by us. This Warranty shall not apply to normal wear and tear. With respect to Products advertised by us for outdoor use, this Warranty specifically excludes damage caused by extreme weather events.

**WARNING: INSTALLATION OF GLASS PRODUCTS (I.E., SHOWER AND TUB DOORS) BY AN UNLICENSED OR INEXPERIENCED INSTALLER MAY RESULT IN GLASS BREAKAGE, DAMAGE TO PROPERTY, SERIOUS INJURY OR DEATH.**

Neither Buyer, nor any other person is permitted to make any affirmation, representation, or warranty other than those contained in this Warranty. Any affirmation, representation, or warranty other than those contained in this Warranty shall not be enforceable against Seller or any other person. Seller reserves the right to modify this Warranty at any time, it being understood that such modifications will not alter the terms and conditions applicable at the time of sale of the products in question.

### **Claims Process and Remedies:**

All Warranty claims are subject to review and confirmation by Seller, and Seller reserves the right to inspect the installation to confirm the validity of the Warranty claim. To submit a Warranty claim, Buyer must:

1. Contact Seller's customer service department within 30 days of discovering the defect.
2. Provide the following required documentation: (a) proof of purchase; (b) detailed description of the defect, including photographs; (c) item part number.
3. A customer service representative will review the claim and may request additional information or schedule an inspection of the Product and/or installation. Buyer must cooperate fully with any requests for information or inspection.

Seller shall have no obligation to honor any Warranty claim that does not comply with the above claims process. If a Warranty claim is approved, Seller shall, in its sole discretion, either: (i) repair or replace such Product (or the defective part), in which case Seller shall cover shipping of the repair parts or replacement product; or (ii) refund the price paid by Buyer to Seller for such Product. Replacement parts and products will be covered by this Warranty for the remainder of the Warranty Period of the original Product. Seller may require that the Product be returned to Seller, at Seller's expense. Except for any repairs made by Seller or its representatives as set forth above, Seller shall not pay for labor related to the Warranty claim, such as removal of the defective Product or installation of a replacement product. Seller's warranty obligation shall be discharged upon tender of parts, replacement or repair of the Product. Buyer's refusal to accept the tender terminates all warranty obligations and **VOIDS THIS WARRANTY.**

**THE REMEDIES SET FORTH ABOVE SHALL BE BUYER'S SOLE AND EXCLUSIVE REMEDY AND SELLER'S ENTIRE LIABILITY FOR ANY BREACH OF THIS WARRANTY.**

### **Disclaimer and Limitation of Liability:**

**EXCEPT FOR THE PRECEDING WARRANTY, SELLER MAKES NO WARRANTY TO BUYER WHATSOEVER WITH RESPECT TO THE PRODUCTS AND HEREBY DISCLAIMS ALL OTHER WARRANTIES, INCLUDING ANY (I) WARRANTY**

**OF MERCHANTABILITY; (II) WARRANTY OF FITNESS FOR A PARTICULAR PURPOSE; OR (III) WARRANTY AGAINST INFRINGEMENT OF INTELLECTUAL PROPERTY RIGHTS OF A THIRD PARTY; WHETHER EXPRESS OR IMPLIED BY LAW, COURSE OF DEALING, COURSE OF PERFORMANCE, USAGE OF TRADE OR OTHERWISE.**

**SELLER DISCLAIMS AND SHALL NOT BE LIABLE FOR ANY PERSONAL INJURIES OR DEATH TO ANY PERSON, INCIDENTAL DAMAGES, CONSEQUENTIAL DAMAGES, LOSS OF PROFITS, LOSS OF USE, LABOR OR MATERIAL CHARGES, OR ANY OTHER COSTS RELATING TO THE USE OR INABILITY TO USE THE PRODUCT OR REPLACEMENT PRODUCT OR RELATING TO THE APPLICATION OF THIS WARRANTY. IN NO EVENT SHALL SELLER'S AGGREGATE LIABILITY EXCEED THE PURCHASE PRICE OF THE PRODUCT.**

**SOME STATES LIMIT A MANUFACTURER'S ABILITY TO DISCLAIM CERTAIN WARRANTIES OR LIABILITIES AND THEREFORE SOME OF THE ABOVE DISCLAIMERS OR LIMITATIONS OF LIABILITY MAY NOT APPLY TO YOU.**