

**Boyd Sleep
Padded Beds
"Limited" Warranty**

**Thank you for your recent purchase. Please register your product online today at
www.boydsleep.com/register.**

Model	Full Replacement
Arden, Barcelona, Beaumont, Birmingham, Bree, Carlisle, Central Park, Charlat, Chloe, Cordoba, Darlington, Diamond, Diagonal, Dorset, Florence, Kendal, Leah, Luxembourg, Manchester, Messina, Mia, Milan, Modena, Napoli, New Castle, Parma, Piedmont, Pisa, Ravenna, Roma, Sail Away, Savona, Salerno, Senata, Sicily, St. Ives, Tuscany, Universal Headboard, Valencia, Verona, Zoe	0-12 months

This warranty is between Boyd Sleep and the original purchaser and is valid only when accompanied by the original purchaser's sales receipt showing original date of purchase and location of purchase. Replacements under this warranty revert to the date of original purchase for future warranty. Maintain this warranty document and your sales receipt in a safe place.

Boyd Sleep or its authorized dealer can accept or reject warranty claims based on its findings. This warranty applies in normal residential use only. Normal residential use only is described as using the product on a level surface with all legs touching the floor with an equal distribution of weight. The product is to be used with standard mattresses only. This warranty is invalid if the product is not used for its intended purpose. Boyd Sleep can make substitutions as required of materials, components, and sub-components of comparable value and utility. Boyd Sleep reserves the right to refuse service and invalidate the warranty when, upon inspection, the product failure is caused by factors other than defective workmanship or materials.

Manufacturing defects include when the product has become defective where it will not support the mattress properly.

Sales and use taxes, plus shipping and handling charges are the responsibility of the consumer. Consumer is required to deliver damaged product to the authorized dealer.

Certain items are not covered by this warranty. These include, but are not limited to the following:

1. Components subjected to abuse including abuse intended to simulate failure.
2. Damages caused by shipper, dealer, or installation crew such as scratches, dents, fabric tears etc.
3. Any part which merely exhibits normal wear yet functions essentially as new.
4. Boyd Sleep disclaims liability for any aspect of installation and any inconvenience caused by a defective part of a component.
5. Tears, punctures, dents, or any damage caused by improper installation.
6. Items sold "as is" and Floor Model Units.
7. Boyd Sleep warrants only the products listed at the top of this page. This warranty does not extend to any mattress that may be placed on the listed products.
8. Weight Capacity - King, California King, Queen, Double size - 700 Lbs. Twin size - 400 Lbs.

To make a claim, return the defective part along with your original sales receipt to an authorized Boyd Sleep dealer. If there is not a dealer in your area, send a copy of the original sales receipt, the defective product along with a brief description of the problem to: Boyd Sleep, 2440 Adie Rd., St. Louis, MO, 63043. All items must be sent freight prepaid.

Replacement will be made at the company's option. This is the entire exclusive express limited warranty. The manufacturer neither makes nor is responsible for any other warranties, either expressed or implied, including those of retailing dealers. Any and all liability for breach of warranty, as well as damages for incidental or consequential losses is expressly denied.

**BOYD SLEEP, 2440 ADIE RD, ST. LOUIS, MO 6304
Phone - 314-993-2693**

ASSEMBLY INSTRUCTIONS

STEP 3

Attach the eight 20mm bolts (Part 1) to the headboard leg (Part B) and footboard leg (Part D) using the large hex key (Part 12). Do not tighten.

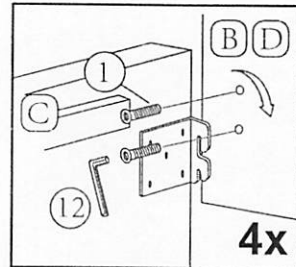
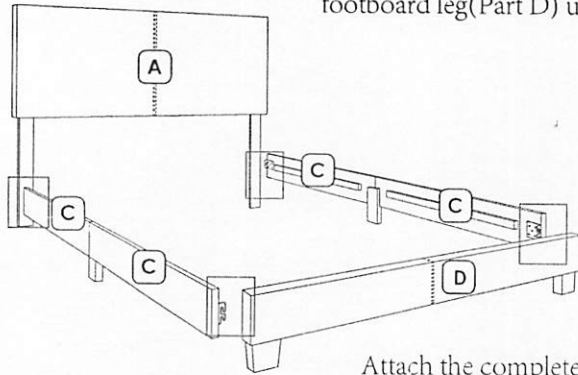

Attach the complete side rail to headboard (Part A) and footboard (Part D) by sliding the side rail brackets onto the bolts on the headboard legs (Part B) and footboard (Part D). Do not tighten yet.

STEP 4

Attach four center leg (Part F) to the slats (Part H) using 40mm bolt (Part 6). Tighten the bolt using small hex key (Part 11). Repeat the step for all four support leg.

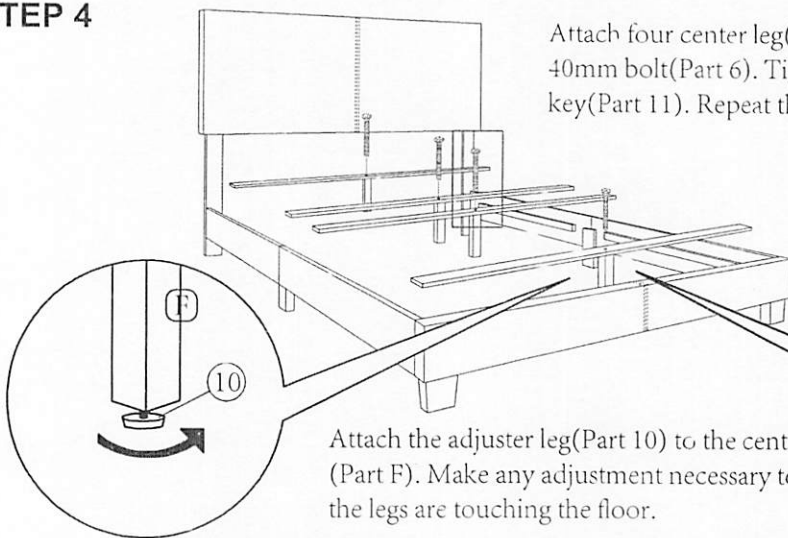

Attach the adjuster leg (Part 10) to the center leg (Part F). Make any adjustment necessary to ensure the legs are touching the floor.

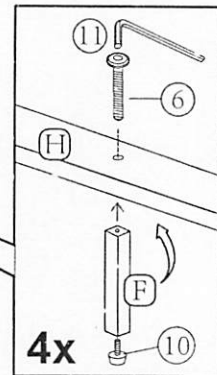

STEP 5

Place the four slats into the bed as shown. Tighten the bolts on the headboard legs and footboard using large hex key (Part 11). Secure the 4 slats using eight screws (Part 9) and a Phillips Screwdriver. Your bed is now set up and ready for use.

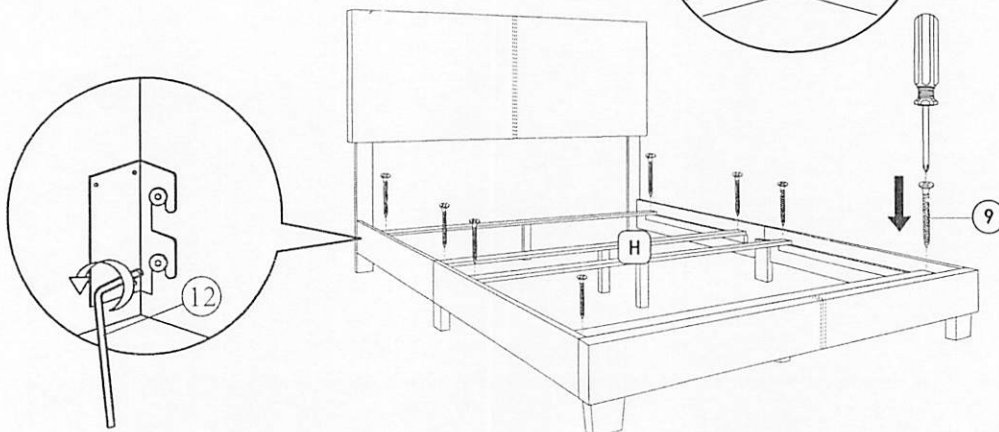
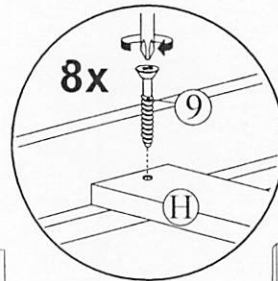

IMPORTANT NOTE:

For customer support please call: 314-993-2693
Carefully remove all the parts from the box. Arrange on a flat surface and verify you have all of the following parts and hardware

TOOLS REQUIRED:
Phillips Screwdriver

PARTS LIST

A. Headboard (1 pc)

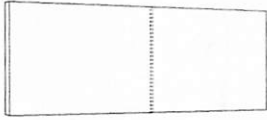

B. Headboard Legs (2 pcs)

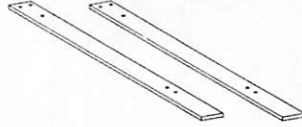

C. Side Rail (4 pcs)



D. Footboard (1 pc)



E. Side Rail Support Leg (2 pcs)

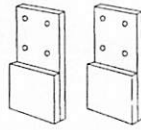

F. Center Leg (4 pcs)

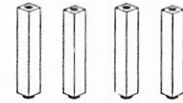

G. Footboard Legs (2 pcs)

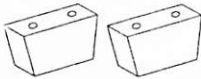

H. Wood Slat (4 pcs)



I. Side Rail Slat Support (4 pcs)

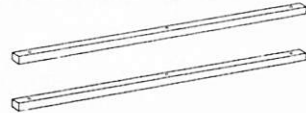

HARDWARE LIST

1. 20mm Bolt (8 pcs)

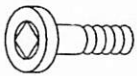

2. Flat Washer (14 pcs)

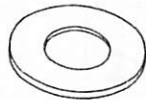

3. Spring Washer (14 pcs)



4. Wood Dowel M8 (4 pcs)

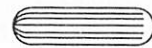

5. 30mm Bolt (20 pcs)

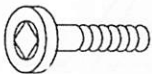

6. 40mm Bolt (4 pcs)

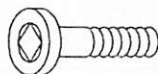

7. 50mm Bolt (6 pcs)

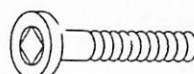

8. 70mm Bolt (2 pcs)

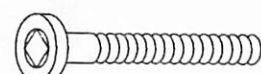

9. 32mm Screw (8 pcs)



10. Adjuster (4 pcs)



11. Small Hex Key (1 pc)



12. Large Hex Key (1 pc)

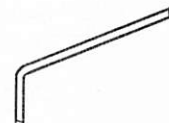

Florence Twin/Double/Queen Bed
Assembly Instruction
Contains One Bed and Hardware

