

# ASSEMBLY INSTRUCTION

## MODEL #BD00461EK1





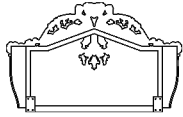
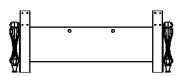

Thank you for purchasing the quality product. Be sure to check all packing material carefully for small parts which may have come loose inside the carton during shipment. Separate, identify and count all parts and metal hardware. Compare with all parts list to be sure all parts are present. If any part(s) are missing or damaged, please contact your local furniture dealer. For efficient and speedy service, please indicate the model number and code letter of part(s) needed.

**\*\*\* Do not fully tighten screws until fully assembled \*\*\***

### PARTS LIST

NO	DESCRIPTION	SKETCH	QTY
A	HEADBOARD		1 Pcs
B	BASE		1 Pcs

### HARDWARE LIST

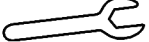
NO	DESCRIPTION	SKETCH	QTY
1	BOLT (Ø5/16*50MM)		8 Pcs
2	FLAT WASHER (Ø5/16*2MM)		8 Pcs
3	ALLEN KEY (M4)		1 Pc
4	SCREW BOLT (Ø5/16*100MM)		2 Pcs
5	TIGHT FIRMWARE		2 Pcs
6	HEXAGON NUT		2 Pc
7	WRENCH		1 Pc

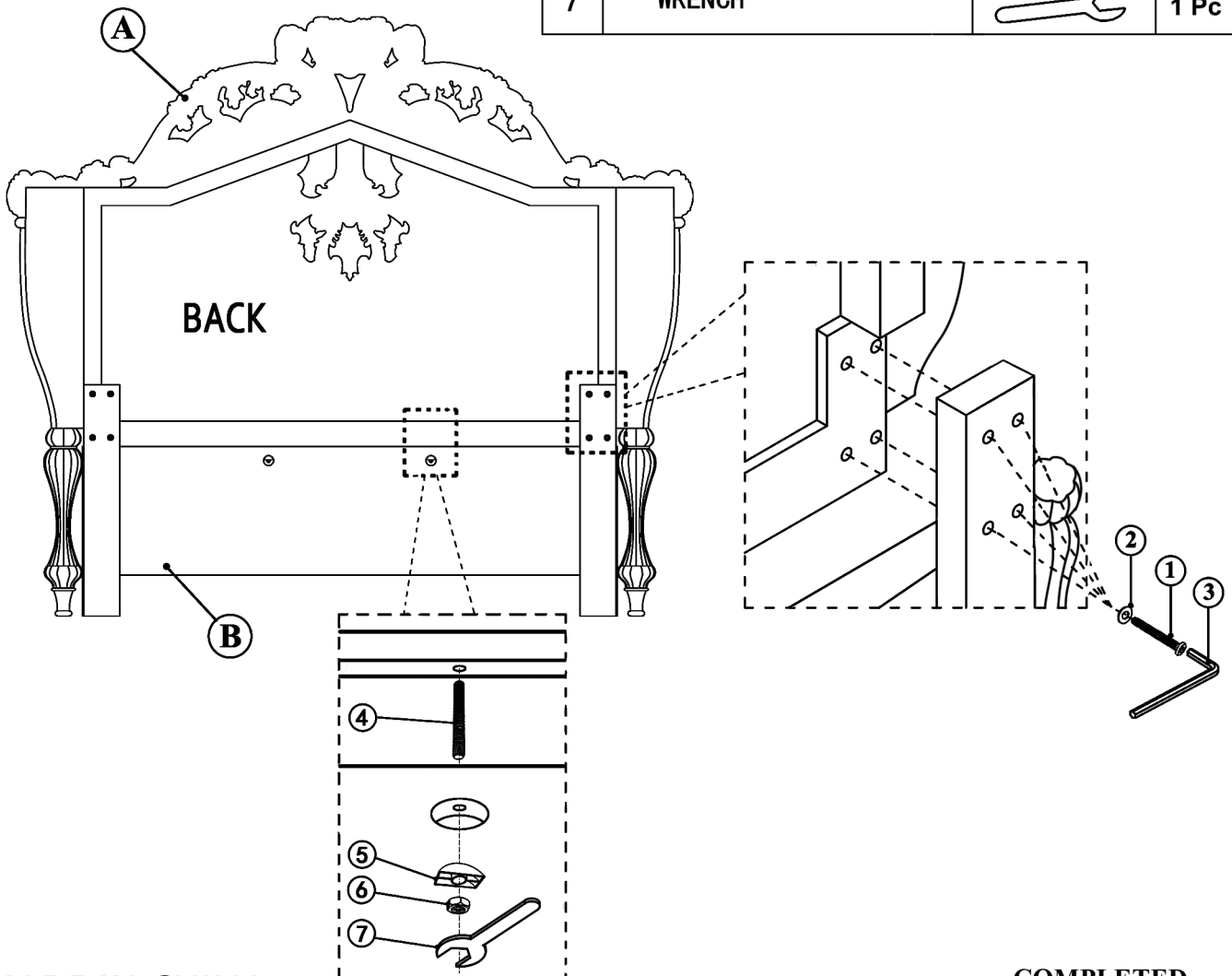

MADE IN CHINA

COMPLETED





# ASSEMBLY INSTRUCTION FOR ACME FURNITURE

## MODEL #BD00461EK



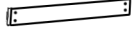

Thank you for purchasing the quality product. Be sure to check all packing material carefully for small parts which may have come loose inside the carton during shipment. Separate, identify and count all parts and metal hardware. Compare with all parts list to be sure all parts are present. If any part(s) are missing or damaged, please contact your local furniture dealer. For efficient and speedy service, please indicate the model number and code letter of part(s) needed.

**\*\*\* Do not fully tighten screws until fully assembled \*\*\***

### PARTS LIST

NO	DESCRIPTION	SKETCH	QTY
A	HEADBOARD		1 Pc
B	FOOTBOARD		1 Pc
C	RAILS		2 Pcs
D	SLATS		5 Pcs
E	BED CORNER FIXING PLATE		4 Pcs

### HARDWARE LIST

1	SCREW BOLT(Ø5/16*100MM)		8 Pcs
2	TIGHT FIRMWARE		8 Pcs
3	HEXAGON NUT		8 Pcs
4	ALLEN WRENCH		1 Pcs
5	LONG SCREW ( 7MM*20MM)		16 Pcs

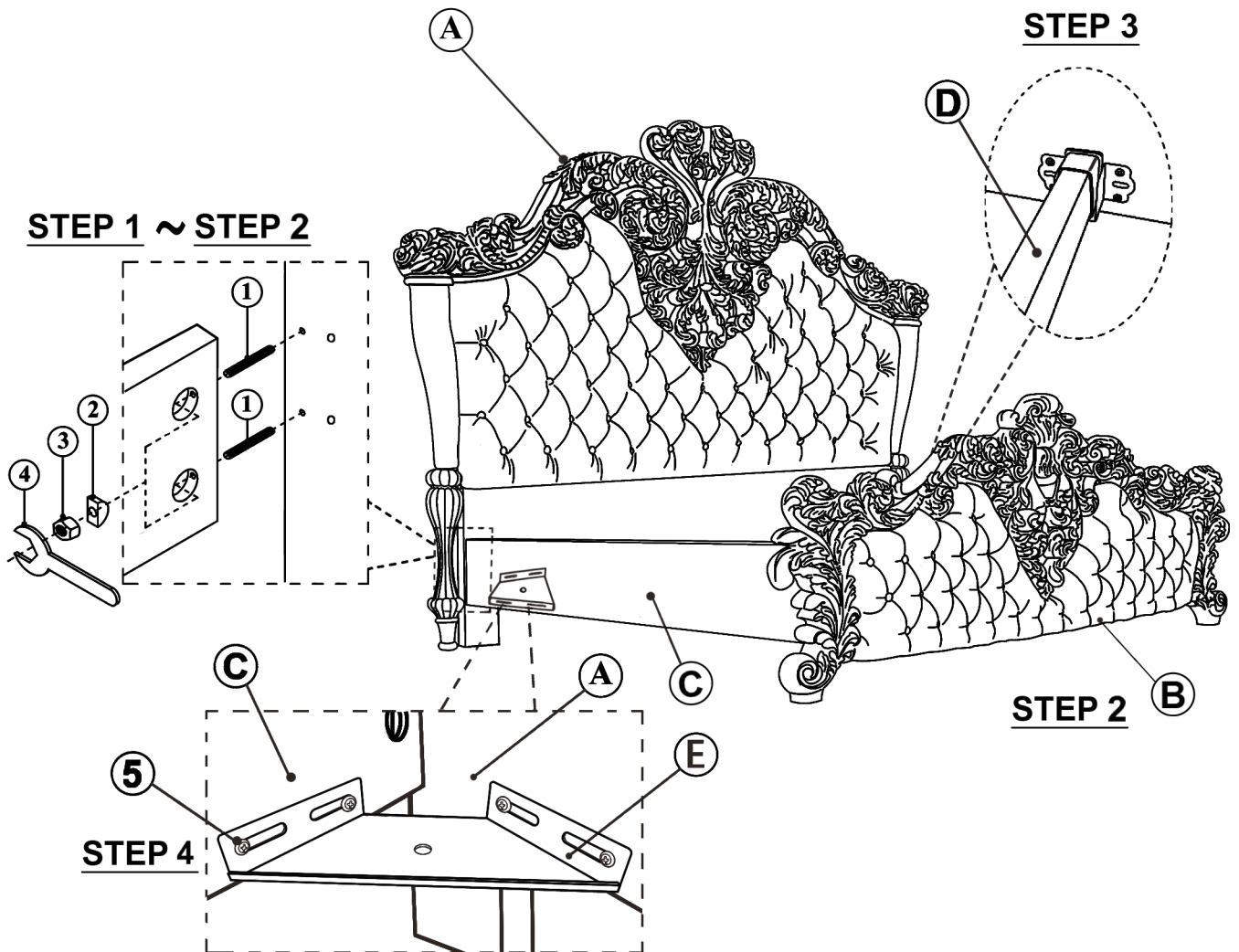

MADE IN CHINA

COMPLETED