

---

# Assembly Manual

## Power Recliner Armchair with Cupholders

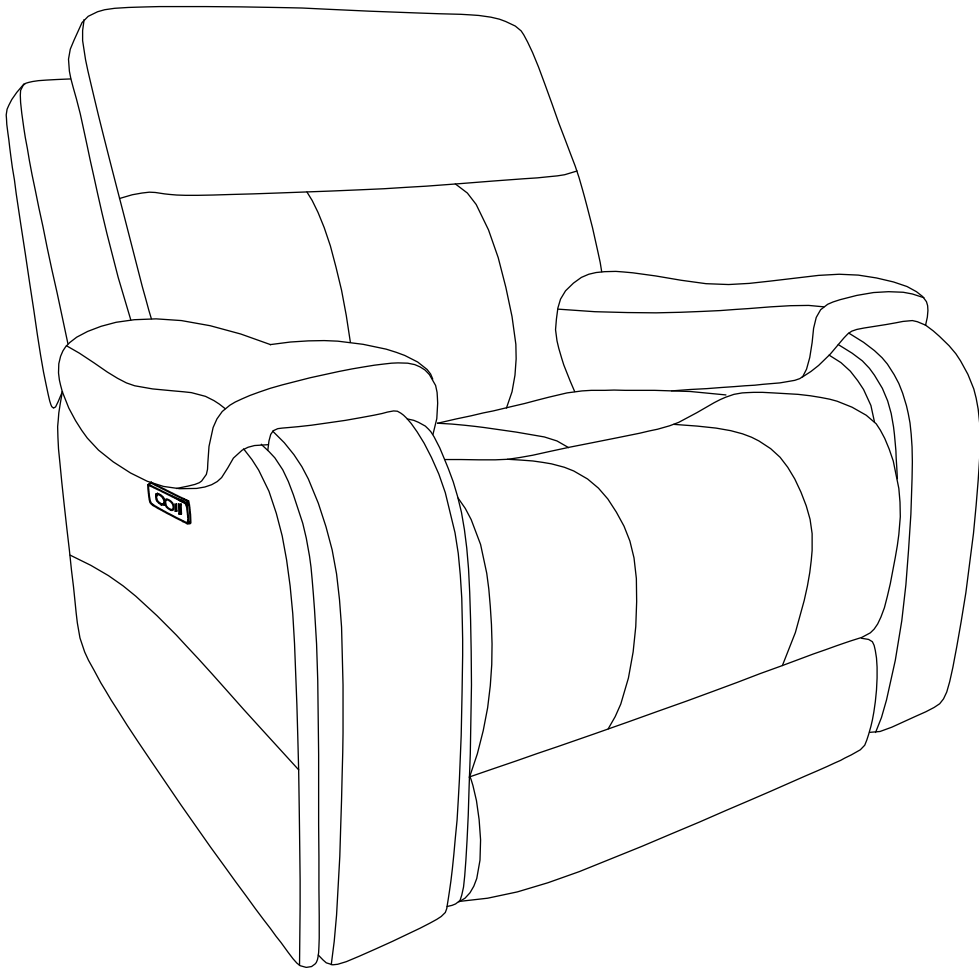

### CAUTION

THIS ASSEMBLY MANUAL CONTAINS IMPORTANT SAFETY INFORMATION.

PLEASE READ AND KEEP FOR FUTURE REFERENCE.

---

## Count parts before assembling.

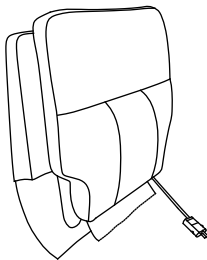
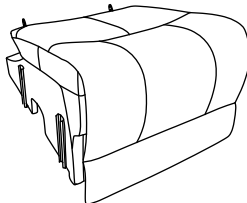
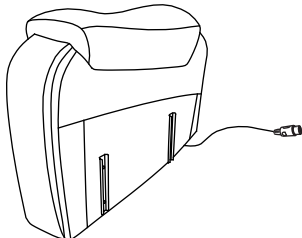
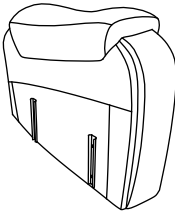
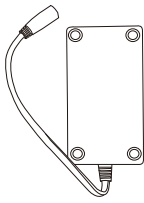
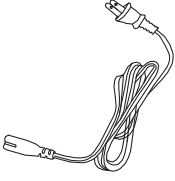
<b>A</b> 1pc 	<b>B</b> 1pc 	<b>C</b> 1pc 
Backrest	Seat	Left Armrest
<b>D</b> 1pc 	<b>E</b> 1pc 	<b>F</b> 1pc 
Right Armrest	Power Adapter	Power Cord for Adapter

### Step 1

Cut the plastic ties to remove the hardware pack (Includes: Power Cord for Adapter (F), Power Adapter (E)).

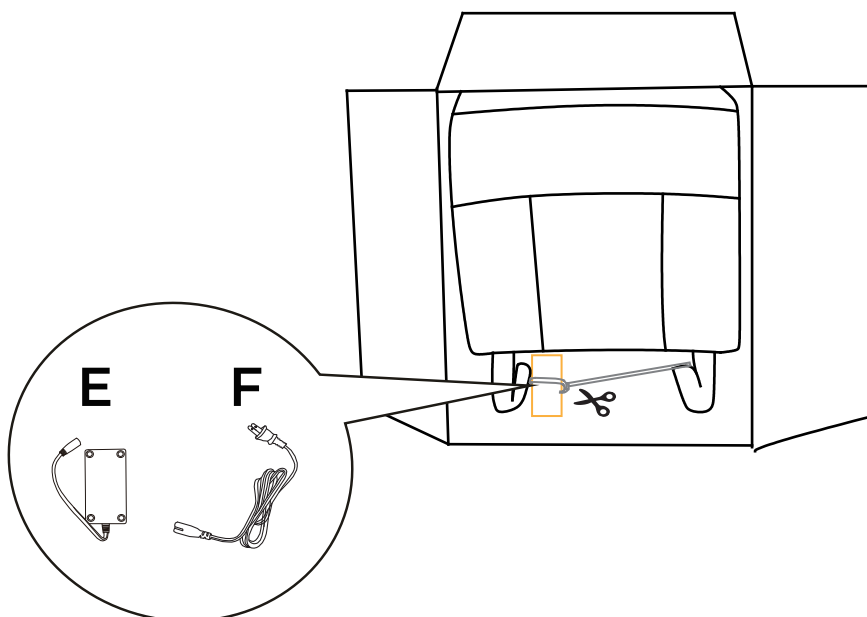

---

## Step 2

Slide the Left Armrest (C) and Right Armrest (D) into the Seat (B).

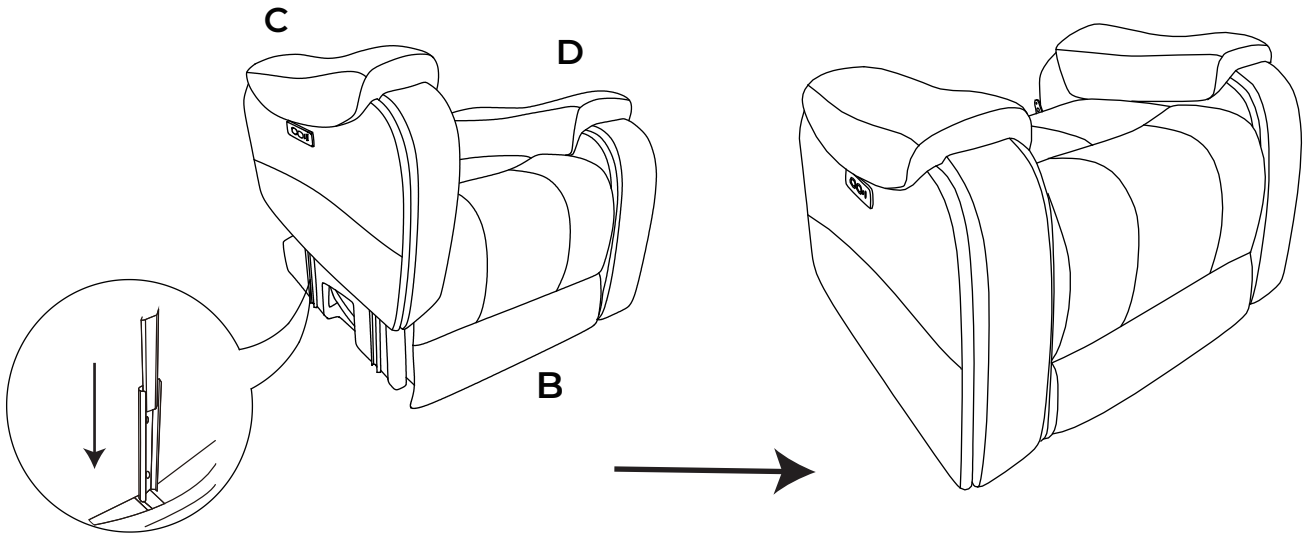

## Step 3

Zip up the bottom of the Back (A) and the Seat (B) together.

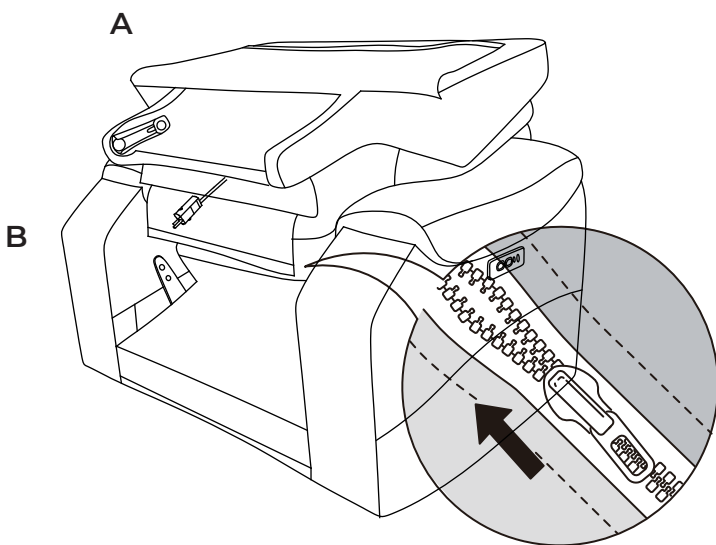

## Step 4

Slide the Back (A) into the metallic quick connectors of the base.

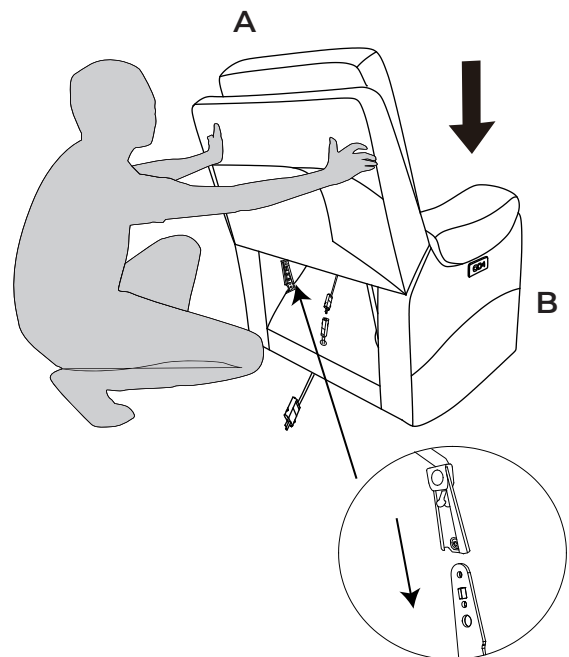

---

## Step 5

Connect the wire (N) from Left Armrest (C) to the corresponding wire (L) on the Seat (B).

Connect the wire (I) from Backrest (A) to the corresponding wire (H) on the Seat (B).

Locate the Power Adapter (E) and connect to its corresponding receiver (G) on the base of the Seat (B).

Connect one end of the Power Cord for Adapter (F) into the Power Adapter (E).

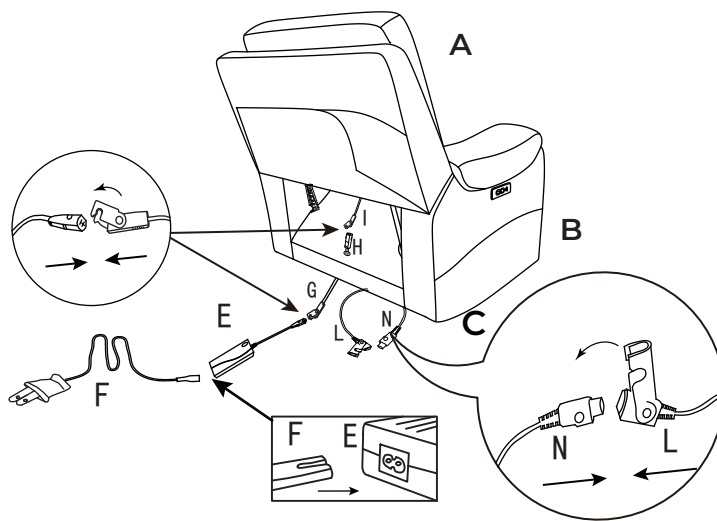

## Step 6

Attach the back cover to the bottom of the seat with Velcro.

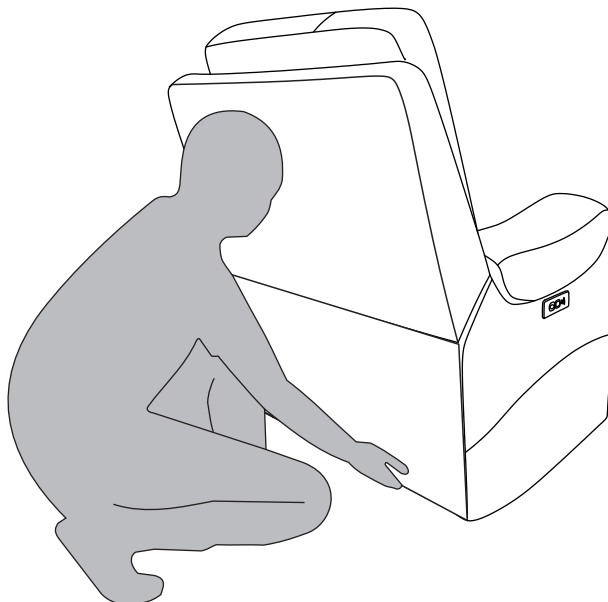

---

## Step 7

Plug the Power Cord for Adapter (F) into the power outlet.

Note: After all the connections are made, the green LED will light up.

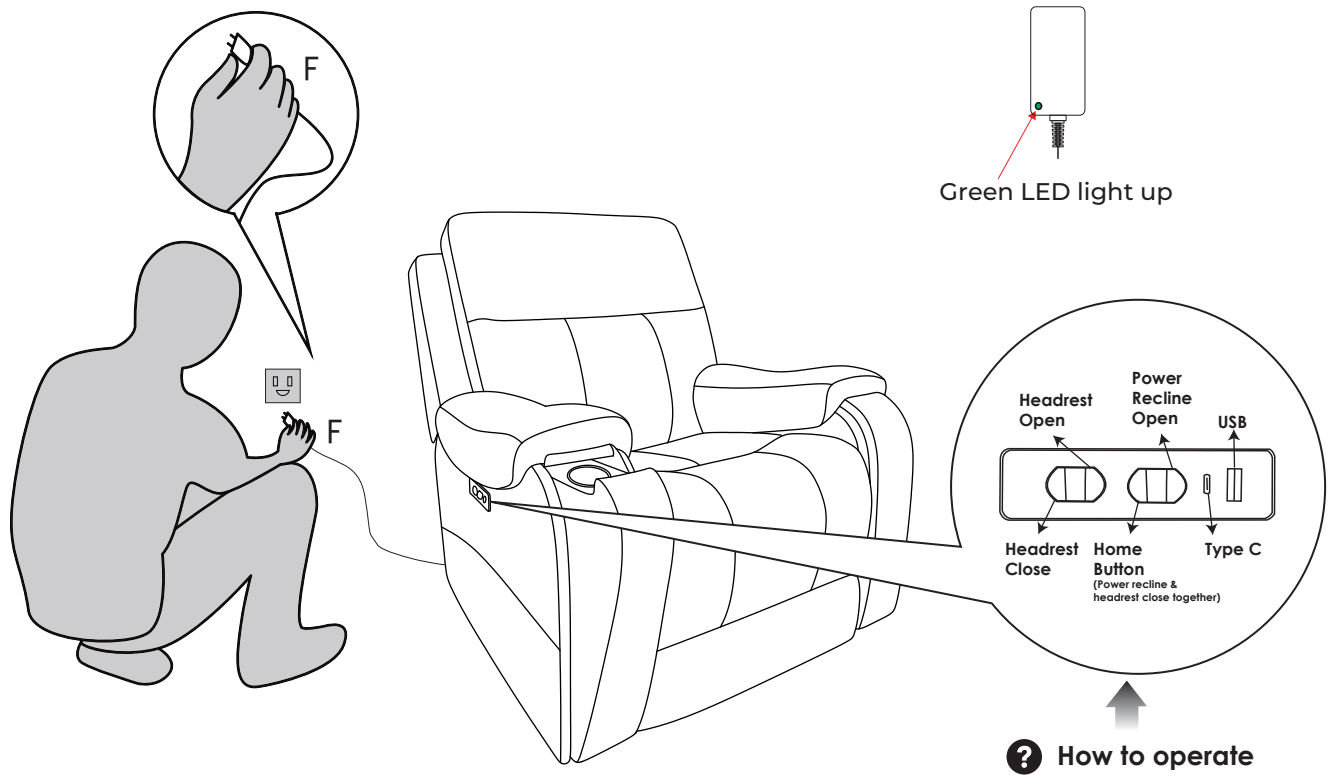

Pull out to reveal the cupholders.

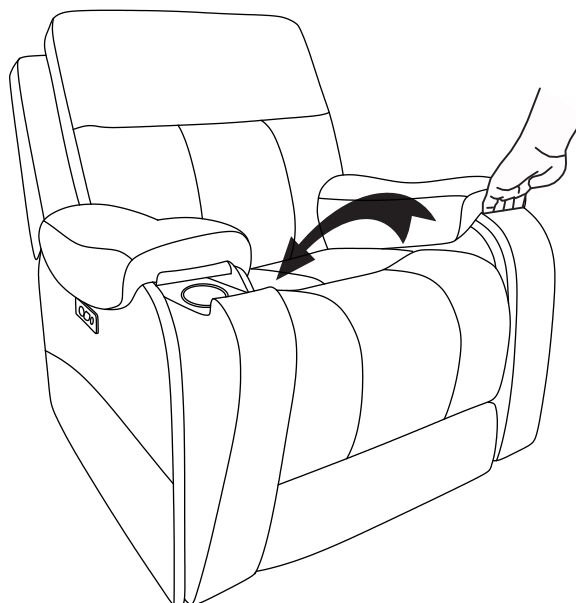

---

## **PRODUCT WARRANTY**

- 1-year limited on leather against splitting, peeling, and/or tearing.
- 1-year limited on internal and external frame structure.
- 1-year limited on cushioning material, seat springs and mechanism.

## **CARE & MAINTENANCE**

Periodic dusting will prolong the life of your leather.

General cleaning can be done with a damp, clean, soft white cloth.

Periodically, a mild leather cleaner can be used on the headrests and arm-rests. This will help prevent buildup of body and hair oils which can harm the leather over time.

For more stubborn stains, a mild leather cleaner can be used or consult a professional leather technician.