

Swivel Chair

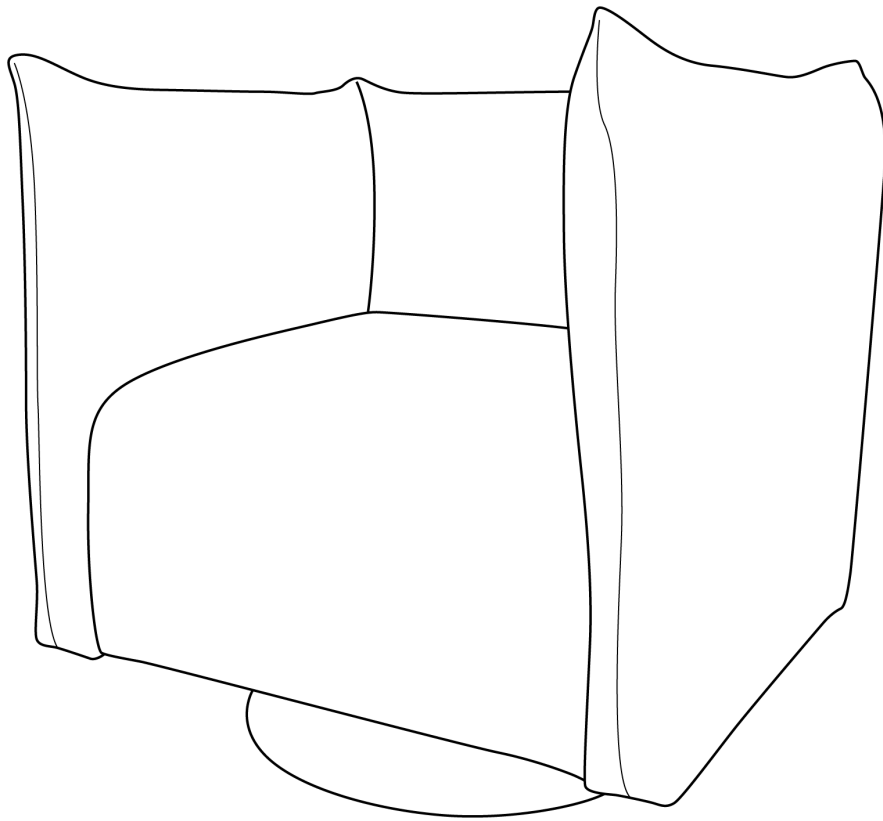



Estimated time for assembly:

10 mins



Weight limitations are as follows:

Maximum Load
300 lb

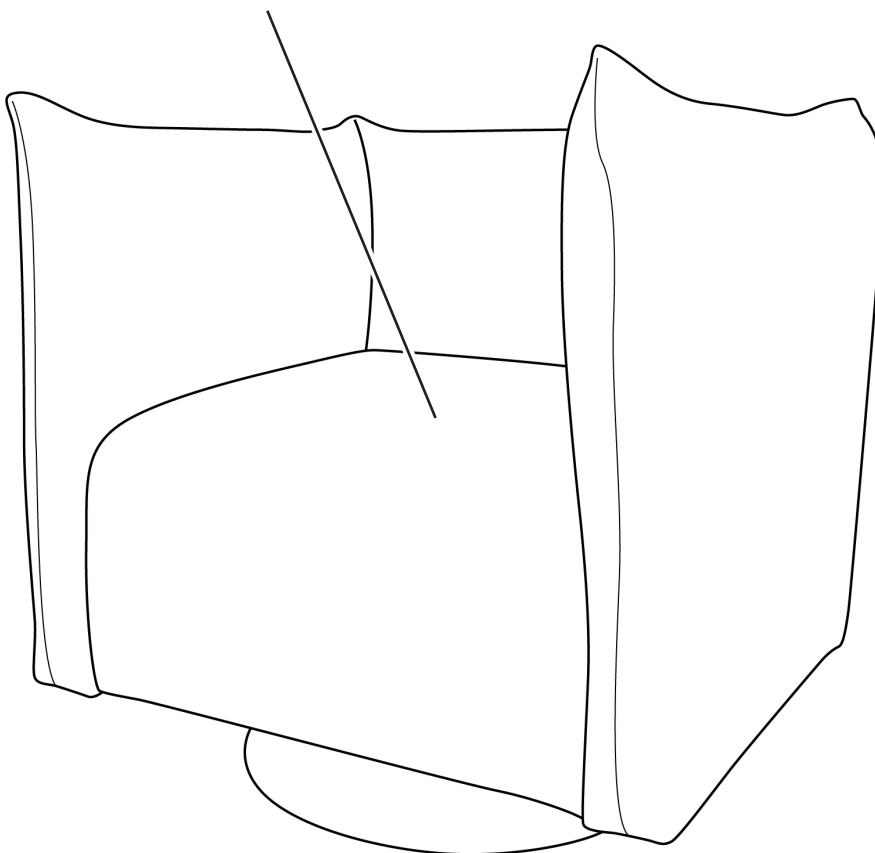



Assemble the furniture on an empty carton, carpet, or rug to prevent scratches or damage.

For safety, please keep pets and children away from the assembly area.

Ensure the product is fully assembled before use. If you are missing any hardware or products, do not use it until you have restored the missing parts.



This furniture requires 2 people for assembly.

Read this instruction manual prior to assembly to familiarize yourself with the various steps.

Lay out all components and hardware separately on a flat surface and make sure that no parts are missing or damaged before assembly. Do not destroy or discard any packaging until you are certain that you have all the necessary parts for assembly.

Hand tight all hardware and careful not to over tighten to avoid damaging the product.

CAUTION

There are small components used in the construction of this product. Loose items should be kept away from pets and children to avoid a choking hazard.

Keep all plastic bags and packaging film away from pets and children to avoid suffocation.

PACKAGE CONTENTS

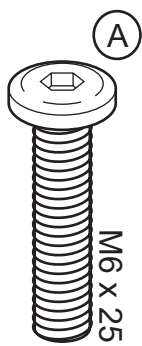
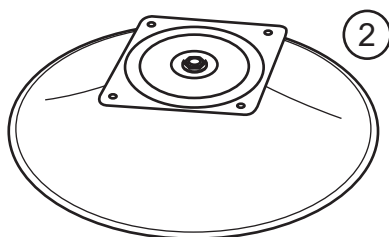
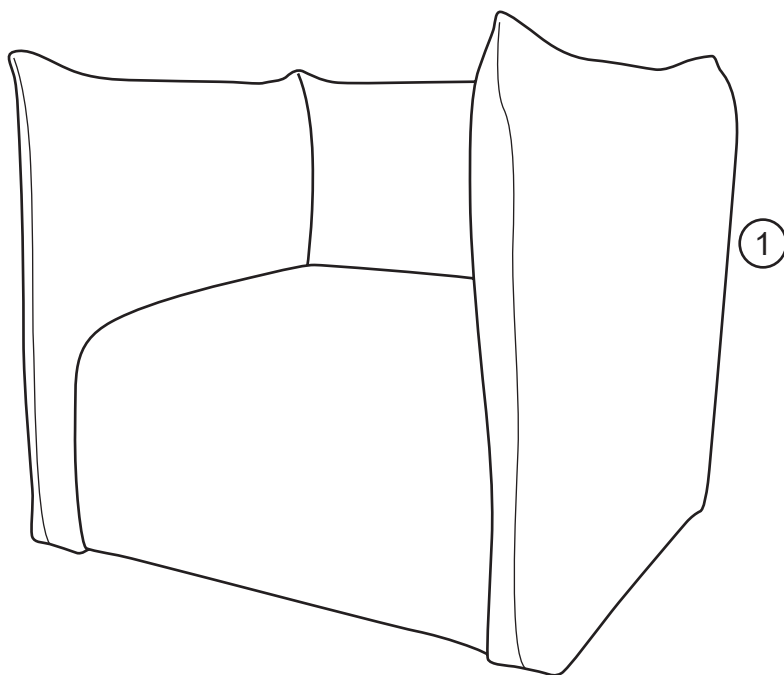

4x + 1x

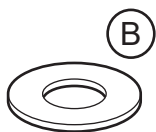

4x + 1x

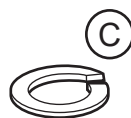

4x + 1x

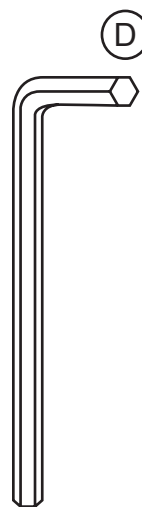

1x

PACKAGE CONTENTS

CODE	DESCRIPTION	QTY
1	Seat	1
2	Swivel Base	1
A	M6 x 25 Bolt	4 + 1
B	M6 Washer	4 + 1
C	Spring Washer	4 + 1
D	Allen Wrench	1

1

Put the seat upside down and attach the swivel base (2) to the seat (1).

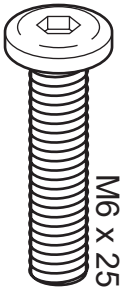

(A) 4x



(B) 4x



(C) 4x

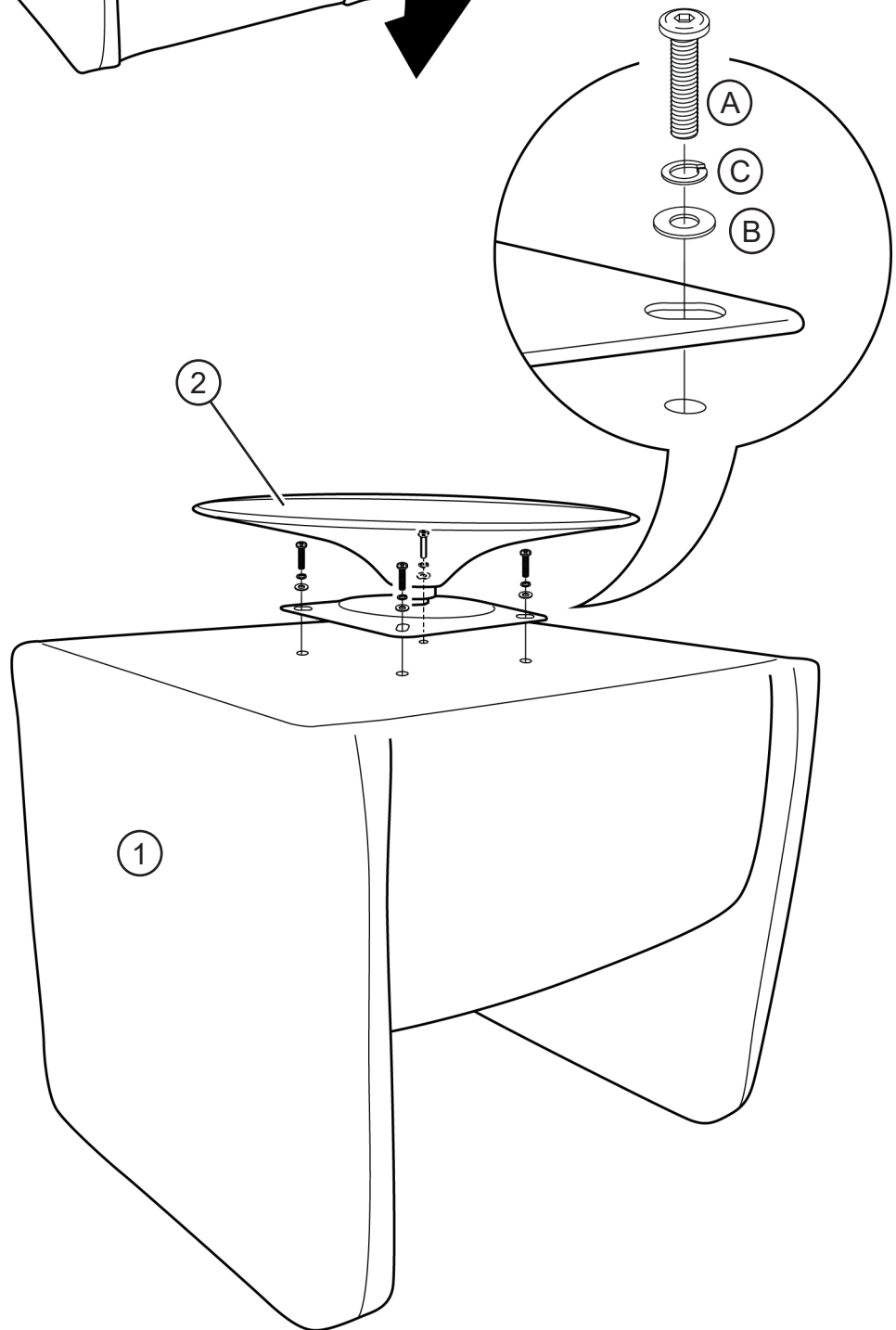
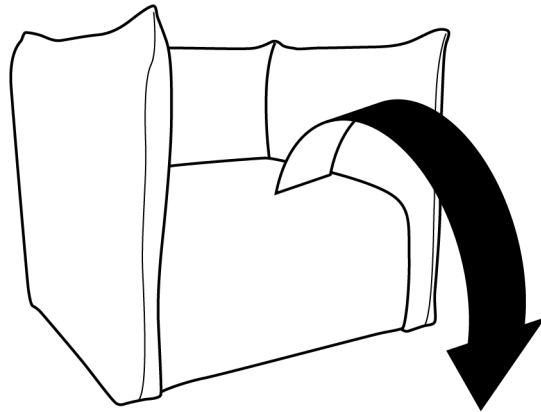

YOU'RE FINISHED!

FURNITURE CARE AND MAINTENANCE

Thank you for your purchase. We want your item to last as long as possible. To ensure the product gives you years of longevity, please follow the recommendations in this care and maintenance guide.



MAINTENANCE

- Tighten all bolts and screws again within the first 2 weeks of assembly.
- Check the tightness of all bolts every 2 months and tighten them if necessary.



CLEANING

- Clean the furniture surface with a lightly dampened cloth or soft brush.
- Regularly clean the cloth surface with a vacuum cleaner.
- Dry the surface immediately after cleaning.

⚠ DO NOT use bleach or alcohol to clean the surface.

⚠ WARNING

The manufacturer and seller are not responsible for any and all liability relating to personal injury, property damage or losses, whether direct, indirect, or incidental, resulting from the incorrect attachment, improper use, inadequate maintenance, unapproved modification or neglect of this product.