

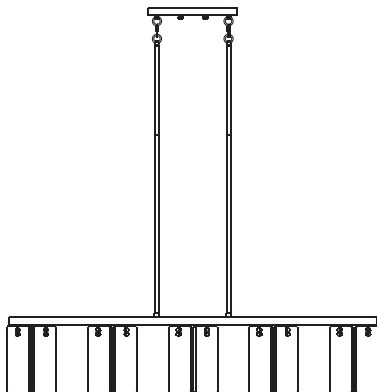

Chandeliers

SKU: HCDL14A
[Instruction Manual]



Please pay attention to the warning signs
Read the instructions with caution before operating
and keep it properly

Warning:

Risk of fire. Min 167°F/75°C supply conductors. Consult a qualified electrician to ensure correct installation. Before installation, please turn off the main power of the circuit breaker to prevent possible electric shock.

Installation Instructions

FIG.1. Turn the wall switch to the "OFF" position. Depending on which type of fuse box in your home:

FIG.2. Either turn the main (Master) switch to the "OFF" position to cut off the power supply of the entire home, or turn off the individual switch that supplies power to where the fixture will be installed.

OR

FIG.3. Either turn the main (Master) switch to the "OFF" position to cut off the power supply of the entire home, or unscrew the fuse that supplies power to where the fixture will be installed.

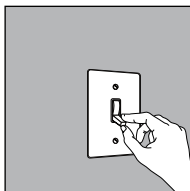

FIG.1 WALL SWITCH

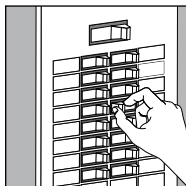

FIG.2 BREAKER PANEL

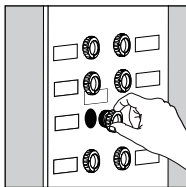
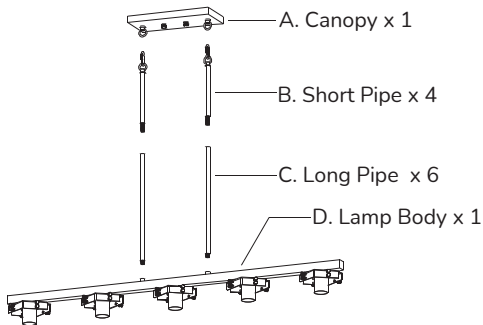

FIG.3 FUSE BOX









PACKING LIST



1.Pass the power cord of Lamp Body (E) through Chain (C), Pipe (D) and Canopy (A).

2.Tighten the connection between Pipe (D) and Lamp Body (E).

INSTALLATION KIT

AA	x1	BB	x2	CC	x1	DD	x3
							
Mounting Bracket		Outlet Box Screw		Ground Screw		Wire Nut	
EE	x40	FF	x2	GG	x2	HH	x20
							
Hand Straight-threaded Screw		Knurled Nut		Quick Link		Glass Sheet	
II	x80						
							
Silicon Washer							

1. Straight-threaded Screw (EE), Silicon Washer (II) have some extra pieces for back-up.
2. Mounting Bracket (AA), Ground Screw (CC), Knurled Nut (FF) have been pre-installed on Canopy (A).
3. Straight-threaded Screw (EE), Silicon Washer (II) have been pre-installed on Lamp Body (D).
4. Quick Link (GG) have been pre-installed on Short Pipe (B).

INSTALLATION

Step 1:

1. Loosen the Knurled Nut (FF) from Canopy (A), and take out the Mounting Bracket (AA).

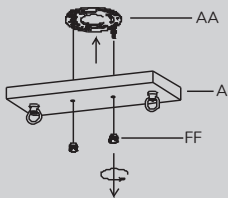

Step 2:

1. Pass the power cord of Lamp Body (D) through long Pipe (C) and Short Pipe (B)
2. Connect long Pipe (C) to the joint of Lamp Body (D), then screw Short Pipe (B) into the teeth of long Pipe (C) and tighten it.

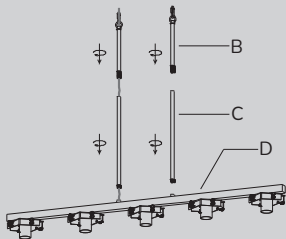

Step 3:

Pass the power cord through Canopy (A). Unscrew the nut on Quick Link (GG), attach Quick Link (GG) to Canopy (A), and then tighten the nut of Quick Link (GG).

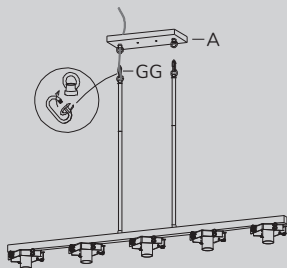
**Step 4:**

1. Take off the screws from the outlet box, and secure the Mounting Bracket (AA) onto the box with the screws taken off or Outlet Box Screw (BB).

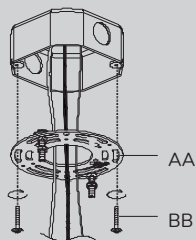

Step 5:

1. Wrap the ground wire from the outlet box around the Ground Screw (CC) on the Mounting Bracket (AA), and then connect the ground wire from the fixture to the ground wire from the outlet box.
2. Connect the wires from the fixture to the house supply wires, neutral wire (white) to neutral wire, and hot wire (black) to hot wire.
3. Spread apart the wires so that the hot wires are on one side of the outlet box and the neutral wires are on the other side.

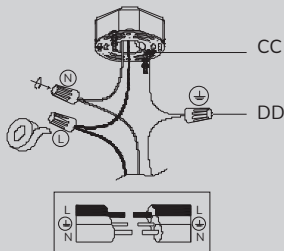

Step 6:

The hole of A is tightened by the screw of Mounting Bracket (AA) and locked with Knurled Nut (FF).

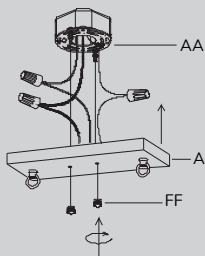

Step 7:

Put the Silicon Washer (II) on the Straight-threaded Screw (EE), align the holes of Glass Sheet (HH) with the holes on Lamp Body (D), and then screw the Straight-threaded Screw (EE) onto the teeth of Lamp Body (D) to fix the glass sheet.

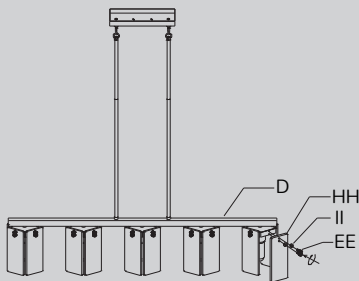

Step 8:

E26 Bulbs X 5
(Max 60W each, not included)

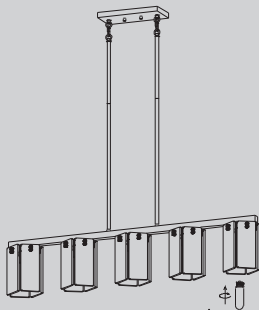

E26 Bulbs X 5
(Max 60W each, not included)

Specifications

- Input Voltage: 120VAC 60Hz
- Max.load Power: Incandescent Bulb 60w
- Socket Type: Standard Medium E26

One Year Limited Warranty

Supported by our professional R&D team and QC team, we provide One Year Warranty for materials and workmanship from the purchase date. Please note that the warranty does not cover damage caused by personal misuse or improper installation. Please attach your Order ID and Name so that our dedicated customer service team can help you better.



Made in China