

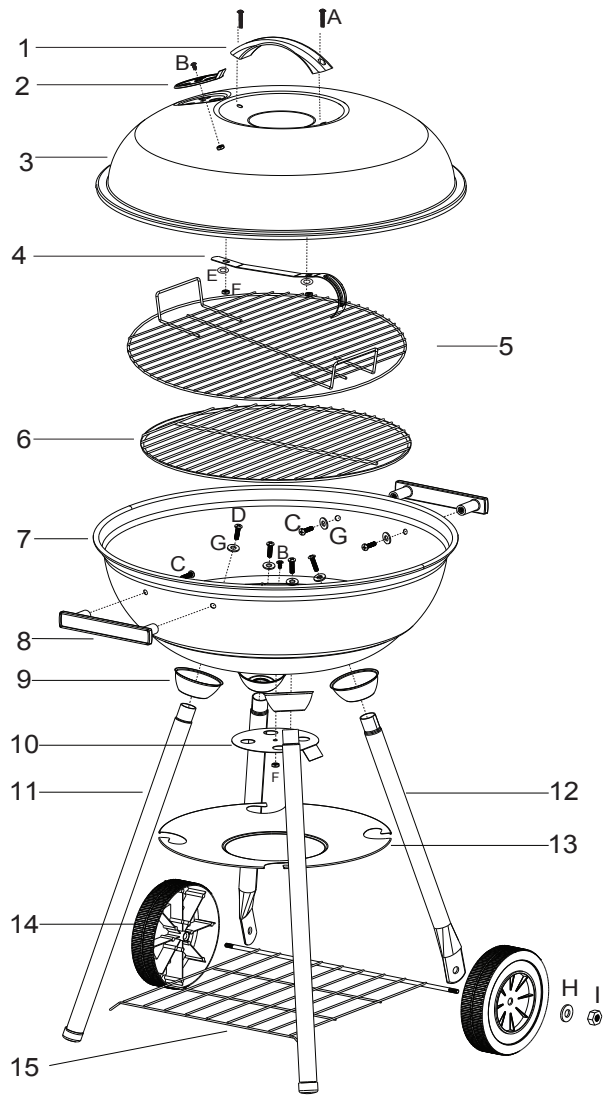









# INSTRUCTION MANUAL

## EXPLODED VIEW



## PARTS LIST:

No.	Description	Qty	Hardware list
1.	lid handle	1	
2.	air vent	1	
3.	lid	1	
4.	hanger	1	
5.	grill	1	
6.	grate	1	
7.	firebowl	1	
8.	bowl handle	2	
9.	leg holder	4	
10.	ash leak	1	
11.	long leg	2	
12.	short leg	2	
13.	ash tray	1	
14.	wheel	2	
15.	wire rack	1	
			A  x2
			B  x2
			C  x4
			D  x4
			E  x2
			F  x4
			G  x8
			H  x2
			I  x2

**PRE-ASSEMBLY CHECK LIST:**

1. To assure fast and easy assembly, follow the instructions below in their proper sequence.
2. Check all parts carefully and compare them to the parts listing.
3. Report any missing parts to the company from which you purchased the product.

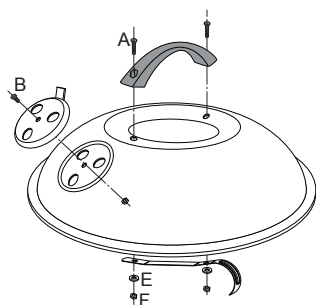

**VIEW-1**

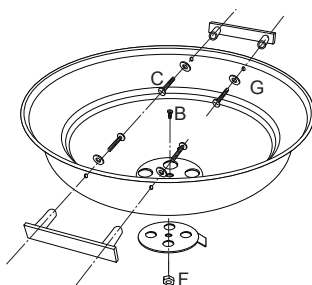

**VIEW-2**

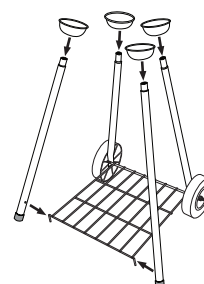

**VIEW-3**

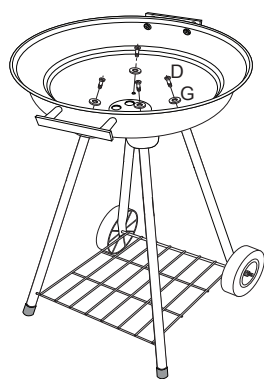

**VIEW-4**

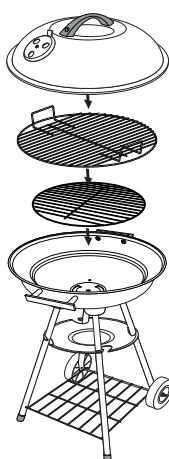

**VIEW-5**

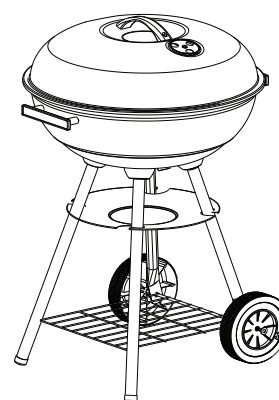

**VIEW-6**

**ASSEMBLY STEPS**

1. Install the lid handle(1) and lid hanger(4) to the lid(3), using two screws(A), washers(E)&nuts(F).
2. Install the air vent(2) to the air hole of the lid(3), using screw(B) & nut(F).
3. Install the bakelite handle(8) to the firebowl(7), using four screws(C) and washer (G).
4. Insert leg holder(9) on the short legs(12) & long legs(11), and attach them to the firebowl(7) bottom one by one. Using screw(D) 4pcs and washer(G) 4pcs.

**NOTE: ONE HANDLE SHOULD BE LOCATED BETWEEN THE TWO LONG LEGS, AND THE OTHER HANDLE SHOULD BE LOCATED BETWEEN THE TWO SHORT LEGS.**

5. Insert the wire rack(15) into the legs ends. the bent tip goes into the holes of the long legs(11) first, (with the bent tip pointing in the opposite direction of the grill). Then align and insert the other ends into two short legs(12). (Make sure the hole which is closest to the end of the leg faces outward).
6. Insert wheels(14), white plastic washers(H), and secure with lock nuts(I) on both sides.
7. Install the ash leak(10) to the bottom of the firebowl(7), using one screw(B) & nut(F).
8. Tighten all the screws and nuts,install the ash tray(13) by aligning slots with legs and rotating to lock in place.
9. Place the charcoal grate(6) onto the firebowl, and place the cooking grill(5). Then finished the assembly.

**IMPORTANT:** AS WITH ANY ROUND SMOKER, CARE MUST BE TAKEN TO PREVENT HEAT DAMAGE TO ANYTHING AROUND OR UNDER THE GRILL.

DO NOT USE WATER ON BBQ WHILE HOT AS THIS WILL DAMAGE THE FINISH.

CLOSE ALL VENTS TO EXTINGUISH COALS

**WARNING**

GREAT CARE HAS BEEN TAKEN DURING PRODUCTION TO REMOVE SHARP EDGES BUT YOU SHOULD HANDLE ALL COMPONENTS WITH CARE TO AVOID POSSIBLE INJURY.

# Charcoal BBQ / Fire Pit Care Sheet

Please retain this document for future reference

## Maintenance and Protection

To clean, wash with a mild soap and water solution, rinse and dry thoroughly with a soft cloth. Do not use bleach, acid or other solvents.

In order to prolong the life of your BBQ / Fire Pit, we recommend that it is stored undercover in a dry area when not in use. If you are unable to store your furniture in a garage or shed during the winter months or periods of prolonged wet weather, it is strongly recommended that you cover the furniture with a suitable waterproof furniture cover.

## Safety

What safety precautions should I be aware of?

**CAUTION:** Do not use liquid fire starter or any other combustible liquid to start the fire.

**WARNING:** Take care not to touch or attempt move the fire pit after it has been lit for at least 1 hour after the fire is out. Ideally then wear gloves to protect yourself.

**WARNING: PRACTICE FIRE SAFETY AT ALL TIMES**

1. USE WITH ADULT SUPERVISION ONLY
2. DO NOT LEAVE THE FIRE PIT UNATTENDED WHILE BURNING
3. DO NOT PLACE THE FIRE PIT NEAR TO ANY FLAMMABLE OR COMBUSTABLE MATERIALS WHEN BURNING
4. OUTDOOR USE ONLY
5. POSITION WELL AWAY FROM OVERHANGING TREES, ETC
6. DO NOT USE ON BALCONIES OR WOODEN DECKS

## How do I care for my Fire Pit?

To help restore the original colour of your fire pit due to weathering or any paint chips or scratches that occur, we suggest a black heat resistant stove spray paint. But please take care to follow the manufacturer's instructions carefully regarding application.

## Helpline

Should you experience any problems, need further advice or require replacement fixings then please contact the customer service help line or email support below.