







UPH HEADBOARD

Twin - Full - Queen - King

Examine all packaging material for small parts that may have come loose during shipment. Periodic checks are recommended to insure that all components are in proper position, tight and free from damage. Keep this assembly instruction for future reference. Adult assembly is required. The product is designed for residential use only.

HARDWARE LIST

- A (10) M8*50mm Bolts
- B (10) M8 Spring Washers
- C (14) M8 Flat Washers
- D (4) M8 Nuts
- E (1) Ø5 Allen Wrench
- F (1) Ø5 Open Wrench

PART	QTY	HARDWARE	PART	QTY	HARDWARE
A	10		B	10	
C	14		D	4	
E	1		F	1	

PARTS LIST

- G (1) Headboard Panel
- H (2) Headboard Legs

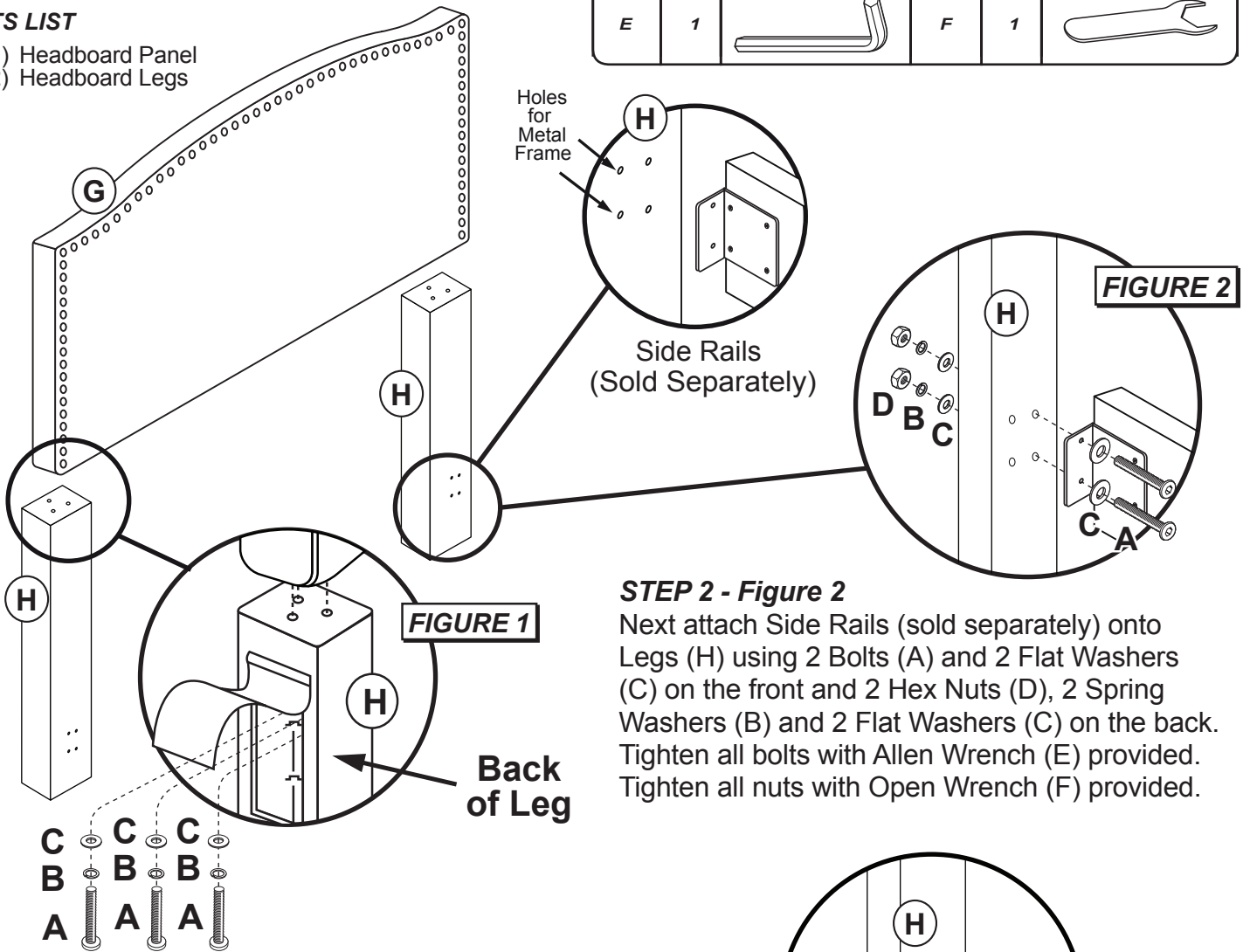

FIGURE 1

FIGURE 2

STEP 2 - Figure 2

Next attach Side Rails (sold separately) onto Legs (H) using 2 Bolts (A) and 2 Flat Washers (C) on the front and 2 Hex Nuts (D), 2 Spring Washers (B) and 2 Flat Washers (C) on the back. Tighten all bolts with Allen Wrench (E) provided. Tighten all nuts with Open Wrench (F) provided.

STEP 1 - Figure 1

Begin assembly by attaching Legs (H) to Headboard (G) using 3 Bolts (A), 3 Spring Washers (B) and 3 Flat Washers (C) per side. Tighten all bolts with Allen Wrench (E) provided.

The Bed Frame  is not included. Sold Separately