

ASSEMBLY INSTRUCTION

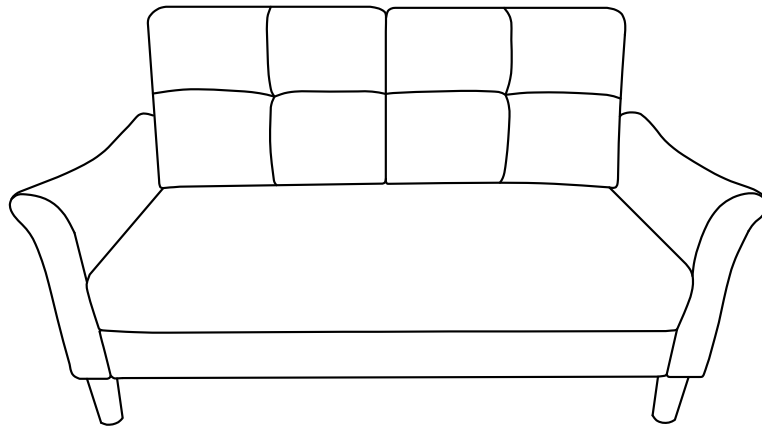

Product Diagram

Parts

- A. Pedestal
- B. Cushion (seat)
- C. Backrest
- D. Cushion (back)
- E. Sofa legs
- F. Reinforcement pads
- L. Armrest (left)
- R. Armrest (right)

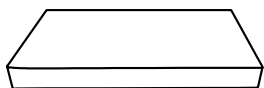
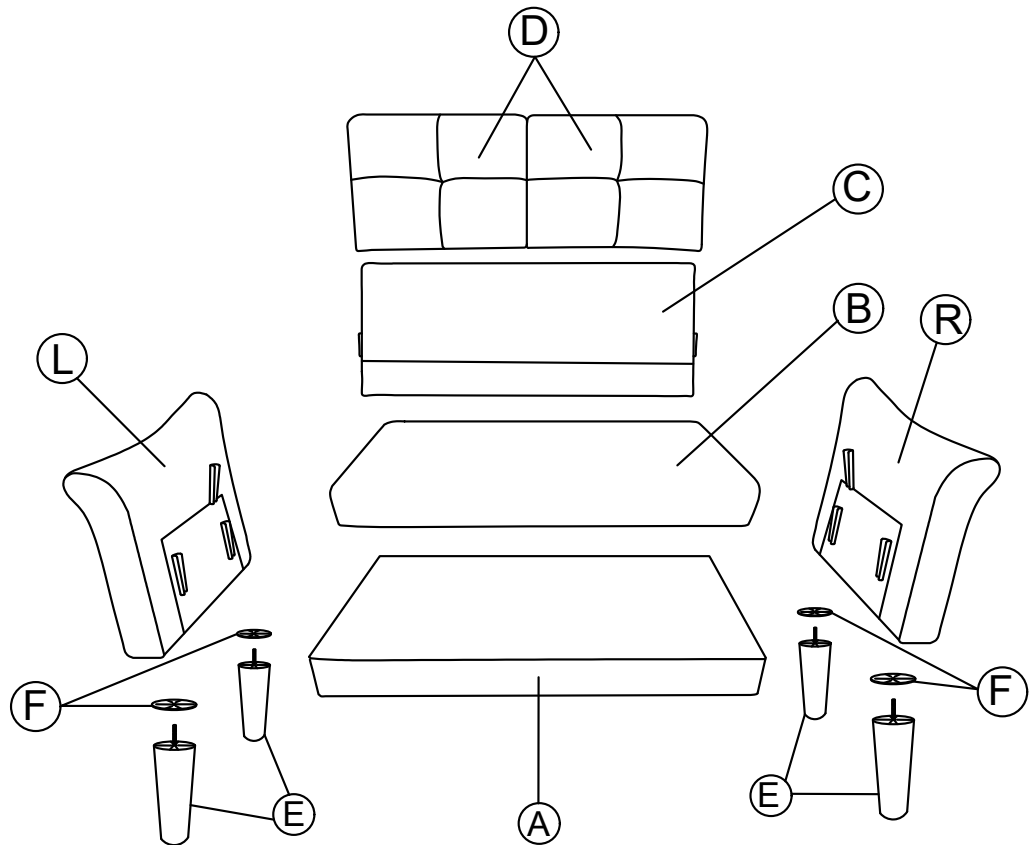

A x1



B x1

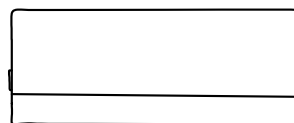

C x1

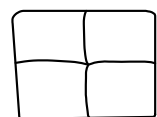

D x2



E x4



F x4



L x1



R x1

Step 1

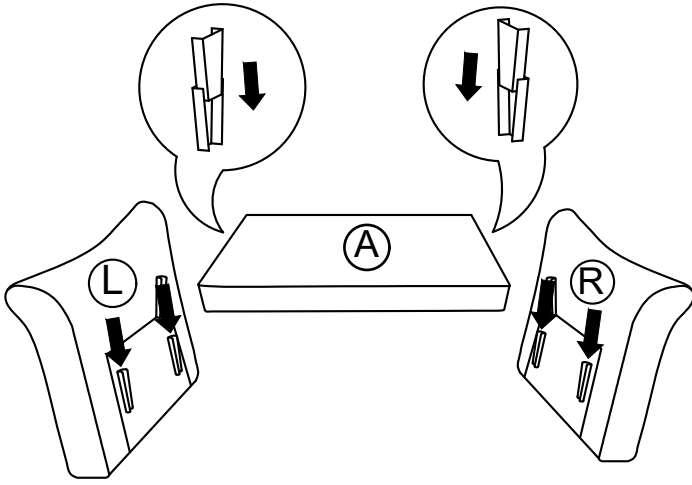

Step 2

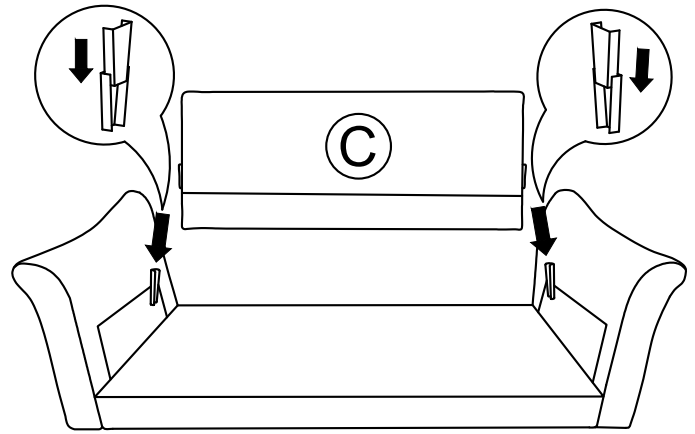

Step 3

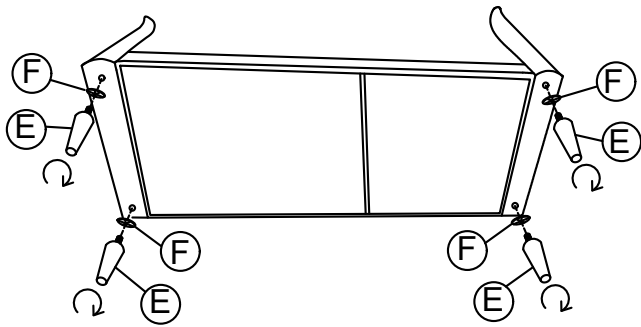

Step 4

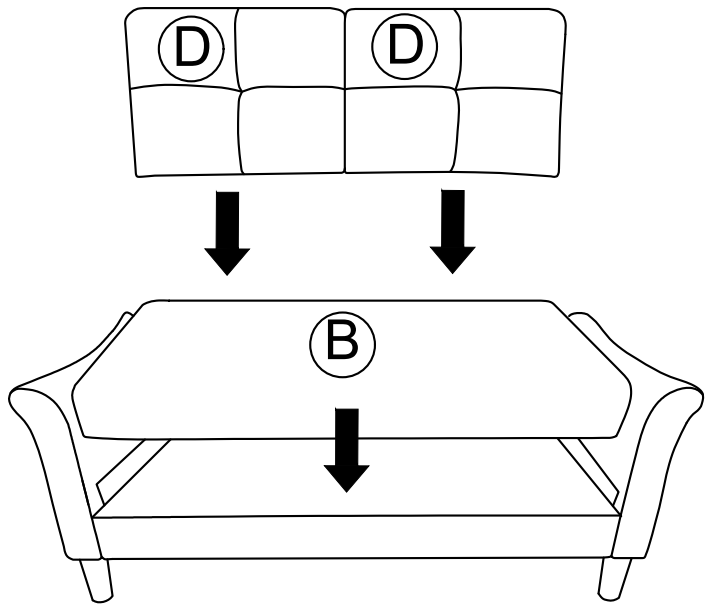

Step 5

