



INSTRUCTION MANUAL

■ ASSEMBLY GUIDE

Congratulations, you are now the owner of a brand new chair!

Following this assembly guide and you will find a quick start guide to assemble your chair. We highly recommend checking out our Assembly Videos as well for even more detailed and visual instructions.

If you run into any difficulty during the assembly, remember to drop us an email as well and our support team will assist you.

■ SIT DOWN ON THE JOB IN CUSTOM COMFORT.

No two people are alike. But no matter what you're built like, there's one chair that's built for everyone's comfort - the chair. Take a look at the diagram below. It's packed with features that make it easy to fine-tune the comfort to meet your unique needs.

■ PRODUCT FEATURES

Pneumatic Seat Height Adjustment

Seat height adjusts to assure correct posture and relieves stress on back, thighs and legs.

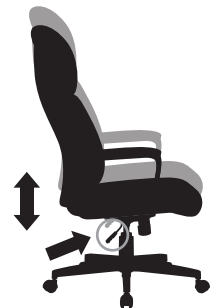
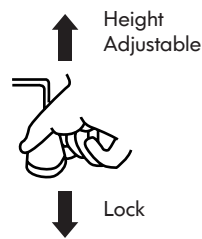

Tilt Tension

Easy adjustment of chair flexibility avoids heavy pushing and relaxes muscles.



Variable Seat Tilt Lock

Simple locking mechanism fixes seat in desired position to assure healthy posture.



PACKAGE LIST

A

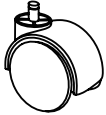

Casters *5

B

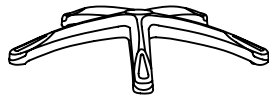

Star Base *1

C



Lift *1

D

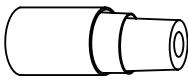

Lift Cover *1

E

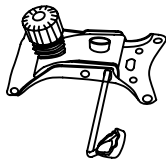

Seat Plate *1

F



Seat Cushion *1

G

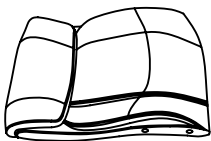

Back Cushion *1

H

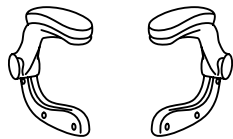

Arms *2

I

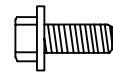

Bolts 1/4x25mm *8

J

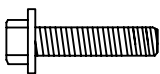

Bolts 5/16x28mm *2

K

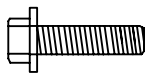

Bolts 5/16x22mm *2

L



Plastic Caps *8

M

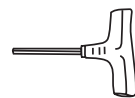

Wrench *1

ASSEMBLY INSTRUCTIONS

Step 1

Turn the Star Base(B) upside down, then press the Casters(A) into the holes at the end of each base leg, insert the Lift(C) into the center hole of the Star Base, the Lift Cover(D) should be placed over the Lift.

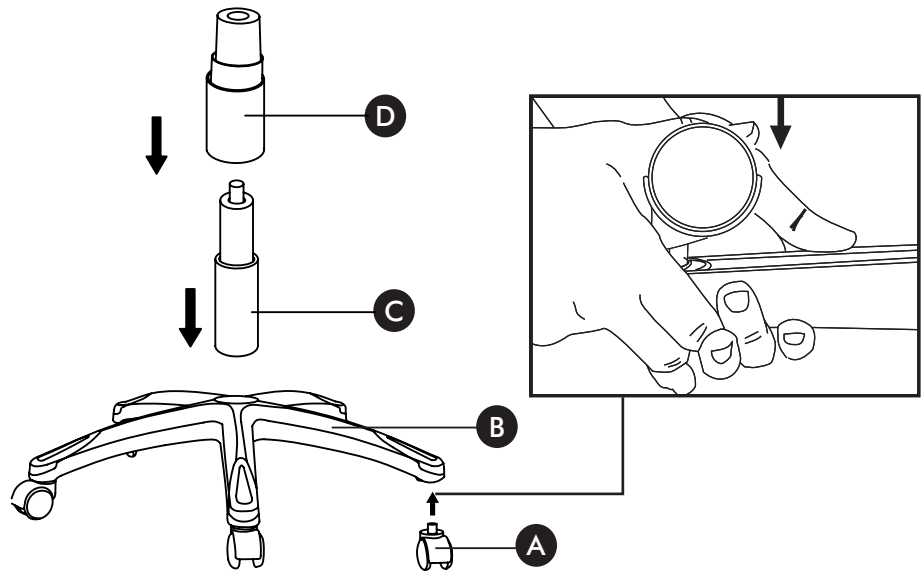

Step 2

Align the Seat Plate(E) over the pre-drilled holes underneath the Seat Cushion(F), make sure that the front of the seat plate is facing the front of the Seat Cushion. Attach the Seat Plate to the Seat Cushion using **TWO Bolts(J)** at the front and **TWO Bolts (K)** at the back, tighten all the bolts with the Wrench(M), being careful not to miss-thread the bolts or damaged the seat.

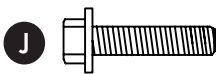

Bolts 5/16x28mm *2

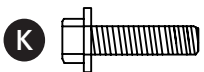

Bolts 5/16x22mm *2

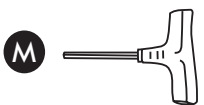

Wrench *1

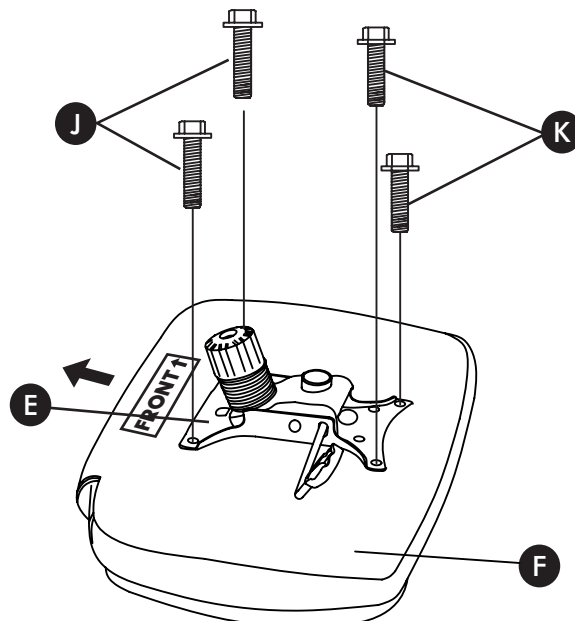

ASSEMBLY INSTRUCTIONS

Step 3

Turn the Seat Cushion(F) upright and align the center hole of the seat plate over the lift, then push the seat cushion down onto the lift firmly until the connection is secure.

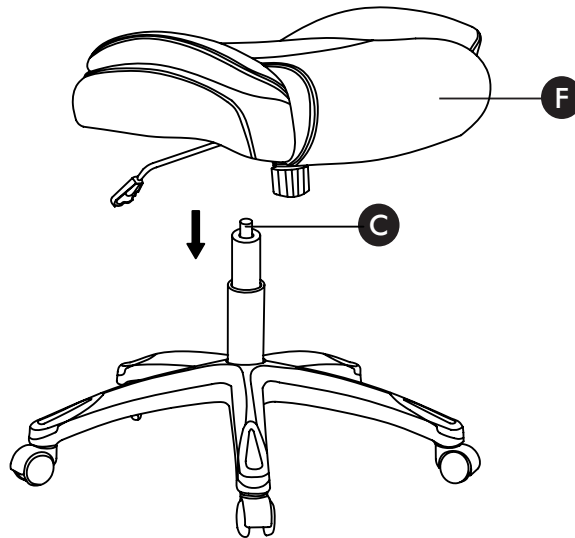

Step 4

Attach the Arms(H) to the Seat Cushion(F) with Four Bolts (I), using the Wrench(M).

NOTE: Arm rests are labeled with an "L" (left) or "R" (right) to show which sides they should be placed on.

NOTE: Do not tighten all the bolts to 100%, make sure it have space to adjust in the next steps.

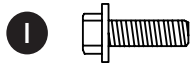

Bolts 1/4x25mm *4



Wrench *1

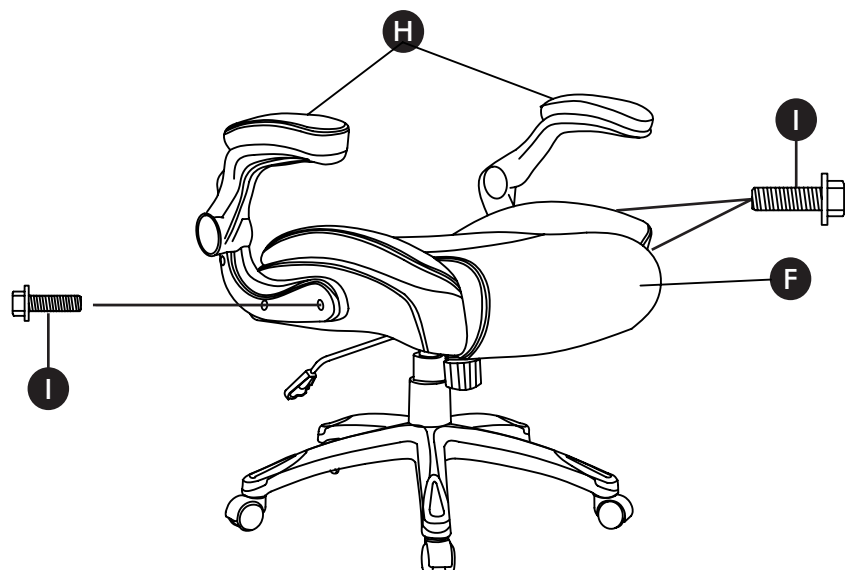

ASSEMBLY INSTRUCTIONS

Step 5

Lay the Back Cushion on the seat of the chair with the top of the cushion toward the front. Attach the Back Cushion(G) to the Arms by inserting Two Bolts (I) in the TOP holes with the Wrench(M).

NOTE: Do not tighten all the bolts to 100%, make sure it have space to adjust in the next steps.

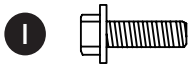

Bolts 1/4x25mm *2

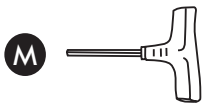

Wrench *1

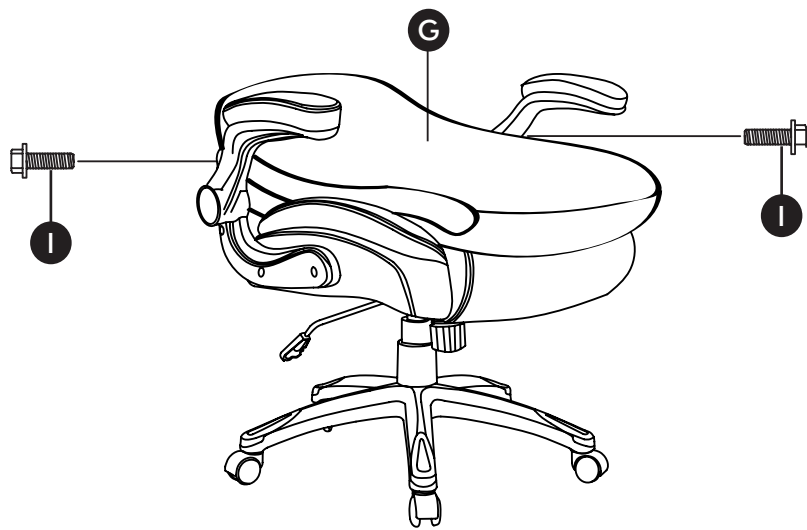

Step 6

Rotate the back of the chair up, then secure it with the LOWER hoels with Two Bolts (I) by using the Wrench(M). **ADJUST BALANCE ON EACH SIDE OF THE CHAIR, AND FULLY TIGHTEN ALL THE BOLTS AT THIS STEP.**

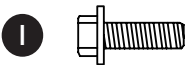

Bolts 1/4x25mm *2

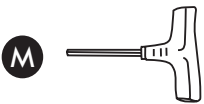

Wrench *1



ASSEMBLY INSTRUCTIONS

Step 7

Press the Plastic Caps(L) into the Arms holes to cover the bolts.

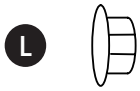

Plastic Caps *8



■ SAFETY AND MAINTENANCE

- Do not stand on the chair, Do Not use the chair as stepladder.
- Use this product for seating one person at a time.
- Do not use the chair unless all bolts and screws are firmly secured.
- Avoid contact with sharp objects to prevent puncturing the fabric.
- Every 6 months, check all bolts and screws to ensure they are tight.
- To clean, spot clean only using a damp towel and mild cleaner, first test on a small, obscure area of fabric.
- Chair weight limit not to exceed **250 lbs.**

■ SAFETY INFORMATION



Sit in the center of the chair, with your back to the backrest



Do not sit at the front edge of the chair



Do not push the chair around when a person is sitting in it



Do not stand on the chair



Do not push down on the backrest when a person is reclined



Do not use the chair with more than one person



Do not place all your weight on the backrest only

■ LIMITED WARRANTY

promises to repair or replace any chair that is found to be defective in material or workmanship within one year from the date of original purchase so long as you, the original purchaser, still owns it. This is your sole and exclusive remedy. This warranty is subject to the provisions below.

EXCLUSIONS:

This warranty does not apply and no other warranty applies to:

- Normal wear and tear, which are to be expected over the course of ownership.
- Misuse, abuse or excessive use of the product.
- Modifications or attachments to the product that are not approved by ICOMOCH.
- Products that were not installed, used, or maintained in accordance with product instructions and warnings.
- Products used for rental purposes or unauthorized retail activities.

■ LIMITED WARRANTY

HOW RETURNS WORK:

Contact us through the contact form on our website and attach the invoice to the message as a proof of purchase. And please also write the reason for return.

We will then get back to you as soon as possible with information on where to send the product(s).

As soon as we have received the product(s) and made an inspection we will inform you of our decision.

If a refund is approved we will automatically credit the purchase to your credit card or original method of payment.