

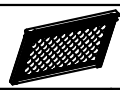











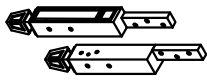



ASSEMBLY INSTRUCTION

Thank you for purchasing this quality product. Be sure to check all packing material carefully for small parts which may have come loose inside the carton during shipment. Separate, identify and count all parts and metal hardware. Compare with parts list to be sure all parts are present. If any part(s) are missing or damaged, please contact your local furniture dealer. For efficient and speedy service, please indicate the model number and code letter of part(s) needed.

*** Do not fully tighten screws until fully assembled ***

COMPONENT PARTS		
DESCRIPTION	PART NAME	Q'TY (PCS)
①	HEADBOARD PANEL 	1
②	FOOTBOARD 	1
③	RAILS 	2
④	SLATS 	3
⑤	SLAT SUPPORT 	3
⑥	LEGS (L & R) 	2
⑦	CROSS BAR 	1

HARDWARE REQUIRED

(A)		FLAT WASHER	Ø5/16"*19*2mm	8 PCS
(B)		LOCK WASHER	Ø5/16"*13*1mm	8 PCS
(C)		BOLT	Ø5/16"*40mm	2 PCS
(D)		BOLT	Ø5/16"*50mm	6 PCS
(E)		FLAT WASHER	M4	1 PC
(F)		P.H SCREW	M4*35mm	6 PCS
(G)		HALF MOON	Ø5/16"*30*8mm	8 PCS
(H)		BOLT	Ø5/16"*12*6mm	8 PCS
(I)		BOLT	Ø5/16"*90mm	8 PCS
(J)		SPANNER WRENCH	M12	1 PC

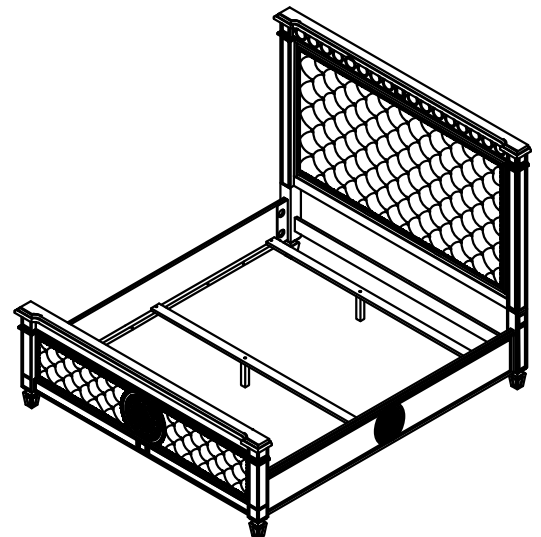

Attention

***Some number parts listed on the instruction sheet may not be in parts bag as they may already be assembled. Carefully check parts and packing materials prior to ordering replacements.

How to assemble:

STEP 1

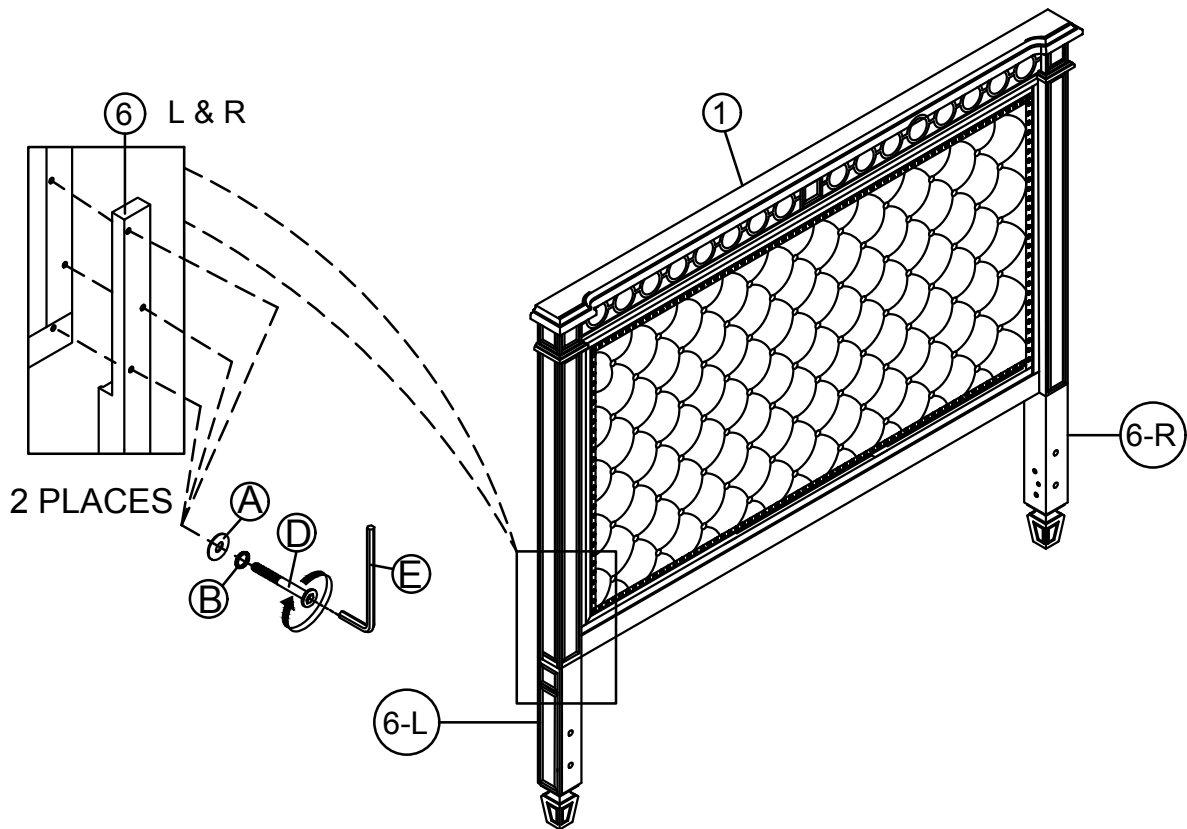

STEP 2

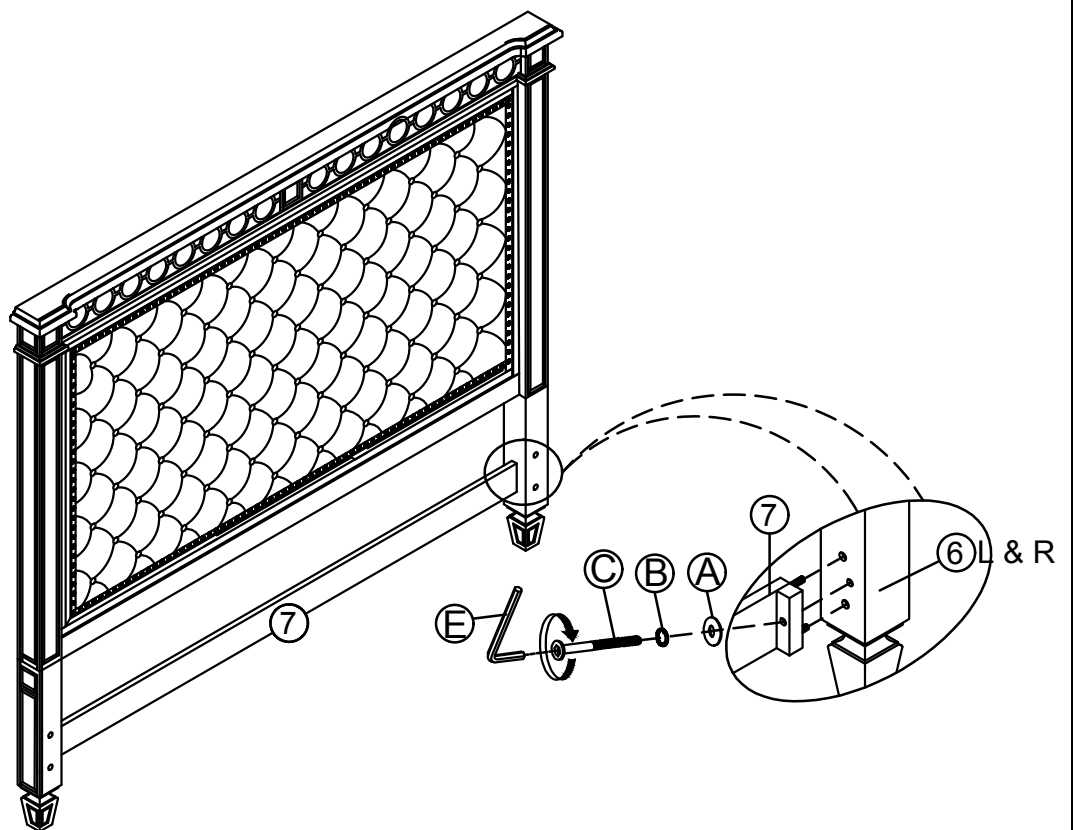

How to assemble:

STEP 3

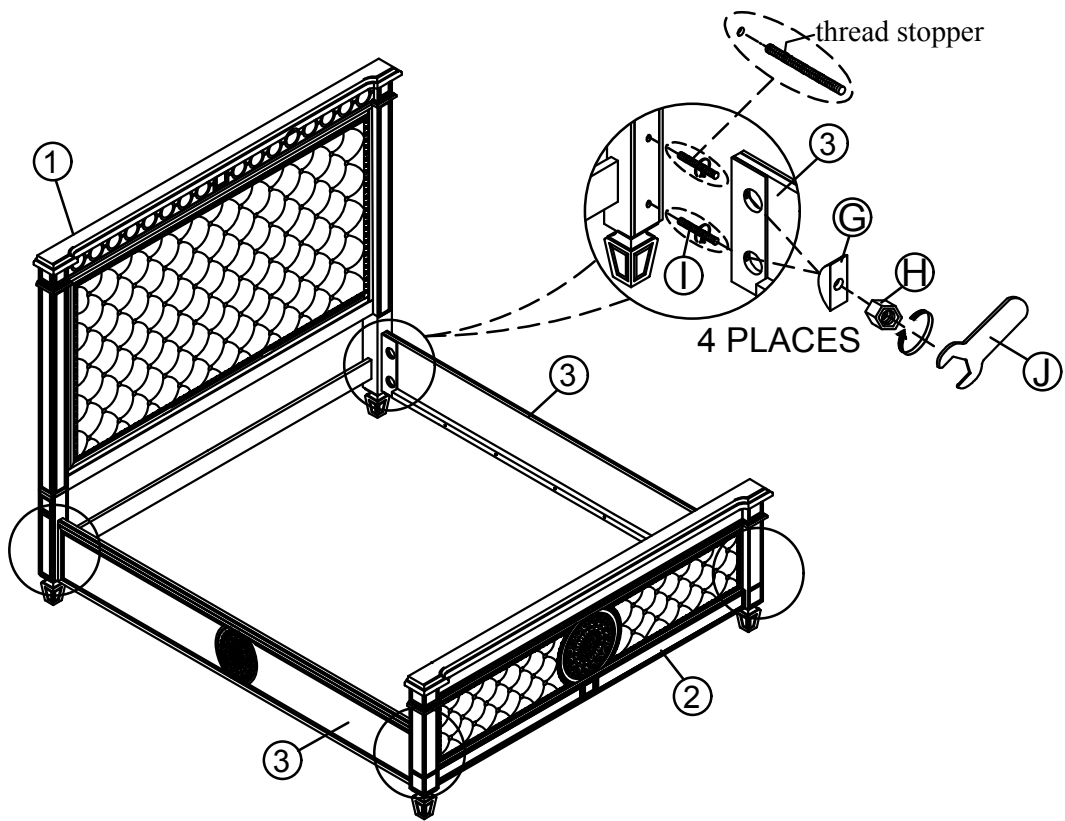

STEP 5

STEP 4

