

Please keep this operation manual properly

ZMZ

## Massage Chair

Operation Instructions

## Luxury Massage Chair

■ Before operating this unit, please read these instructions completely. Specifications and shapes of massage loungers may vary depending on the model.

## Catalog

Thank you for choosing the massage chair. Please read this instruction carefully before use, especially the safety parts, so that you can use the massage chair properly. Please keep this manual after reading and refer to it whenever necessary.

Installation instructions .....	2-3
Product structure .....	4-5
Product installation .....	6-7
Controller instructions .....	8
Operating instructions .....	9-11
Exceptions .....	12
Product maintenance .....	13
Product specifications .....	14

The upgrade and alteration of the functions are subject to prior notice, subject to actual products.

## Product specification

Product name	Specification description
Product name	Luxury Massage Chair
Rated voltage	110V-60Hz
Rated power	120W
Size	150*74*125cm
Weight	Gross weight : 110kg
	Net weight : 91kg

## Safety instructions

To avoid discomfort or injury caused by the use of this massage chair, please consult a doctor before using this product

A person suffering from malignancy

Suffer from heart disease

A pregnant woman, woman, or period person

A man who needs quiet culture

Being treated

A person with a back disorder or abnormal or distorted cervical spine

If you feel pain during use, discontinue use immediately. If you are injured during use, seek medical attention immediately

Do not massage inflamed or inflamed skin

This product is only for family comfort massage enjoyment, not professional massage medical instruments, therefore, can not replace professional treatment

It is recommended to use a massage chair for 30 minutes, massage the same position of not more than 10 minutes, otherwise excessive massage will lead to counterproductive effect, and long time use can cause the massage chair overheating and shortening product life

Do not use this product in gas or oxygen environment

Children under 18 years of age are not eligible for this product

**Warning:** This product is intended for those who are physically, mentally, mentally handicapped, or inexperienced, unless they have received the guardianship or instruction of the person in charge of the product

Children should be supervised to make sure they do not play with this massage chair

If the cord is damaged, it must be replaced by the manufacturer or its maintenance department or similar professional personnel to avoid danger

Equipment surface heating, heat insensitive people must pay attention to the use

## Exceptions

In case of an abnormal situation, please stop using and unplug the power supply to prevent the accident. Please contact the service center if the following process is still invalid

Possible anomalies	processing method
The sound produced during operation	The sound of the structured design does not affect the machine
Plug in the power supply, but the massage chair is inoperable	Check whether the power plug is plugged in or whether it is energized. Check the power on the massage chair to make sure the key is in the "open" position
The use of the process, the controller can operate, but the massage chair can not be operated	After a long period of operation, if the temperature of the massage chair machine is too high, the massage chair will be automatically protected by temperature. Please turn off the power supply and stop using for 30 to 50 minutes, so that the inner heat of the machine will be cooled
In use, the controller is inoperable and the massage chair stops operating	Auto timer function, after starting, if the set time has arrived, please press the button again

## Product maintenance

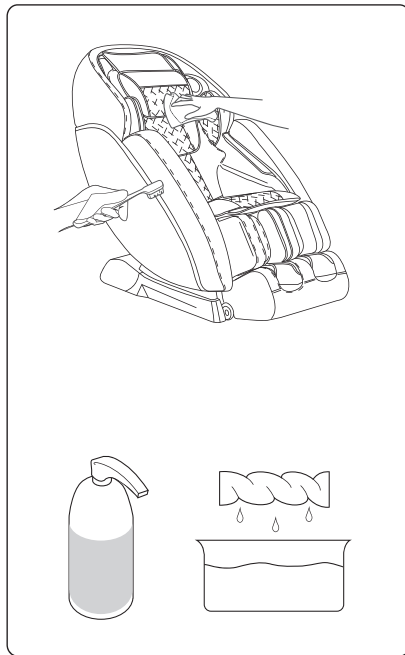

- \* With a dry cloth to wipe the sweat
- \* Use low concentrations of neutral detergent when cleaning stains
- \* Soak the soft cloth, wring it thoroughly, and gently wipe the massage chair

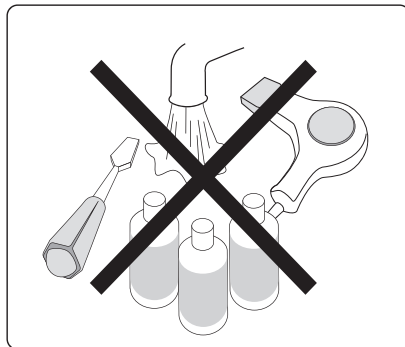

- \* The power plug must be removed when cleaning the massage chair
- \* In addition, do not touch the power plug with wet hands
- \* Please don't clean the massage chair with water
- \* Do not use a blower to dry the sweat on the massage chair
- \* Do not use gasoline, thinners, alkaline washing, bleach, etc

## Safety instructions

### Notice !

Please read all instructions before use. The massage chair must use a socket that matches the plug. Incorrect grounding will result in electric shock. Please do not change the plug and socket without permission. In the use of electrical products, in order to reduce the risk of electric shock, burns, or personnel injuries, basic safety precautions shall be observed, including the following:

Be sure to use the socket that matches the plug

Make sure the plug is completely plugged into the socket to reduce the risk of short circuits or fire

Please make sure the plug is removed before use

Do not use this product under high humidity

Do not store or use the product outdoors or in direct sunlight

If there is a sudden power failure during the operation, please switch the switch to the off position immediately and unplug the plug so as not to damage the product when you call

Do not operate massage chairs if the wires are wet or damaged

Please do not use wet hands to insert and remove the plug so as to avoid accidents

When a child, a handicapped person or an invalid is near a massage chair or using a massage chair, someone must be there

This product can only be used for purposes described in this manual

Do not use non supplier supplied parts

Do not sit or jump on the leg stand so as not to cause damage

Do not attempt to sit on the arm or back so that the massage chairs do not fall and cause accidents

Do not enter the sleeping state during the massage

Always keep the massage chair clean and avoid inserting other objects into the gap of the massage chair

Do not move the massage chair directly by pulling the power cord

Make sure that there is no other object under the lower leg or back, especially the child

Please check the seat back, lint and so on before each use. Are there any unusual cracks?.

If abnormal, please do not use and contact the supplier after sales service center

This product is designed for home use only

Consult a physician when you are unsure if you can use a massage chair

## Installation instructions

### Manual mode





Roller switch: Choose to turn on the roller mode or turn off the roller massage

Roller speed: Select the speed of the roller to massage the soles of the feet strong moderate weak

Heating switch: Turn on the back, heating or turn off the back

Vibration switch: Choose to turn on the hips or close the hips

### Keyboard

-  Long press, backrest rises
-  Long press, backrest down
-  Heating switch
-  Pause button
-  Press button, zero gravity mode



## Product structure

### Main body (front) of massage chair

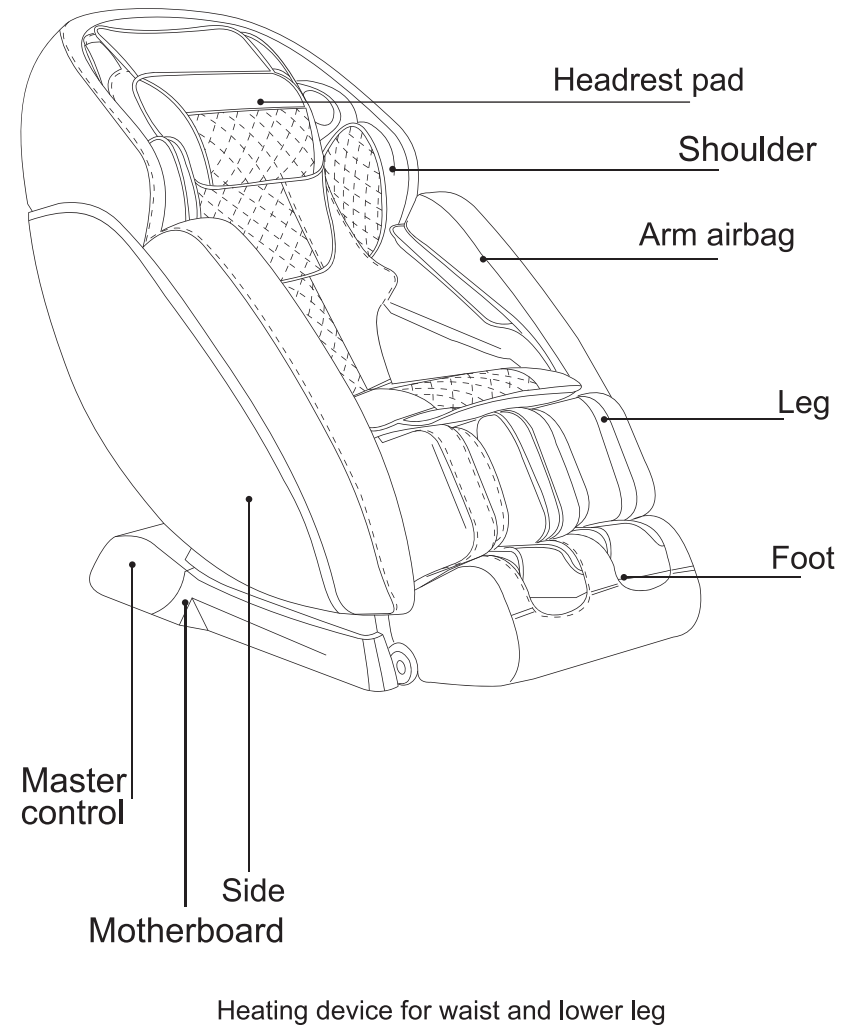

## Product mix

### Main body (back) of massage chair

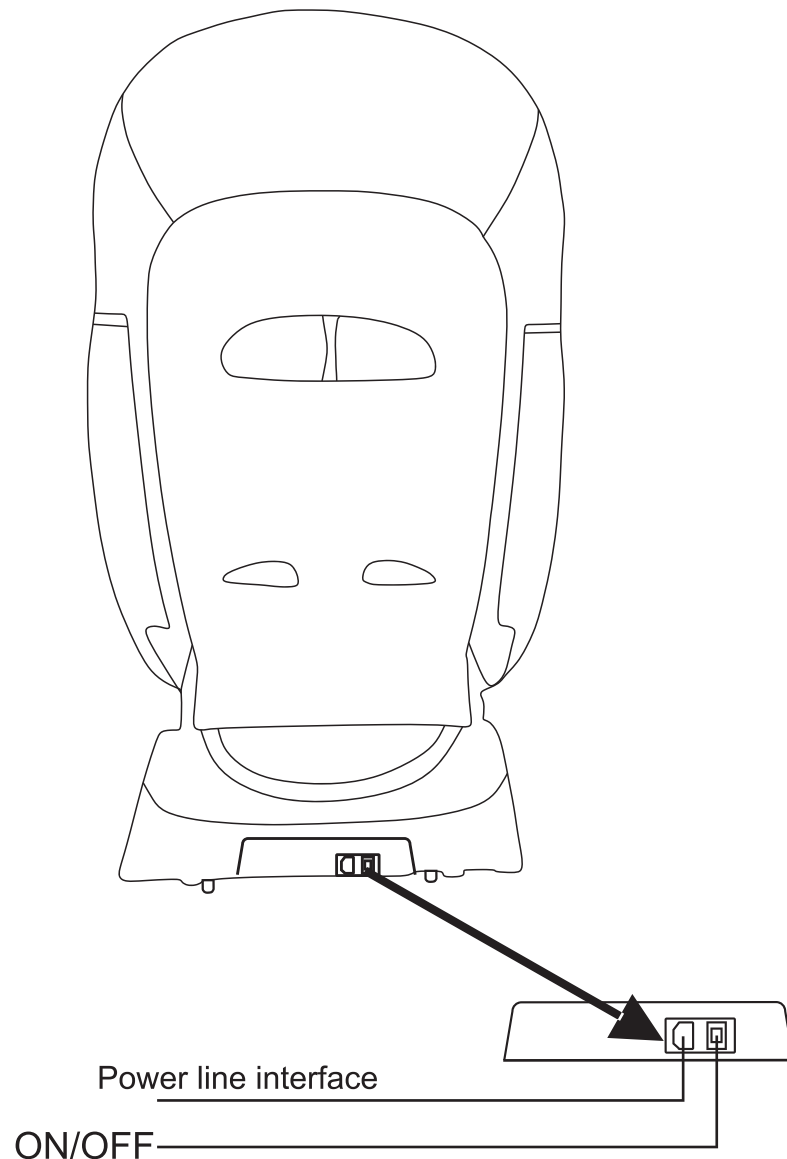

## Operation instructions

### Auto mode

 key or the automatic program that chooses to enter the menu interface

A total of 6 automatic modes are available for customers to choose the desired massage

Lumbar stretching in massage can be arbitrarily switched

Fatigue recovery

Pain relief

Sleep mode

Relaxation of tendons and collaterals

Neck and shoulder relaxation

### Manual mode

Manual programs entering the menu interface

\* Massage technique

Beat, knead, clap, strike, press finger, knock

\* Massage speed

Strong, moderate, weak

\* Massage range

Adjust the position of the massage head,

wide, moderate, narrow

\* Massage site

Choose where to massage

fixed point, Whole body, shoulder, Waist

## Operation instructions

### Remote control button function description

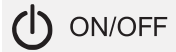

Press "open key" and enter auto mode by default



Press the menu key to enter the interface. Press the up and down keys to select automatic program, airbag program, manual program, other functions, roller speed and other settings

### Switching mode

#### AUTO

In automatic mode, you can also switch to other automatic mode (  ) and manual mode without massage until the end of an automatic program.

In automatic mode, you can also choose to turn on or off, air pressure, heating, rolling and other operations. In the LCD screen, the corresponding icon flashes, belongs to the current massage program

#### Manual mode

When you wait until an automatic program is finished, you can also switch to other automatic modes in the massage

## Product installation

Open the packing box and take out the parts

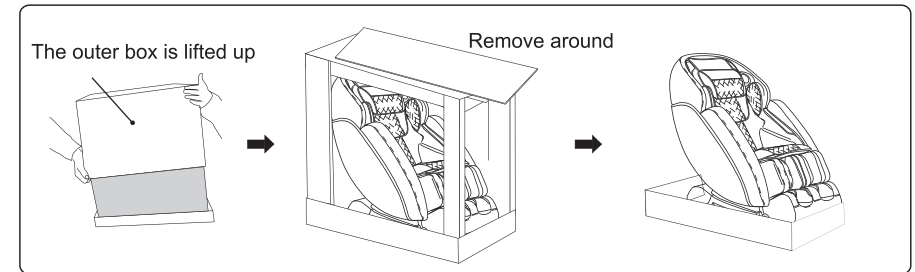

This machine is fully packed and free from technical installation

## Product installation

### Place massage chairs

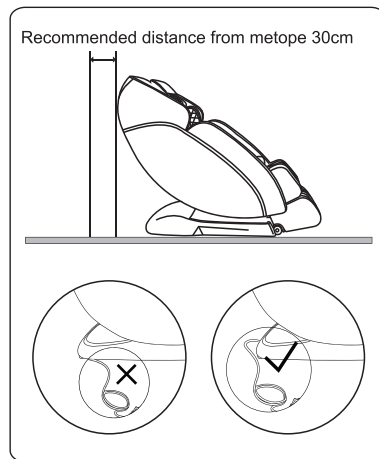

Lift the whole massage chair out of the bottom box and place it in the right place  
 When placing the massage chair, be sure to leave 30cm space on the back of the chair. Leave 55cm space in front of the chair so that the legs and backrest of the massage chair can be freely dumped

- \* Do not put the power cord in the electric control box of the massage chair
- \* In order to prevent ground damage and reduce noise, please put the cloth under the massage chair and so on

### Mobile massage chair

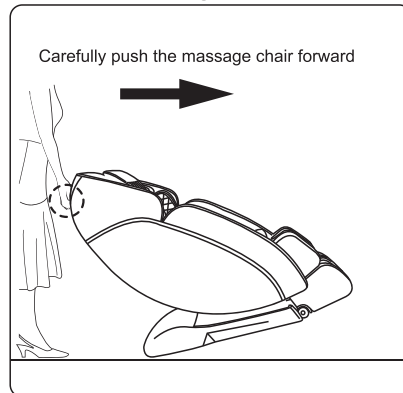

As shown in the first with both hands on the chair backrest, dumped back 45 degrees, by carefully pushing backward or forward casters massage chair, until the right down position

When someone is lying in a massage chair, do not move the massage chair  
 It may damage the floor when moving the massage chair. It is recommended to lower the mattress on this product  
 In order to avoid falling, please firmly hold the massage chair when you move the massage chair

## Remote control

### Remote control function zone: remote controller from

