

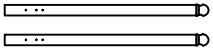

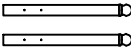

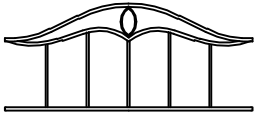









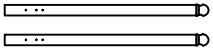
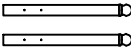
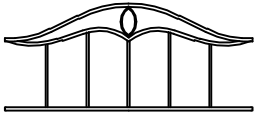

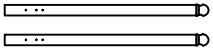
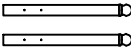
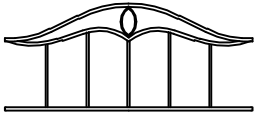

# Parts List

HEADBOARD CARTONS																			
<p><b>POST BOX</b>                      (1) HEADBOARD POST-2</p> <p>PART HARDWARE FOR GRILLS ATTACHMENT                      (5) 6MM X 90MM FLAT ALLEN HEAD SCREW-4                      (7) 4MM ALLEN WRENCH-1</p>	<table border="1"> <tr> <td style="text-align: center;">1</td> <td style="text-align: center;">2</td> </tr> <tr> <td style="text-align: center;">  </td> <td style="text-align: center;">  </td> </tr> <tr> <td colspan="2" style="text-align: center;">3</td> </tr> <tr> <td colspan="2" style="text-align: center;">  </td> </tr> <tr> <td style="text-align: center;">5</td> <td style="text-align: center;">6</td> <td style="text-align: center;">7</td> <td style="text-align: center;">8</td> <td style="text-align: center;">9</td> </tr> <tr> <td style="text-align: center;">  </td> <td style="text-align: center;">  </td> <td style="text-align: center;">  </td> <td style="text-align: center;">  </td> <td style="text-align: center;">  </td> </tr> </table>	1	2			3				5	6	7	8	9					
1	2																		
																			
3																			
																			
5	6	7	8	9															
																			
<p><b>GRILLS BOX</b>                      (3) HEADBOARD GRILL-1</p> <p>PART HARDWARE FOR FRAME ATTACHMENT                      (5) 6MM X 90MM FLAT ALLEN HEAD SCREW-4                      (8) 6MM ID X 10MM OD FLAT METAL WASHER-8                      (9) 6MM HEX NUTS-4                      (7) 4MM ALLEN WRENCH-1</p>																			

SAVE ALL PACKAGING MATERIALS UNTIL PRODUCT IS FULLY ASSEMBLED. HARDWARE AND SMALL PIECES MAY NOT BE SEEN AND COULD BE ACCIDENTALLY DISCARDED WITH PACKAGING MATERIALS.

## PRODUCT FULLY ASSEMBLED

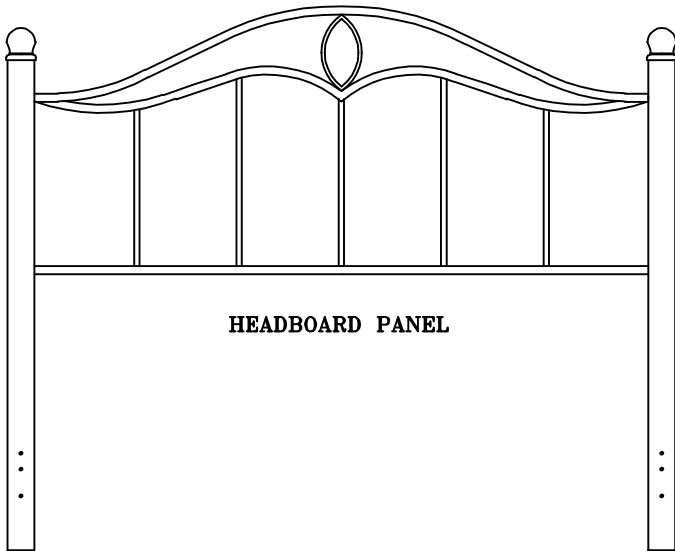

# Instruction Sheet

FIGURE 1

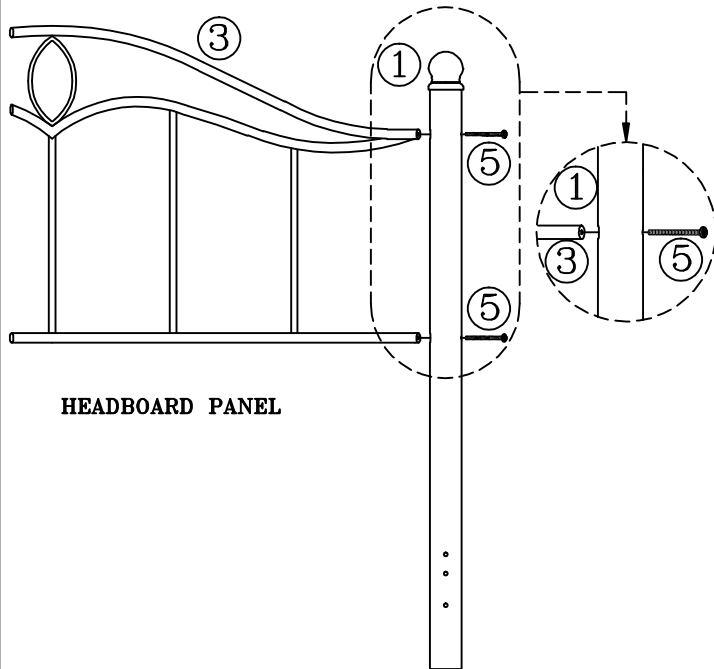

HEADBOARD PANEL

FIGURE 3

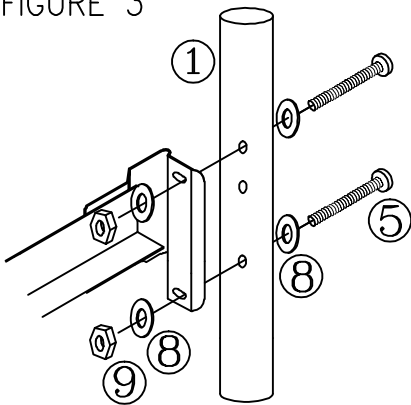

## STEP 1- Assembly of Headboard Panel.

- Align headboard grill (3) rail ends with holes in headboard post (1). SEE FIGURE 1
- Secure post (1) to headboard grill (3) with screw (5). Finger tight screws.
- Repeat on other side of headboard panel.
- Tighten all screws (5) securely using the Allen wrench (7).

## STEP 3- Assembly of Headboard Panel to Frame.

- Place headboard panel and frame in desired location in room.
- Insert flat metal washer (8) on screw (5).
- Insert screw through holes on headboard post (1). SEE FIGURE 3
- Align bed frame bracket over screws
- Place a flat metal washer (8) first and then a hex nut (9). Finger tighten DO NOT TIGHTEN SCREWS COMPLETELY
- Repeat on other side of headboard.
- Tighten all screws (5) securely using Allen wrench (7).

FOR ASSISTANCE IN ASSEMBLY ONLY OF THIS PRODUCT. CALL OUR HELP DESK . PLEASE

HAVE THE STYLE NUMBER AVAILABLE BEFORE YOU CALL. (STYLE # OR NAME CAN BE FOUND ON PACKING CARTON OR SALES RECEIPT.) OUR PRODUCT IS INSPECTED TO ENSURE IT IS IN GOOD CONDITION. IF YOUR FURNITURE APPEARS TO HAVE BEEN DAMAGED IN SHIPMENT OR YOU ARE IN NEED OF REPLACEMENT PARTS PLEASE CONTACT THE DEALER FROM WHOM YOU PURCHASED THE PRODUCT.