

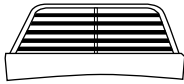





# Assembly Instruction

**Parts List:**

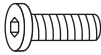
NO.	part	Diagram	Qty pcs
A	Chair Back		1
B	Seat Panel		1
C	Left Arm		1
D	Right Arm		1
E	Bolts	 M6*38mm	11
F	Washers		11
G	Seat Cushion		1
H	Back Cushion		1
I	Hex Wrench		1

For any missing or damaging parts, hardware, or any other problems, WELCOME to email us at: [SERVICE@RILYSON.COM](mailto:SERVICE@RILYSON.COM)  
Or 1-888-733-8169 Toll free  
Monday-Friday 9AM - 5PM EST

\* Don't fully tighten all the bolts till the very end!

**PRE-ASSEMBLY PREPARATION:**

--- Please read through the instructions before beginning assembly.

--- Clear out the space for assembly and lay out all of the parts based on the Parts List, extra room will allow you to easily determine if all the pieces are present.

--- Keep small parts and pieces away from children until fully assembled.

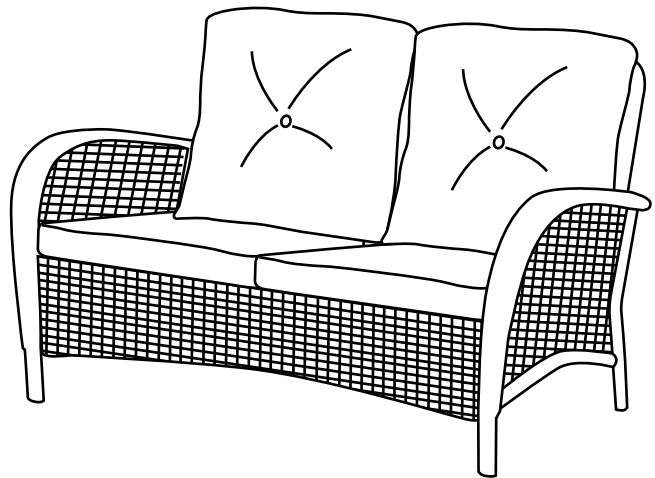

# Assembly Instruction

1>: B+C+D

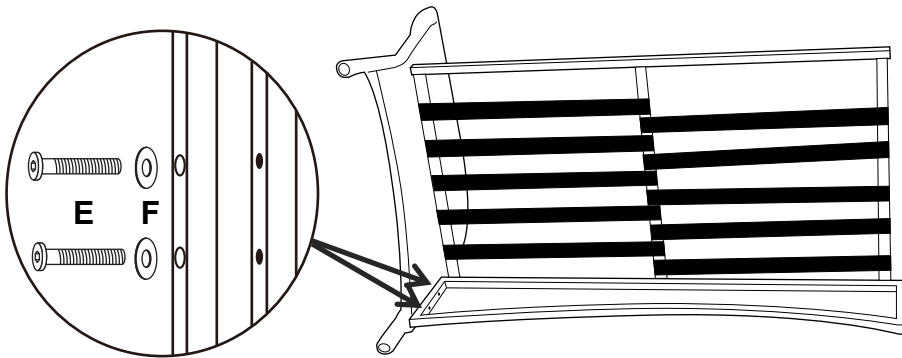

Attach left, right arms and seat panel with E and F. Don't tighten bolts!

3>: A+BCD

4>: ABCD

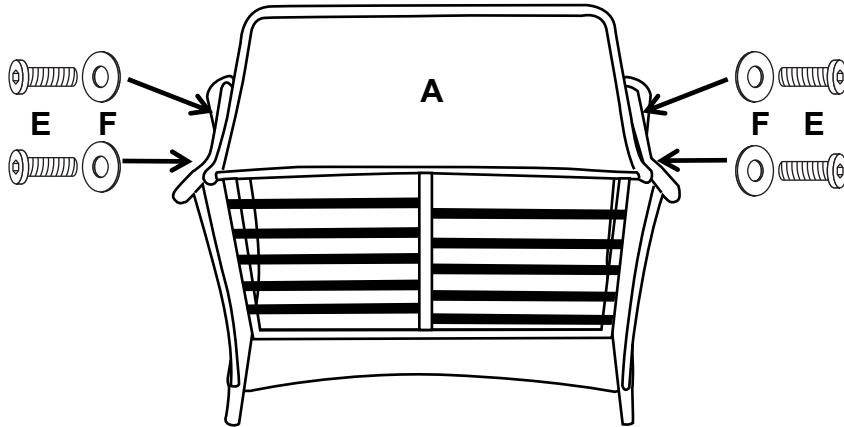

Attach left, right arms and back panel with E and F. Don't tighten bolts!

5>: ABCD

6>: ABCD+G+H

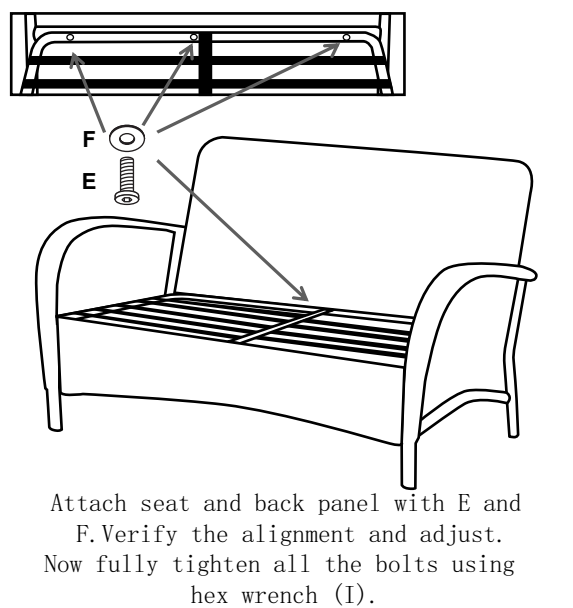

Attach seat and back panel with E and F. Verify the alignment and adjust. Now fully tighten all the bolts using hex wrench (I).

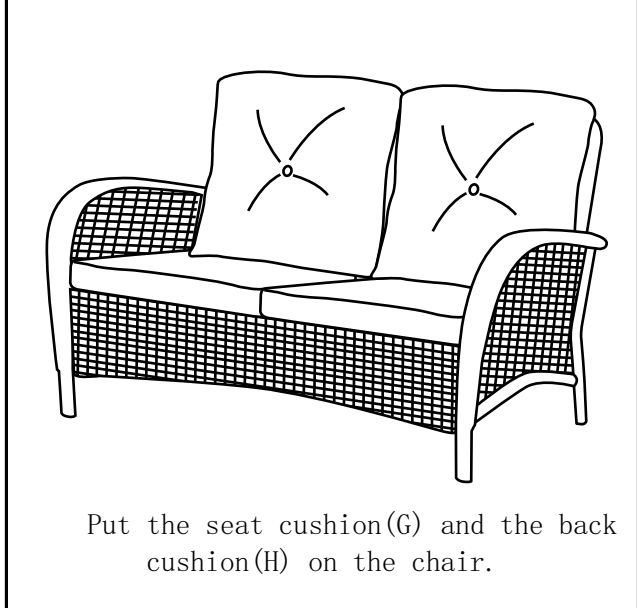

Put the seat cushion (G) and the back cushion (H) on the chair.

The chair is full assembled now.

# Assembly Instructions





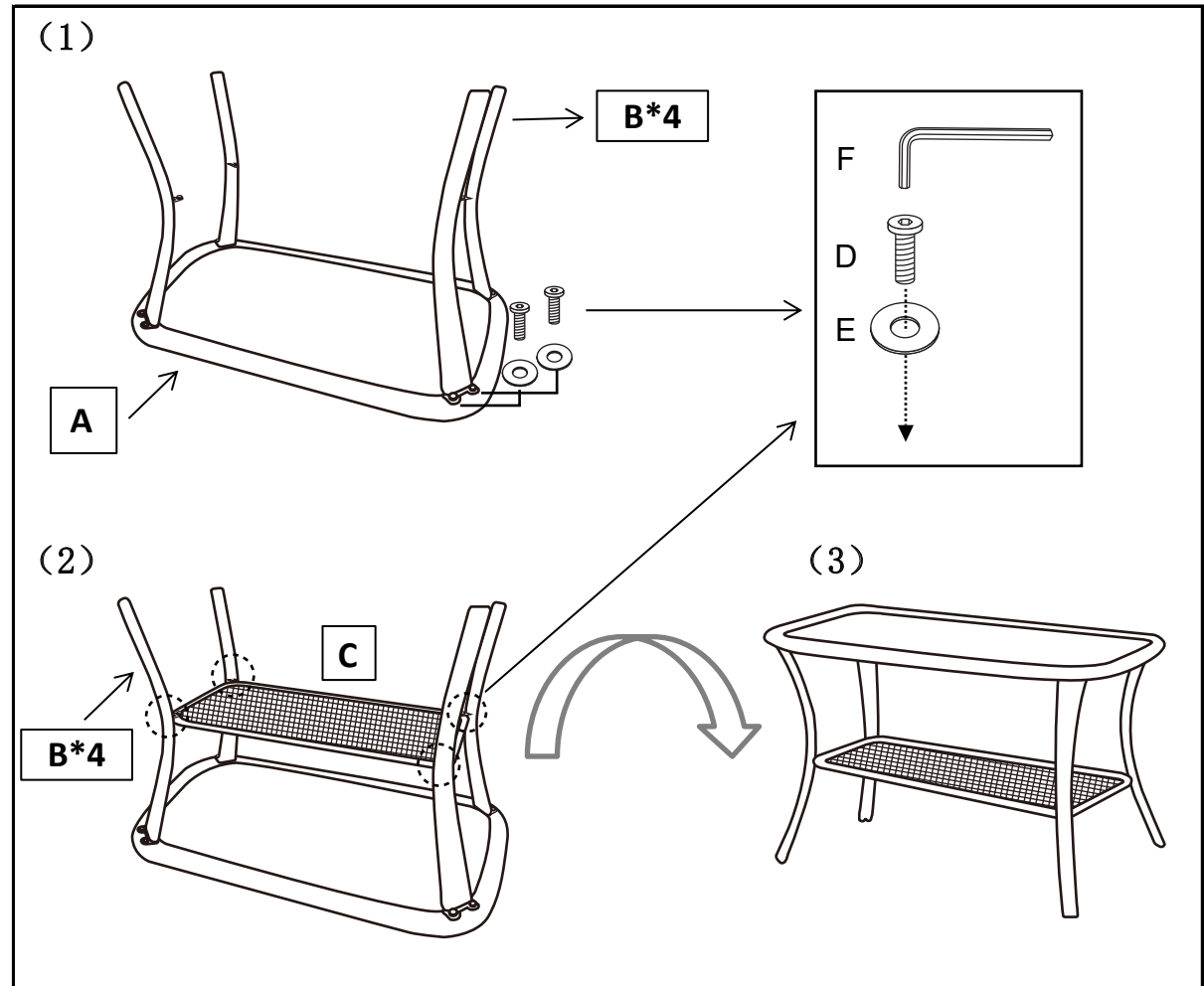

## Parts List(END TABLE):

NO.	part	Diagram	Qty pcs
A	Table Top		1
B	Table Leg		4
C	Table Shelf		1
D	Screws		12
E	Washers		12
F	Hex Wrench		1

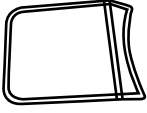
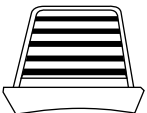

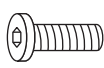
# Assembly Instruction

## Parts List:

NO.	part	Diagram	Qty pcs
A	Chair Back		1
B	Seat Panel		1
C	Left Arm		1
D	Right Arm		1
E	Bolts	 M6*38mm	10
F	Washers		10
G	Seat Cushion		1
H	Back Cushion		1
I	Hex Wrench		1

For any missing or damaging parts, hardware, or any other problems, WELCOME to email us at: [SERVICE@RILYSON.COM](mailto:SERVICE@RILYSON.COM)  
Or 1-888-733-8169 Toll free  
Monday-Friday 9AM - 5PM EST

\* Don't fully tighten all the bolts till the very end!

### PRE-ASSEMBLY PREPARATION:

- Please read through the instructions before beginning assembly.
- Clear out the space for assembly and lay out all of the parts based on the Parts List, extra room will allow you to easily determine if all the pieces are present.
- Keep small parts and pieces away from children until fully assembled.

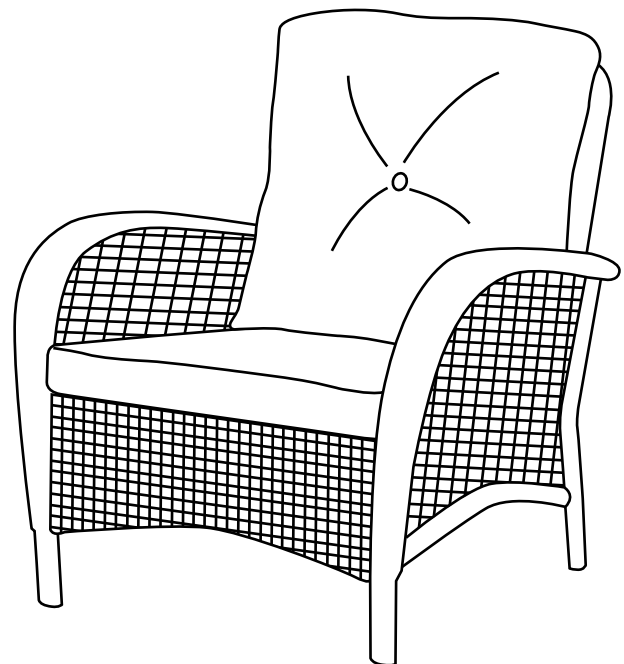

# Assembly Instruction

1>: B+C+D

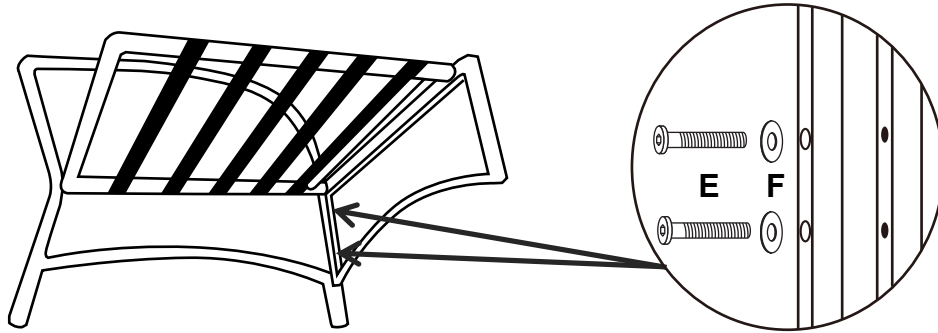

Attach left, right arms and seat panel with E and F. Don't tighten bolts!

2>: A+BCD

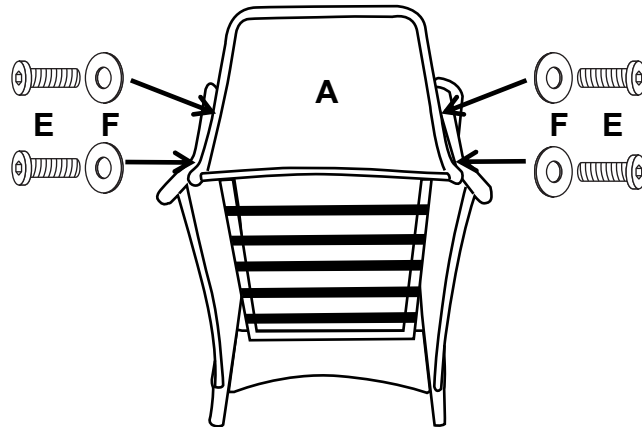

Attach left, right arms and back panel with E and F. Don't tighten bolts!

3>: ABCD

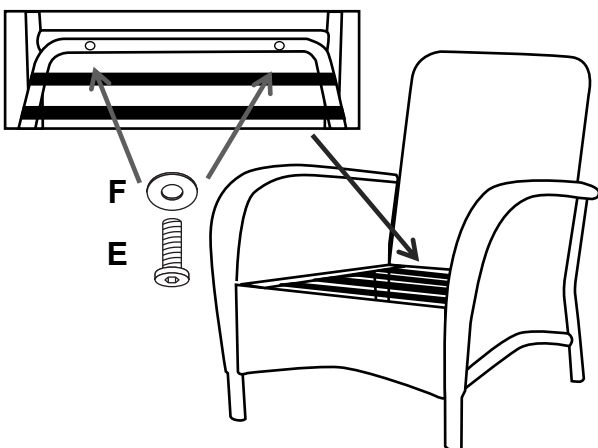

Attach seat and back panel with E and F. Verify the alignment and adjust. Now fully tighten all the bolts using hex wrench (I).

4>: ABCD+G+H

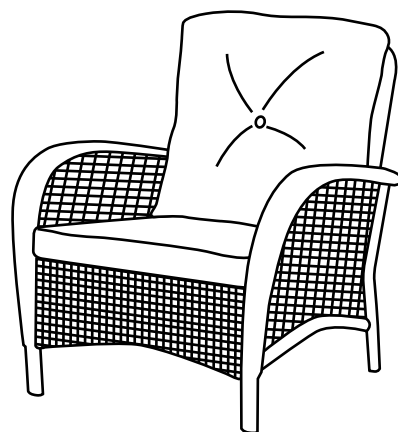

Put the seat cushion (G) and the back cushion (H) on the chair.

The chair is full assembled now.