

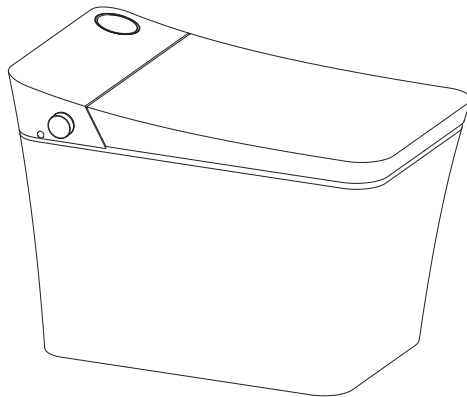

# Smart Toilet

## Manual



Model: BR30001AACH1W

Phone: 888-257-3857

Website: [www.casainc.com](http://www.casainc.com)

Customer Service: [service@casainc.com](mailto:service@casainc.com)



## **Thank you for your trust**

Sincerely thanks for buying our product, please understand important matters regarding the instructions for use from this manual before you use the product.

Please follow the instructions of the manual.  
Please safekeep the manual after reading for review later.

Our products will be improved continually, we will not notice if there's some change.

The pictures in the manual are schematic diagram only, please refer to the actual product for details.

We hope that you can master the instructions for use through this manual.

To make sure the best function provided by the product and personal safety, please:

**Read the manual carefully before the first time using.**

# Content

1. Overview	1
1.1 Appearance	1
1.2 Remote control	2
2. Packing list	3
3. Explanation of symbols	4
4. Safety instructions	4
4.1 Normal use	4
4.2 Safety instructions	4
4.3 The use of battery	6
5. Side button description	7
6. Remote control description	8
7. Other functions	11
8. More humanized design	13
9. Installation	14
9.1 Precautions before installation	14
9.2 Installation steps	15
9.3 Remote installation	20
9.4 Checklist after installation	21
10. Cleaning and maintenance	22
11. Product specification	24
12. Troubleshooting guide	25

# 1. Overview

## 1.1 Appearance

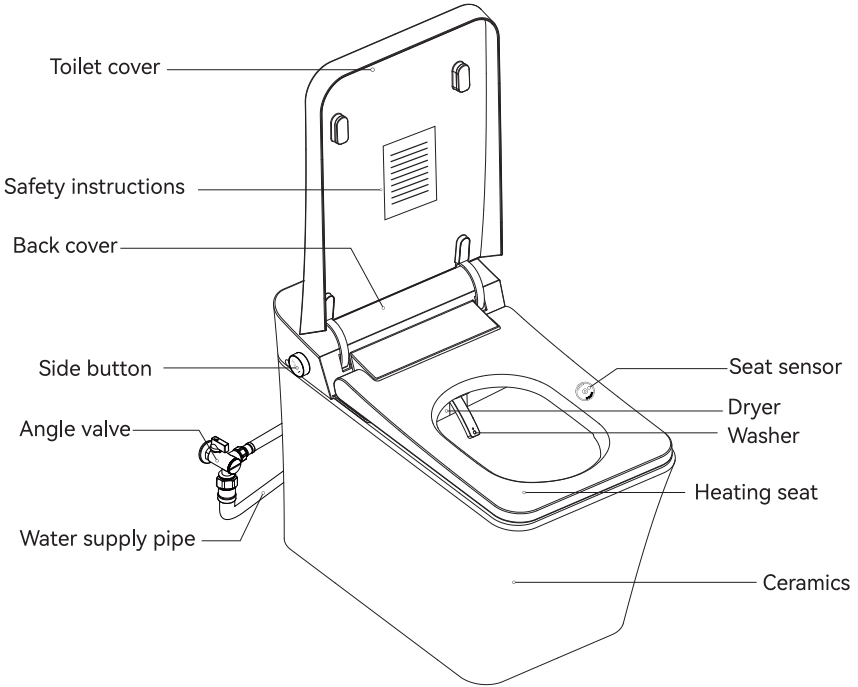

## ■ Side Button Description

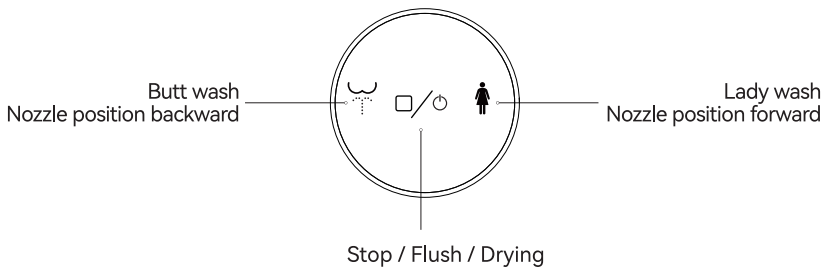

**Note:** | Regarding the appearance & function, please refer to the physical goods.

## 1.2 Remote

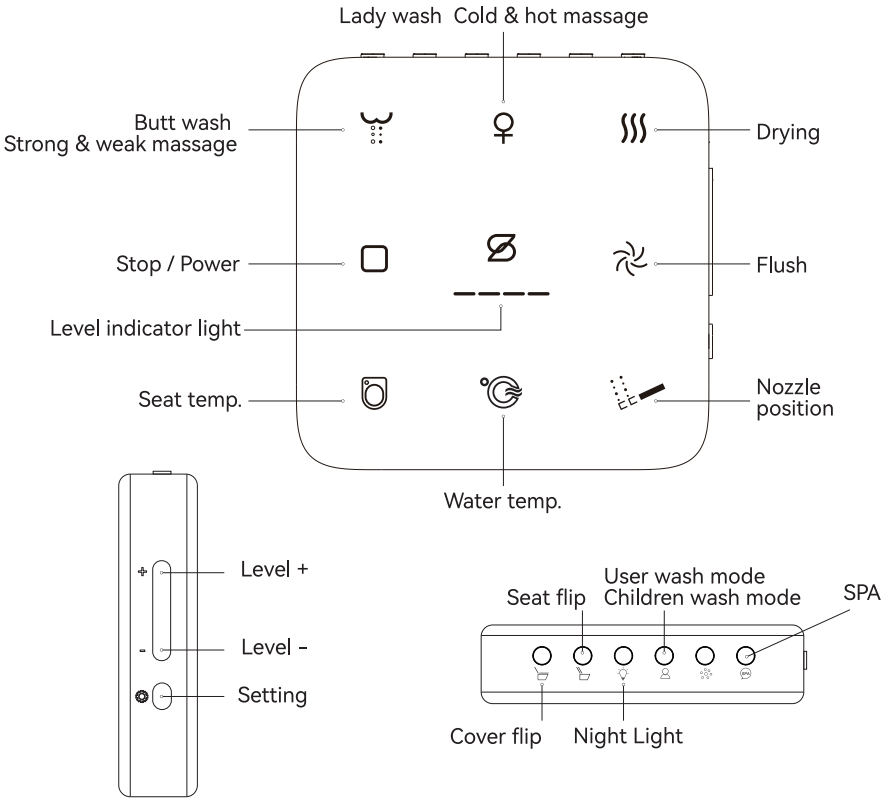

## ■ Pairing the remote

<p>press and hold the Drying button</p> <p>Level indicator light flashes</p> <ol style="list-style-type: none"> <li>1. Pull out the power plug, press and hold the Drying button until the level indicator light starts flashing, and then release the Drying button.</li> </ol>	<ol style="list-style-type: none"> <li>2. Hold the remote close to the toilet, and then insert the power plug.</li> </ol>	<ol style="list-style-type: none"> <li>3. When the level indicator light stops flashing and stays on, pairing succeeds.</li> </ol>
<p><b>Tips:</b> Do not keep it close to your body for whom has cardiac pacemaker and other auxiliary medical equipment in the body, Because the remote has strong magnet inside.</p>		

## 2. Packing list

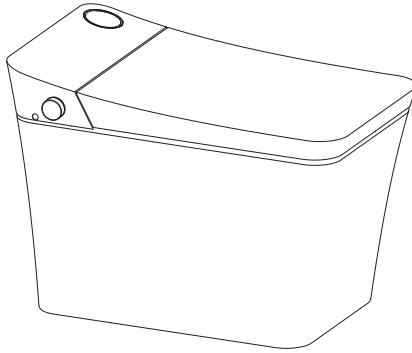

Complete machine

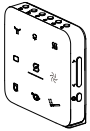

Remote

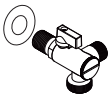

Angle valve filter  
& decorative cover

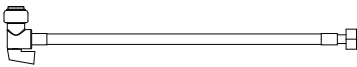

Quick lock valve



Remote battery

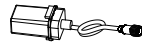

Backup battery





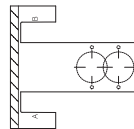





Wax ring



Positioning plate  
for ceramic body

Manual

### 3. Explanation of symbols

- |     |   |                |   |
|-----|---|----------------|---|
| 3.1 |  | <b>DANGER</b>  | Express that you will be dead or seriously injured if not avoid the dangerous situation.            |
| 3.2 |  | <b>WARNING</b> | Express that you will be dead or seriously injured if not avoid the dangerous situation.            |
| 3.3 |  | <b>CAUTION</b> | Express that it may cause personal injury or property damage if you ignore the sign and misoperate. |
| 3.4 |  |                | Do not add foreign matter such as water or detergent to the product body.                           |
| 3.5 |  |                | Do not disassemble the product privately.   |
| 3.6 |  |                | Keep away from fire.  |
| 3.7 |  |                | Please operate according to the manual.   |
| 3.8 |  |                | It's forbidden.   |

### 4. Safety instructions

Please read the manual carefully, especially the safety instructions in order to make sure you can enjoy the service of the product. Please reserve the manual carefully. Please attach the manual if you send the product to others.

#### 4.1 Normal use

This product is a one-piece intelligent toilet with integrated flushing system. It can comfortably clean the buttocks and private place which is used only for closed space. Any other use is considered as abnormal use. For abnormal use, we will not assume any responsibility.

#### 4.2 Safety instructions

Please read and follow the safety instructions as below!

##### Requirement of user

- For disabled, defective people in physical, sensory perception and intellectual abilities, and people who is lack of experience and common sense ( including children ), please use this product under supervision.
- Don't allow children to play with this product.

##### **DANGER**

- Please make sure that the ground wire has been connected.
- If the ground wire is not connected, it may cause electric shock or leakage.
- Make sure the power cord is not damaged.
- The power cord can't be stucked or squeezed.
- Keeps the power cord away from hot surfaces and sharp edges.
- The power socket must be within the specified range ( AC120V  $\pm$ 10% ).

## DANGER

- Do not use it in thunder weather. ( Please Pull out the power plug in thunder weather. )
- Do not pull the power cord at random, break forcibly bend and twist, stretch, curl, bundle,load or over-clamp.
- Do not touch or plug and unplug the power plug with wet hands, otherwise there will have danger of electric shock.
- Do not use it when it can't work normally. Disconnect power immediately, close the angle valve to cut off the water source and ask for help from professional repair man.

## WARNING

Avoid product ailure and damage caused by improper use.

The cold water of the intelligent electronic toilet should be connected from the main water supply pipe. Do not connect any wastewater, mixed water, industrial water, sea water or other untreated or semi-treated water.

- If the product is moved from a lower temperature position to a higher temperature place, it may have condensate water. Please turn off the product for several hours at this time.
- Do not install this product in a room where may be frosted. The room temperature can't be less than 39.2 °F.
- Do not put fire, candles, cigarette butts or similar items on this product.
- Do not soak the product in water or expose it to the sun.
- Do not attempt to flush debris other than human waste and toilet paper.
- Do not lean on the back cover, climb or stand on the product.
- Do not put any heavy objects on the cover.
- Repair work must be performed by relevant professionals.
- Do not disassemble the back cover, cover and seat.
- Do not modify, retrofit or repair the product.
- Incorrect repair may cause accidents, damage or operational failure.
- If the power cord is damaged, don't disassemble it by yourself. It must be replaced by the manufacturer or the repair department or a similar professionals.
- When do the cleaning and maintenance of the plastic part, please do not use unsuitable detergent(such as Sulfuric acid, nitric acid, acetic acid, carbon cyanide, chloroform, acetone, methyl ethyl ketone, benzene, hydrochloric acid, nitric acid, steam kerosene etc. )
- Please cut off the power when cleaning the product and the remote. Don't pour water or detergent into the product.
- Avoid to use this product in an environment which is humid and easily touched bywater .Don't spray water to the product. Don't rinse this product with water.
- Don't block the air outlet. Don't put your hands or other things into the air outlet.
- Don't cover the air outlet when using it.
- Don't shoot urine into the air outlet.
- Do not put ignited cigarettes and other burning materials into this product.

## 4.3 The use of battery

If there's leakage of battery liquid, please do not let the skin, eyes and mucosa to be touched by the battery liquid. If you touch the liquid carelessly, please rinse the infected part immediately with mass water and go for a doctor immediately.



### WARNING









- Please put the battery out of the reach of kids. It will be life threatening if swallowing the battery. Please request medical immediately if the battery has been swallowed.
- Do not charge the battery. It is forbidden to reactivate and disassemble the battery or put it into fire.
- Please get out the battery from the remote after running out of power . Otherwise the liquid may leak and cause damage.
- Clean the battery and contacts before assemble the battery. Pay attention to the battery polarity to be assembled in correct position during installation.
- Please take out the battery and save it correctly if the remote is not used.
- Do not keep the battery in extreme environment. Do not touch the heat source or expose to the sun, otherwise it may cause leakage.
- Do not carry and store the battery with metal products.























### CAUTION

























- Do not use excessive force when closing the cover and seat .
- Do not intentionally soil, spray or block the cleaning nozzle.
- Please pull out the plug regularly and wipe the dust from the power plug with a dry cotton cloth.
- Keep the skin close to the seat sensor when use it, otherwise the product will stop cleaning or drying function. Children should seat back to touch the seat sensor.
- Please use the new hose parts attached with the product, the old one can't be reused.
- Please avoid closing to the heater.
- Do not connect to the power through the external switch to avoid danger from accidental resetting of the circuit breaker, such as a timer or a timed on/off circuit that is connected by a common component.
- Please close the angle valve before disassembling the filter. Be sure to tighten the angle valve to prevent water leakage when installing the filter after cleaning.
- When you will not use this product for a long time, such as going out for a business trip or travelling, be sure to pull out the power plug, turn off the water and drain the remaining water inside the product.
- The remaining water may freeze when the product is transported over long distances or stored for a long time in cold winter or alpine region. To prevent the damage caused by freezing, please take antifreeze measures.

















## 5. Side button description

		
FUNCTION	ICON	OPERATION
Stop / Power Flush / Drying		<b>Power switch: long press for power on/off</b> <ul style="list-style-type: none"> <li>When power is off, long pressing for over 2 seconds will turn it on.</li> <li>When power is on, long pressing for over 2 seconds will turn it off.</li> </ul>
		<b>Short pressing the button [ □/○ ] will stop any ongoing function.</b> <ul style="list-style-type: none"> <li>It can stop any ongoing functions like butt wash, lady wash, personalized wash, nozzle cleaning, drying function, etc.</li> </ul>
		<b>When the human body is seated and the toilet is in static, short pressing the button [ □/○ ] will start the drying function.</b> <ul style="list-style-type: none"> <li>When the drying function is open, it will blow warm wind with the level of temperature in memory.</li> <li>The warm wind will stop automatically after 5 minutes' blowing.</li> </ul>
		<b>When power is on and in standby, short pressing the button [ □/○ ] will start the flushing function.</b> <ul style="list-style-type: none"> <li>Pressing it again is invalid when it is flushing.</li> </ul>
		<b>The light features of side button:</b> <b>When the human body leaves seat:</b> <ul style="list-style-type: none"> <li>If energy saving mode is open, the button light turns green.</li> <li>If energy saving mode is closed, the button light turns white.</li> </ul> <b>When the human body is seated:</b> <ul style="list-style-type: none"> <li>If drying is ongoing, the button light turns yellow.</li> <li>If butt wash is ongoing, the button light turns blue.</li> <li>If lady wash is ongoing, the button light turns red.</li> </ul>
Butt wash / Nozzle backforward		<b>When the human body is seated:</b> <ul style="list-style-type: none"> <li>Rotating up the button [  ] will start butt wash function, and reciprocating wash will begin with the levels of water temperature, nozzle position and water pressure in memory, for 90 seconds' cleaning.</li> <li>The factory settings for butt wash function are all in the mid level of nozzle position, water pressure and water temperature.</li> </ul>
		<b>Nozzle position adjustment</b> <ul style="list-style-type: none"> <li>When the wash function is ongoing, rotating up the button [  ] will move the nozzle backward.</li> <li>There are 4 levels for adjustment, close, low, mid, high level. If it is out of levels, the machine will respond with two beeps telling the operation is invalid. (The correct operation only has one beep).</li> </ul>
Lady wash / Nozzle forward		<b>When the human body is seated:</b> <ul style="list-style-type: none"> <li>Rotating down the button [  ] will start lady wash function, and reciprocating wash will begin with the levels of water temperature, nozzle position and water pressure in memory, for 90 seconds' cleaning.</li> <li>The factory settings for lady wash function are all in the mid level of nozzle position, water pressure and water temperature.</li> </ul>
		<b>Nozzle position adjustment</b> <ul style="list-style-type: none"> <li>When the wash function is ongoing, rotating down the button [  ] will move the nozzle forward.</li> <li>There are 4 levels for adjustment, close, low, mid, high level. If it is out of levels, the machine will respond with two beeps telling the operation is invalid. (The correct operation only has one beep)</li> </ul>













## 6. Remote Control Functions and Icons Description

FUNCTION	ICON	OPERATION
Butt wash / Reciprocating wash / Strong & weak massage		<p>When the human body is seated, short pressing the button 【】 will start butt wash function.</p> <ul style="list-style-type: none"> <li>The nozzle reciprocating cleaning function is turned on by default. during cleaning, the nozzle moves forth and back to increase cleaning area. Short pressing it again to stop the reciprocating function.</li> <li>During washing, short pressing the button 【】 will stop the butt wash function.</li> </ul>
		<p>When the human body is seated and cleaning is ongoing, long pressing the button 【】 will start/stop strong&amp;weak massage washing function, with strong to weak water pressure changes to achieve massage effect.</p>
Lady wash / Reciprocating wash / Warm and cold massage		<p>When the human body is seated, short pressing the button 【】 will start lady wash function.</p> <ul style="list-style-type: none"> <li>The nozzle reciprocating cleaning function is turned on by default. During cleaning, the nozzle moves forth and back to increase cleaning area. short pressing it again to stop the reciprocating function.</li> <li>During washing, short pressing the button 【】 will stop the butt wash function.</li> </ul>
		<p>When the human body is seated and cleaning is ongoing, long pressing the button 【】 will start/stop hot&amp;cold massage washing function, The water temperature starts to change from hot to cold to achieve the massage effect.</p>
Warm drying / Air temperature adjustment		<p>When the human body is seated, short pressing the button 【】 will start drying function.</p>
		<p>When the human body is seated, short pressing the button 【】 will start wind temperature adjustment.</p> <ul style="list-style-type: none"> <li>Press 【level +】 button, the temperature will rise.</li> <li>Press 【level -】 button, the temperature will drop.</li> <li>The seat temperature adjustment has four levels: daily temp, low temp, mid temp, high temp. And the corresponding level indicator light will be bright.</li> </ul>
Auto drying setting		<p>Press and hold the 【】 button, then press the 【】 button to open/close auto drying setting. A short beep means setting is closed, and a long beep means setting is open.</p> <ul style="list-style-type: none"> <li>If the setting is closed, it won't automatically switch to the drying function after cleaning is completed.</li> <li>If the setting is open, it will automatically switch to the drying function after cleaning is completed.</li> </ul>
Stop / Power		<p>Short pressing the button 【】 will stop any ongoing function.</p>
		<p>Power switch: long press for power on/off.</p> <ul style="list-style-type: none"> <li>When power is off, long pressing for over 2 seconds will turn it on.</li> <li>When power is on, long pressing for over 2 seconds will turn it off.</li> </ul> <p>When power is off, shutdown mode exits automatically at the time the human body sits on the seat.</p>
Level indicator light		
Flushing		<p>Short press the button 【】 to start flushing.</p>

FUNCTION	ICON	OPERATION
Seat temperature adjustment		<p>Press the button <b>【】</b> into the mode of seat temperature adjustment.</p> <ul style="list-style-type: none"> <li>● Press <b>【 level + 】</b> button to increase the temperature.</li> <li>● Press <b>【 level - 】</b> button to decrease the temperature.</li> <li>● The seat temperature adjustment has four levels, daily temp, low temp, mid temp, and high temp level. The corresponding level indicator light will be bright.</li> </ul>
Water temperature adjustment		<p>Press the button <b>【】</b> into the mode of water temperature adjustment.</p> <ul style="list-style-type: none"> <li>● Press <b>【 level + 】</b> button to increase the temperature.</li> <li>● Press <b>【 level - 】</b> button to decrease the temperature.</li> <li>● The water temperature adjustment has four levels, daily temp, low temp, mid temp, and high temp level. The corresponding level indicator light will be bright.</li> </ul>
Nozzle position adjustment		<p>When the wash function is ongoing, press <b>【】</b> button into the mode of nozzle position adjustment.</p> <ul style="list-style-type: none"> <li>● Press <b>【 level + 】</b> button to move the tube position forward.</li> <li>● Press <b>【 level - 】</b> button to move the tube position backward.</li> <li>● The nozzle position adjustment has four levels, close, low, mid, high. the corresponding level indicator light will be bright.</li> </ul>
Water pressure adjustment		<p>When the wash function is ongoing, press the button <b>【】</b>, come into the mode of water pressure adjustment.</p> <ul style="list-style-type: none"> <li>● Press the <b>【 level + 】</b> button to increase the cleaning intensity.</li> <li>● Press the <b>【 level - 】</b> button to reduce the cleaning intensity.</li> <li>● The water pressure adjustment has four levels, close, low, mid, high.</li> <li>● If it is out of level, the machine responds with two beeps telling the operation is invalid.(The correct operation only has one beep.)</li> </ul>
Setting		<p>The key for setting various functions.</p>
Level adjustment		<p>Key for adjusting levels of various functions.</p>
Open & close cover / Auto setting		<p>Press the <b>【】</b> button to open/close the cover</p> <ul style="list-style-type: none"> <li>● If the seat is open, pressing the <b>【】</b> button will close the seat and the cover in sequence.</li> </ul>
	 	<p><b>Auto setting: press and hold the <b>【】</b> button, then press the <b>【】</b> button to open/close auto open &amp; close cover setting.</b></p> <p>A short beep means setting is closed, and a long beep means setting is open. The setting is open by default.</p> <ul style="list-style-type: none"> <li>● If the setting is open, it will automatically open the cover when the user approaches, and will automatically close the cover after the user leaves.</li> <li>● If the setting is closed, it won't automatically open or close the cover.</li> </ul>
Auto open & close seat / Auto setting		<p>Press the <b>【】</b> button to open/close the seat</p> <ul style="list-style-type: none"> <li>● If the cover is closed, pressing the <b>【】</b> button will open the cover and the seat in sequence.</li> </ul>
	 	<p><b>Auto setting: press and hold the <b>【】</b> button, then press the <b>【】</b> button to open/close auto open &amp; close seat setting.</b></p> <p>A short beep means setting is closed, and a long beep means setting is open. The setting is closed by default.</p> <p><b>It only works when auto open&amp;close cover setting is open.</b></p> <ul style="list-style-type: none"> <li>● If the setting is open, it will automatically open the cover and seat when the user approaches, and will automatically close the seat and cover after the user leaves.</li> <li>● If the setting is closed, it won't automatically open or close the seat.</li> </ul>

FUNCTION	ICON	OPERATION
Night light		<p><b>Turn on/off night light</b></p> <ul style="list-style-type: none"> <li>● press the button  on remote to turn on night light.</li> <li>● press again the button  on remote to turn off night light.</li> </ul>
Energy saving mode	 	<p>Press and hold the button  , then press the button  to turn on/off the energy-saving mode. When it turns on, the side knob shows green light. When it turns off, the side knob shows white light. The seat temperature will keep in the range of 77°F~96.8°F intelligently according to the change of environment temperature. If the seat temperature set by the user is lower than the intelligent setting temperature, it will keep the temperature set by the user. It will keep the temperature set by the user after exiting the energy saving mode.</p> <p><b>Note:</b> The energy saving fuction means to low down the seat temperature when nobody uses the toilet.</p>
Children wash		<p><b>Children wash</b></p> <p>When the user is seated, press and hold the  button for over 2 seconds, the nozzle will extend to the preset position starting to clean with the preset level of water temperature. It stops automatically after 90 seconds cleaning. This function presets the water pressure specially for children.</p> <p><b>Note:</b> during cleaning, water temperature, water pressure, nozzle position, oscillating spary and massage wash function can't be adjusted.</p>
Personalized user wash		<p>When the user is seated, press the  button to change to different users' setting one by one, and the nozzle will extend to spray with the set level of water temperature, water pressure and nozzle position. The indicator light shows the corresponding level, as four levels correspond to four users.</p> <p><b>Personalized user wash setting</b></p> <ul style="list-style-type: none"> <li>● When the personalized user wash starts, the user can directly adjust the water pressure, water temperature and nozzle position to reset, which will be saved in product's memory for the selected user.</li> </ul> <p>The user mode exits when remote control is in standby for some while.</p>
SPA		<p>When the human body is seated, pressing the button  will start the SPA function.</p> <ul style="list-style-type: none"> <li>● When the SPA function is open, it will start cleaning with the level of the wash function used last time, and start the strong &amp; weak massage and the hot &amp; cold massage function.</li> <li>● Short pressing the button  again will stop strong &amp; weak message and hot &amp; cold message.</li> <li>● Short press the button  to stop SPA cleaning.</li> <li>● After continuous cleaning for about 5 minutes, it will stop cleaning and start the drying function automatically.</li> </ul>
Foot sensor	 	<p><b>The foot sensor function can realize the following functions:</b></p> <ul style="list-style-type: none"> <li>● foot sensor for flushing</li> <li>● foot sensor for opening cover or seat</li> <li>● foot sensor for closing seat</li> </ul> <p><b>Key points of foot sensor for flipping cover and seat:</b></p> <ul style="list-style-type: none"> <li>● The foot needs to be placed within 2cm from the sensor, and then the foot-sensing action is effective.</li> </ul>

## 7. Other functions

FUNCTION	ICON	OPERATION
Water Replacement		<p>When the product has not been used for a long time, please firstly replace the inner water in storage of the toilet through this function. When the water is being replaced, it is normal to have water discharged under the baffle.</p> <ul style="list-style-type: none"> <li>● Long pressing 【  】 button will start the live water replacement function, and it will stop automatically after the replacement is completed.</li> <li>● Pressing 【  】 button will stop the ongoing live water replacement function.</li> </ul>
Nozzle self-cleaning		<p>When the human body leaves the seat, press the side button 【  】 or rotate up the knob for 2 seconds, the nozzle will extend and have water flowing out on its surface. Use a toothbrush coated with toothpaste to scrub the nozzle body and nozzle head, don't use too much strength. Press 【  】 button when cleaning is completed, and the nozzle will move back.</p>
Setting of sensing distance for cover/ seat flip	 + -	<p>Press and hold the button 【  】 , then press the button 【 level + 】 or 【 level - 】 into the sensing distance setting.</p> <ul style="list-style-type: none"> <li>● Press 【 level + 】 to increase the sensing distance.</li> <li>● Press 【 level - 】 to decrease the sensing distance.</li> </ul> <p>There are five levels of distance adjustment, first, second, third, fourth, fifth level. If it is out of levels, the machine will respond with two beeps telling the operation is invalid. (The correct operation only has one beep)</p> <p><b>This function is only available for models with cover and seat flip function.</b></p>
Automatic flushing	 	<p>Press and hold the button 【  】 , then press the button 【  】 to open or close the automatic flush setting.</p> <ul style="list-style-type: none"> <li>● When the setting is off, the machine responds with a short tone.</li> <li>● When the setting is open, the machine responds with a long tone.</li> </ul>
<p>■ When the automatic flushing setting is open, automatic flushing starts in situations as follows</p>		
1	<p><b>Automatic flushing before drying</b></p> <ul style="list-style-type: none"> <li>● When you use the drying function after using the cleaning function, it will automatically flush once before drying.</li> </ul>	
2	<p><b>Automatic flushing after the human body leaves the seat for over 5 seconds.</b></p> <ul style="list-style-type: none"> <li>● Automatic flushing will not be performed when the human body is seating. It will perform automatic flushing once after leaving the seat for about 5 seconds. (The seating time should be more than 6 seconds)</li> <li>● It will not automatically flush if the last function is drying when leaving the seat.</li> </ul>	
3	<p><b>Man leaves about 3 seconds after urinating, it will flush automatically</b></p> <ul style="list-style-type: none"> <li>● The cover and seat must be in the open state, then man urinates for over 10 seconds and leaves, and it will flush automatically after leaving for over 3 seconds.</li> </ul>	
<p>■ Manual flushing</p>		
1	<p><b>Short press the flush button on remote to flush.</b></p> <ul style="list-style-type: none"> <li>● It can flush by remote.</li> </ul>	
2	<p><b>When the power is on and in standby, short press the flush button on side panel to flush.</b></p> <ul style="list-style-type: none"> <li>● It can flush by short pressing the side button.</li> </ul>	
<p>■ Power-off flush</p>		
<p><b>When the product is not plugged in, or in the case of power failure, press the flush button on side panel to flush.</b></p> <ul style="list-style-type: none"> <li>● If the above operation is invalid, please replace the battery or contact your local dealer.</li> </ul>		

## ■ Sensing function description

### Automatic cover flip

- The cover flips automatically when people approach.

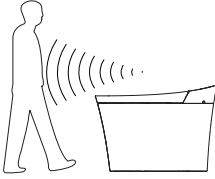

- The seat flips by foot sensor.

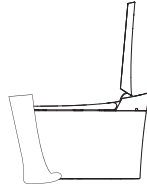

- Leave after using over 10 seconds

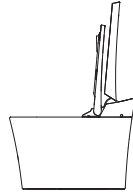

- Automatically flush after about 3 seconds.



- Automatically close the seat and cover after about 20 seconds.

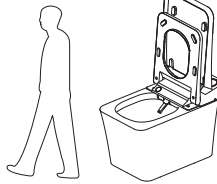
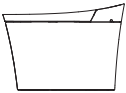

### Automatic cover flip and seat flip

- Automatically open the cover and seat when people approach.

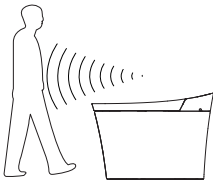

- The seat closes by foot sensor.

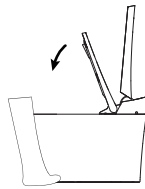

- Leave after sitting on seat over 10 seconds

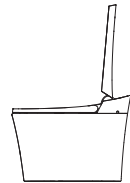

- Automatically flush before drying or after leaving the seat for about 3 seconds



- Automatically close the cover after about 20 seconds.

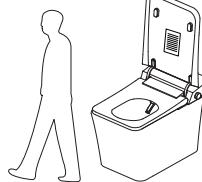
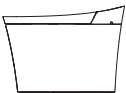

## 8. More humanized design

### ■ Damping slowing down

The product adds a damping function to make the seat and the cover falling smoothly to reach silent effect.

### ■ Water purification

The filter device purifies the water source to ensure the clean and hygiene when using.

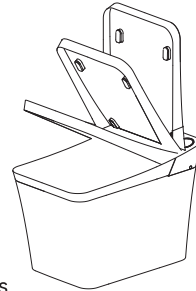

### ■ Eleven fold protection

The product has eleven safety protection measures including leakage protection to ensure the safe use of users.



Power leakage protection	Anti low temperature burning	Dry burning-resistant protection
Air temperature overheating protection	Seat temperature overheating protection	Water temperature overheating protection
Over-high water pressure protection	Frost crack protection	IPX4 water proof protection
Ground protection	Fire retardant protection (VO retardant protection)	

### ■ Energy saving mode

- The product will close after stand by for 36 hours to avoid wasting and concern. ( If toilet is in dormant state in energy saving mode, it can be activated by seating on seat sensor, long pressing the stop button on side panel, or long pressing the stop button on remote control ).
- Press and hold the button  , then press the button  to turn on/off the energy-saving mode. When it turns on, the side knob shows green light. When it turns off, the side knob shows white light. The seat temperature will keep in the range of 77°F~96.8°F intelligently according to the change of environment temperature. If the seat temperature set by the user is lower than the intelligent setting temperature, it will keep the temperature set by the user. It will keep the temperature set by the user after exiting the energy saving mode.  
**Note:** The energy saving function means to low down the seat temperature when nobody uses the toilet.

### ■ Deodorization

- The deodorization function starts after human body is seated. It stops after human body leaves the seat for around 60 seconds.
- When the human body is seated and function of cleaning or drying is not open, short press the button  to stop the deodorization function.

### ■ LED display / Light



The temperature display corresponds to the temperature level on the remote. When you're setting the different function's temperature, the corresponding function light will light. In the meanwhile, it displays the current temperature in the middle screen.

## 9. Installation

### 9.1 Precautions before installation

#### ■ Water pressure

1. Minimum static water pressure : 0.14MPa ( 1.4kg / cm<sup>2</sup> ).
2. Minimum water flow : more than 20L per minute.
3. Please make sure to meet the two conditions above when the toilet is used parallelly with faucet or other water equipment.

#### ■ Space and structure for installation

Please make sure opening and closing the door will not affect the installation and use of the toilet when you are checking the installation space is big enough or not. The distance of the inlet pipe from the ground should be more than 150mm. Before installation, please confirm the location of sewage outlet and wax seal as below picture.

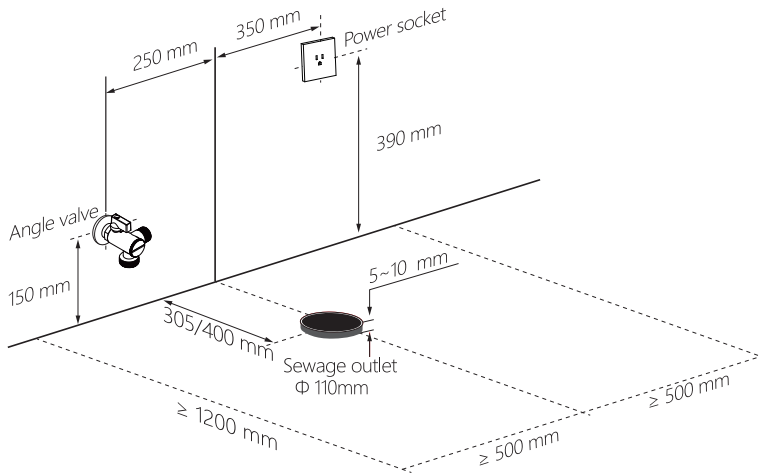

#### ■ Structure for installation

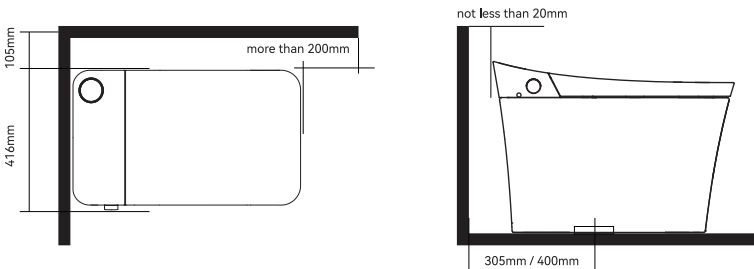

## 9.2 Installation steps

- 1 Open the carton to take out toilet along with accessory box and positioning plate

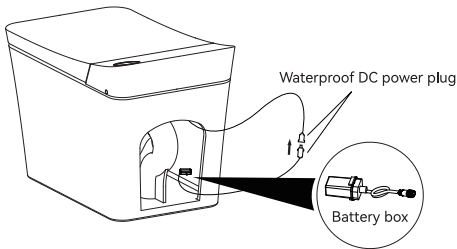
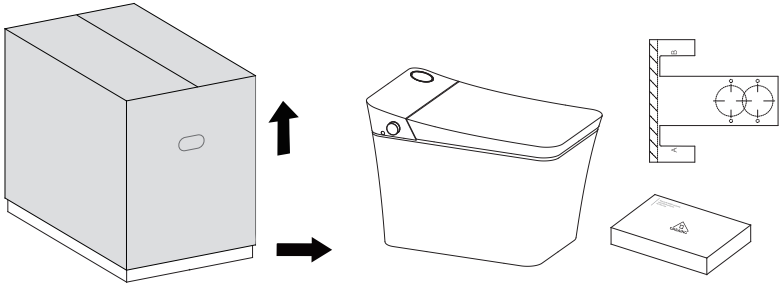

2

### Installation for battery for power-off flush

- Take out the signal line for power-off flush at the back of toilet, and connect it with the line of battery box.
  - Connect the waterproof DC power plug and tighten the waterproof cap.
  - Put the battery box in the proper position as the illustration above.
- ※ Both the battery and connection line have positive and negative poles. Do not insert by force, otherwise the product will be damaged. If any doubt, please inquire your local seller.

**Note:** please refer to page 21 for the backup battery replacement guide.

- 3 Installation for angle valve

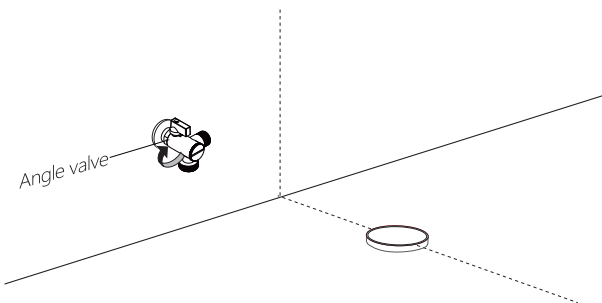

## Installation for angle valve

- Before installation, cut off water.
- Disassemble the old angle valve, and install the special angle valve provided for the machine.
- Install the angle valve and its decorative cover to the proper position, then open the angle valve switch to drain for 1 minute, and drain the dirty water inside the pipe. (Recommend to use a container to catch water when draining)

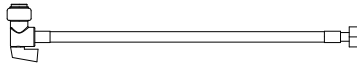

Quick lock valve

Part may be needed if the pipe of the water supply is without thread that doesn't match with the angle valve provided.

- Insert the switch end of the quick lock valve into the pipe and crimp in place.
- Then install the angle valve provided as above.

## 4 Installation for wax ring and ceramic body

### - Optional Installation Method One -

- Align the positioning plate with center line of sewage outlet, and fix it with transparent tape around. According to the the bold line A and B, draw the corresponding outlines, and then remove the positioning plate. As shown in Figure 1.
- Fix the wax ring to the sewage outlet and do the sealing well as Figure 2.
- Lift up the toilet, referring to the sewage outlet, align the ceramic body of the toilet to the outlines drawn on the ground, and slowly place the ceramics onto the ground to make the ceramic coincide with the line marked. Press the ceramics down to make the wax ring fully contacted with drain port of toilet. As shown in Figure 3.

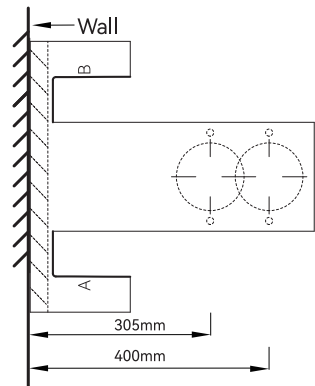

Figure 1

※ After the marks are overlapped, do not move the ceramic body or shake it left or right, otherwise the sealing produced by the wax ring may be damaged, resulting in water leakage.

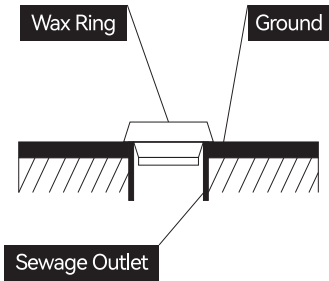

Figure 2

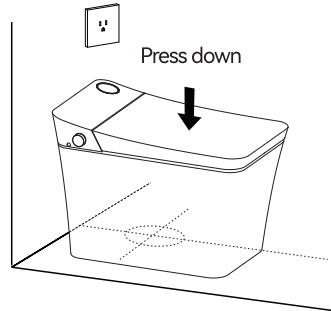

Figure 3

**- Optional Installation Method Two -  
(with bolt and nut)**

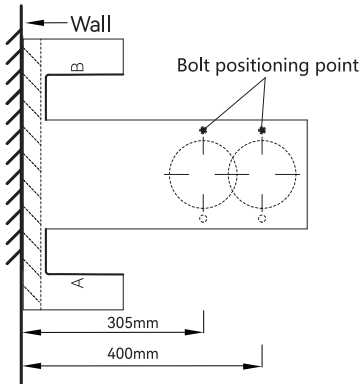

Figure 1

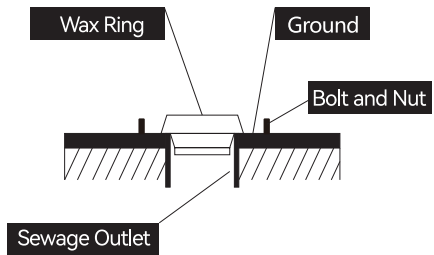

Figure 2

1. Align the positioning plate with center line of sewage outlet, and fix it with transparent tape around. Draw the corresponding outlines according to the the bold lines A and B, then drill holes for bolts according to bolt positioning point, and remove the positionig plate. As shown in Figure 1.
2. Put a flange to the floor with bolts, then fix the wax ring to the sewage outlet, and do the sealing well. As shown in Figure 2.

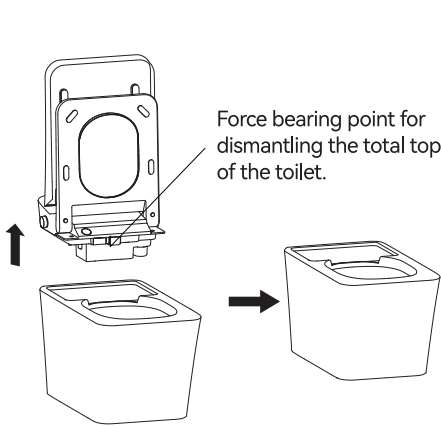

Figure 3

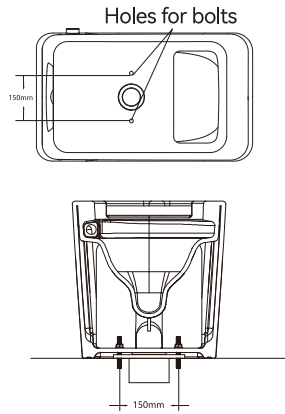
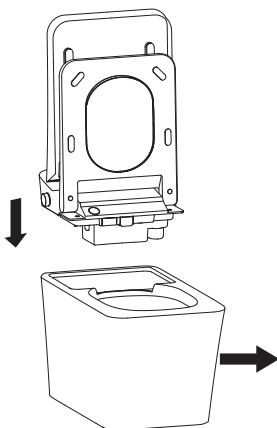

Figure 4

3. Grab the total top from the force bearing point to pull it up with strength to separate it from ceramic body. ( Note: be careful not to apply force on other positions). As shown in Figure 3.
4. Lift up the ceramic body, referring to the sewage outlet, align the ceramic body to the outlines drawn on the ground, and slowly place the ceramic body onto the ground to make it coincide with the lines marked. Press the ceramic body down to make the wax ring fully contacted with its drain port. Finally, tighten the bolts with nuts. As shown in Figure 4.



5. Put the total top back to ceramic body by pressing it down. (Note: there are corresponding buckles for connecting the total top to ceramic body) As shown in Figure 5.

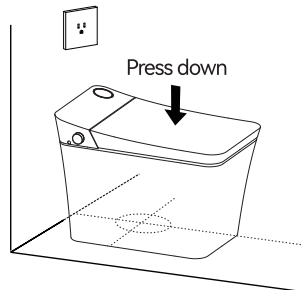
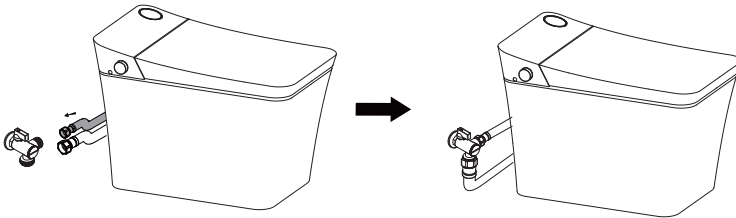

Figure 5

## 5 Connect water hoses



- Connect water hoses to the spout of angle valve (G1/2" and G3/4"), and then tighten them with an adjustable wrench.

## 6 Water connected confirmation

1. Open the angle valve to the maximum as picture.
2. Make sure there is no water leakage at every joint.  
※If water leaks, retighten the nut and install it again.

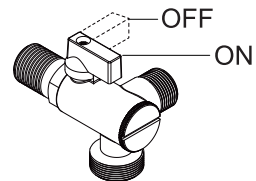

## 7 Power connected confirmation (to test functions)

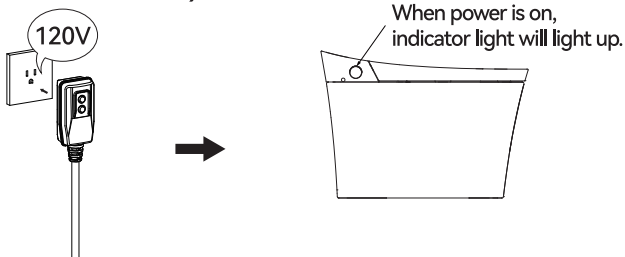

- This product must be ground good, which can only be connected to the dedicated 120V, 60Hz, 16A with ground fault circuit breaker or ground leakage protector circuit.
- Plug in toilet to power socket and make sure the indicator light is on. If it dims, please press the intermediate reset switch.
- When power is on, test whether functions are normal.

## 8 Smear the glass glue

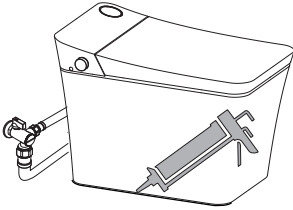

- Smear the glass glue in the gap between the bottom of the ceramics and the ground to prevent water seepage.
- After toilet installation, let it stand for 24 hours to let the glass glue cure to prevent movement.

## 9.3 Remote control installation and replacement for some spare parts.

Please follow below picture for specific steps of installation.

- If the wall is a specific material ( such as wood, dense board, etc. ), please use the appropriate fixing method.
- The place where the remote installed should not easily set by the water.
- Choose a suitable place to install the remote bracket where you can easily touch the remote when you are sitting on the intelligent toilet.
- Confirm that there are no obstacles around the product.

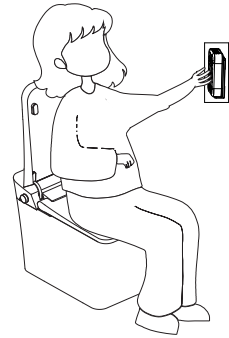

### Installation steps

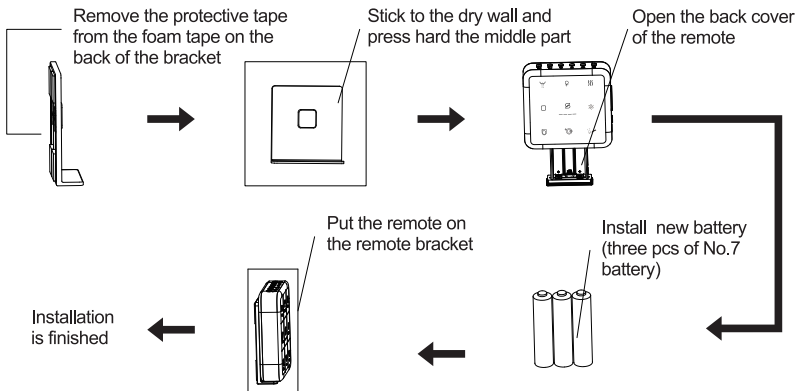

## 9.4 Checklist after installation

After installation finished, you must test run and record the installation results in the table below.

Acceptance inspection item		Conclusion	
Make sure whether it is connected to the AC120V, 16A, 60Hz grounded power supply socket.			
Is the power plug connected stably in the socket ?			
Are the water pipe joints tightened?			
Is the total inlet valve of the water pipe open?			
Is the power indicator light lighted up?			
Can the cleaning nozzle extend and retract? Leakage or not?			
All the function are normal or not : Seating function, butt wash, lady wash (including water pressure adjust, cleaning position adjust), drying (including wind temperature adjust), water temperature adjust, seat temperature adjust, nozzle cleaning, deodorization, remote control and side buttons are used normally or not? The inspection must be completed and confirmed.			
Installation date		Store name	Installer

### ■ Replacement for Battery for power-off flush

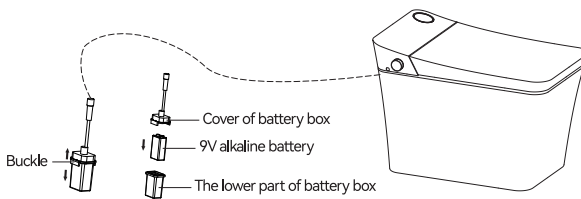

- Open clip of battery box, take out used 9V alkaline battery and recycle it to related organization.
- Put in new 9V alkaline battery as graphic shown above.
- Refer to the battery installation picture to install the battery in the proper location.
- ※ Battery have to be put in a place where children can not get. Please confirm the positive and negative of battery. Do not charge, disassemble, burn the battery. Don't mix it withold batteries or different types of batteries to avoid leakage or explosion.
- ※ The battery box is moisture-proof, please ensure that the buckle is fastened to achieve a good sealing effect.

## 10. Cleaning and maintenance

Please clean and maintain the product regularly to make sure the normal use of product.

### Note

- Please cut off the power, close the angel valve to stop water supplying before maintenance.
- Do not rinse this product with water during maintenance.

### Maintenance of the steel mesh filter

- For your health, Please clean the steel mesh ( or replace the filter ) according to the local water quality.
- When the cleaning strength becomes weaker, please clean the steel mesh ( or replace the filter ) in time. Please close the water supply angle valve when disassembling the filter. When installing the filter, tighten it to avoid water leakage.
- Turn the filter counter clockwise with a coin to open the filter.

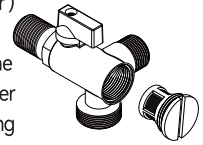

toothbrush



It is recommended to clean the steel mesh every 1-2 months.

### Common problem

Fault	Failure analysis	Solution
No water	Check if there's water supply or not	Open the water source
	Check if the water supply angle valve is open or not	Open the water supply angle valve
	Check if the water supply angle valve filter net is blocked or not	Clean the filter net
Water leakage at the joint	Check if the joint is tighten or not	Tighten the joint
	Check if the inside seals of joint is aged or damaged	Replace the seals
	Check if the water supply angle valve is fully open or not	Fully open the water supply angle valve
Water flow becomes smaller	Check if the water supply angle valve filter net is blocked or not	Clean the filter net
	After cleaning the water supply angle valve net, the water flow is still small	Replace the filter
Device leakage	Check if the seals is damaged or not	Replace the seals
	The water supply angle valve is not matching with device.	Replace the suitable parts

## Plastic parts and ceramics's cleaning and maintenance

- When the product become dusty or dirty, wipe the product with a soft damp cloth.
- The ceramics can be cleaned with neutral detergent combined with cold or warm water, using a softbrush, rag or sponge.
- ※ Do not use unsuitable detergent (such as concentrated sulfuric acid, concentrated nitric acid, glacial acetic acid, carbon tetraoxide, chloroform, acetone, methyl ethylketone, benzene, toluene, phenol, cresol, dimethylformamide, methyl ether, large Soybean oil, acetate, 40% nitric acid, concentrated hydrochloric acid, 95% alcohol, gasoline, kerosene, brake oil, etc.)

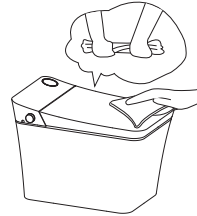

## Nozzle's cleaning and maintenance

In the condition of nobody on the seatpress [ butt wash ] button or rotate the [ butt wash ] button on the toilet for 2 seconds, the washer will extend automatically. If the nozzle is dirty, hold the washer and clean it with a toothbrush.

- ※ Do not use excessive force, the nozzle will be damaged.

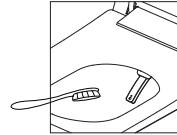

### WARNING

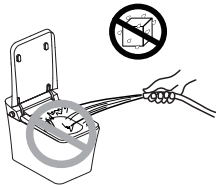

Please don't fill the water & detergent into the intelligent toilet or remote. Please don't make the intelligent toilet or plug wet by water or detergent. Or else may make electric shock or fire hazard.

## Antifreeze in winter ( when the ambient temperature is below 33.8°F )

1. When you go out for a business trip or traveling and not use the toilet for a long time. first close the water supply angle valve, then press the flush button in the remote to conduct a drainage, after 30 seconds of drainage, please be sure to pullout the power plug.
2. The remaining water may freeze when the product is transported over long distances or stored for a long time in cold winter. To prevent freezing, please take antifreeze measures.

### Note

- Connect to power and water after putting the product for 30 minutes until it is naturally thawed in warm room.
- If it is frozen and failed to spray water, you can cover the water supply pipe or connection part with cloth which has been soaked in hot water to make it thawed. ( Please do not pour the water supply pipe with hot water or blow it with hot wind.)

## 11. Product specification

Item	Content
Rated voltage	120V~, 16A, 60Hz
Rated power	1150W
Power cable	1.5m
Applicable water pressure	0.14-0.75MPa
Water temperature	39.2 °F~95 °F
Ambient temperature	39.2 °F~104 °F
Net weight	99.2 LBS
Waterproof level	IPX4
Cleaning water flow	0.5~0.7L/min
Seat temperature adjust	(Normal temperature-around104°F) total 4 levels
Water temperature adjust	(Normal temperature-around104°F)total 4 levels
Wind temperature adjust	(Normal temperature-around104 °F~149 °F)total 4 levels
Cleaning time	Normal cleaning is about 90s, SPA cleaning is about 5mins
Nozzle position adjust	4 levels
Heating mode	Fraquency conversion heat
Safety device	Leakage Protection switch, wind / seat / water temperature Protection
Deodorization	Nano intelligent deodorization

### Note

Rated power: when the ambient temperature is 73.4°F; inlet water static pressure is 0.2 MPa±0.02 MPa, inlet water temperature is 59°F ± 33.8°F, and seat temperature ( high ), water temperature ( high ), water pressure ( high ), the maxium stable power we can read in the mode of lady wash.

## 12. Troubleshooting Guide

If something goes wrong, please read the following to try to solve the problem. If can't solve, please contact to seller.

### Power switch

Fault	Failure analysis	Solutions
Product not work	Check whether the socket is electrified or not ? the plug is loosened or not ?	Check circuit
	Check whether the toilet is power on or not ? ( The sidebutton light is on or not )	Long press the stop/power button 【 ■ 】 on side panel, and it will light up.
	Check whether the leakage protection button in the plug is on or off ( The light of leakage protection plug is on or off )	Pull out the plug and connect it later. Press the reset switch of the leakage protection plug. If still not work, pull out the plug and ask a professional repair man for help.

### Butt wash, Lady wash

No water from the nozzle	Check whether there's water supply or not	Wait for water supply back to normal
	Check whether the angle valve is closed or not	Open the angle valve
	Check whether filter is blocked up or not	Clean the filter mesh inside
	Check whether the water inlet pipe is bended or not	Ensure that the inlet pipe is not bended
Cleaning strength not enough	Check whether the water pressure is in low gear or not	Turn up water by remote
	Check whether filter is blocked up or not	Clean the filter mesh inside
Nozzle water abnormal	Abnormal operation	Unplug the power cord and plug it in 1 mins later
Water temperature not enough	Check whether the water temperature is in low gear or not	Reference manuahow to adjust water temperature
Washer aways dripping water	Solenoid valve failure	Please find a professional repair man
Washer can not use	Seat body induction failure.	Please find a professional repair man

## Drying / Wind temperature

Fault	Failure analysis	Solutions
Drying with cold wind	Check whether the wind temperature setting is closed or in low gear	Adjust the wind temperature according to manual

## Seat temperature

Fault	Failure analysis	Solutions
No seat heating/lower temperature	Check whether the seat temperature setting is closed or in low gear	Adjust the seat temperature according to manual

## Remote

Fault	Failure analysis	Solutions
Remote failure	Low power of battery	Replace the old battery
	Check whether there's any water inside remote or not	Dry the water with dry cotton cloth

## Ceramics

Fault	Failure analysis	Solutions
Flush undrained when in lower water pressure	Angle valve blocked	Clean the angle valve according to the manual
	Water pressure is too low	Measuring the water volume which is less than 10L for 30s or not ( Our suggestion is to buy a booster pump )
	Water inlet pipe bended	Ensure the water supplyline is smooth
Normal water pressure but flush undrained and no siphon	outlet has air leakage	Please ask professional repair man for help.
	S pipe blocked	Using a toilet dredge
Normal water pressure but flushing not work	Check the angle valve is closed or not	Open the angle valve again
	Flush valve failure	Please ask professional repair man for help

## Others

Fault	Failure analysis	Solutions
Cover/seat falls down too fast	Failure of damping slowing down function	Clean the filter according to the manual
Not automatically flush after men urinate	Check if you only open the cover with out opening the seat	Open both the cover and seat
Orderly cyclic work of each function	Mistaken into engineering debugging mode	Pull out the plug and connect the plug after 1 minute
Night light not work	Check the night light whether is close or not	Open the night light according to the manual
Leakage		Close the angle valve and disconnect the power supply then contact your installer





Model: BR30001AACH1W

Phone: 888-257-3857

Website: [www.casainc.com](http://www.casainc.com)

Customer Service: [service@casainc.com](mailto:service@casainc.com)