

Assembly Instructions

Caution: You must read these Assembly Instructions before you proceed.

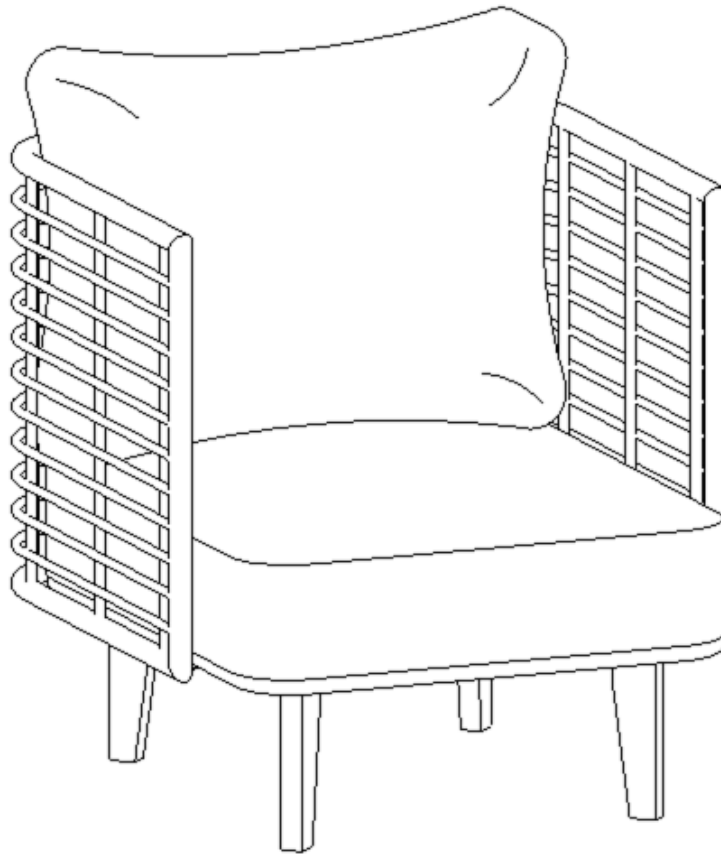



Please look into the Seat Panel for hardware packs and legs.

CHAIR



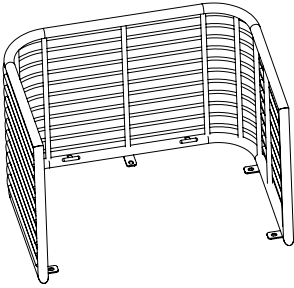

Caution: This Chair is NOT a TOY.
Keep your child/children at bay during the assembly process.
Whenever moving/lifting the Chair and to prevent damage to the Chair, two adults are required to execute these actions.

Part List

Label	Picture	Description	Qty
A		Backrest Panel	1
B		Seat Panel	1
C		Leg	4
D		Back Cushion	1
E		Seat Cushion	1

Hardware

No.	Picture	Description	Qty
①		Bolt (M6 x 20mm)	22
②		Washer (M6/6.5 x 1mm)	22
③		Allen Wrench	2

Assembly Preparation

Before Beginning Assembly:

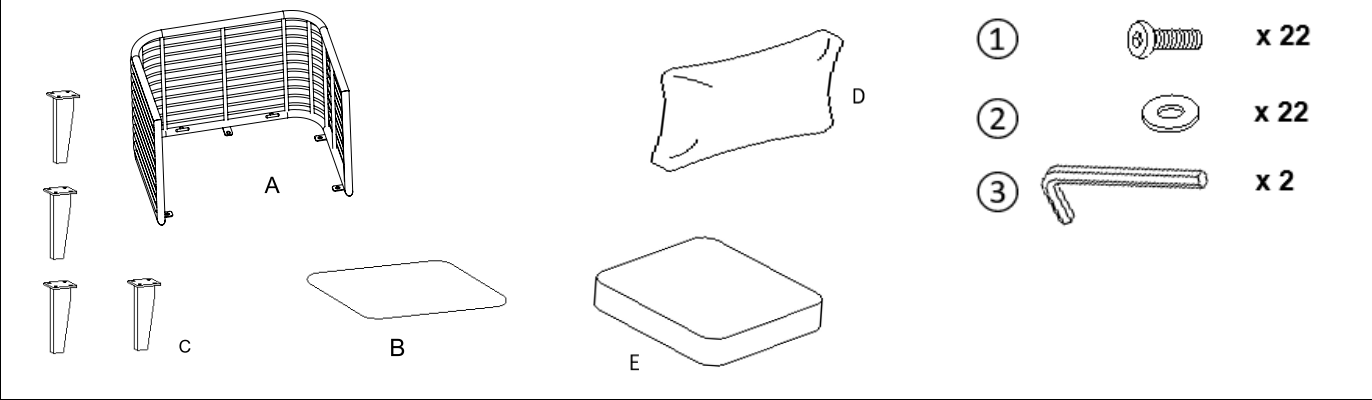

- Read instructions, cover to cover.
- Have 2 adults on hand for assembly.
- Do not assemble on flooring or carpet.
- Assemble on a clean non-marring surface (packing foam).
- Save all packaging until finished.

Assembly Steps

Overview

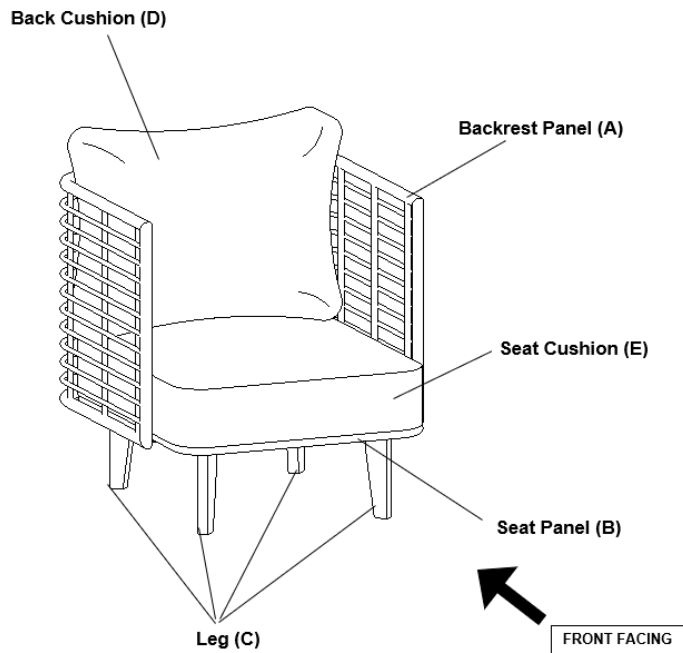

This Chair has multiple parts and may require up to some 20 minutes to assemble. To give you an overview of the Chair parts, the above picture is to help you put the various parts into perspective. Please read through the instructions below to familiarise yourself with the parts and steps before assembly.

Step 1

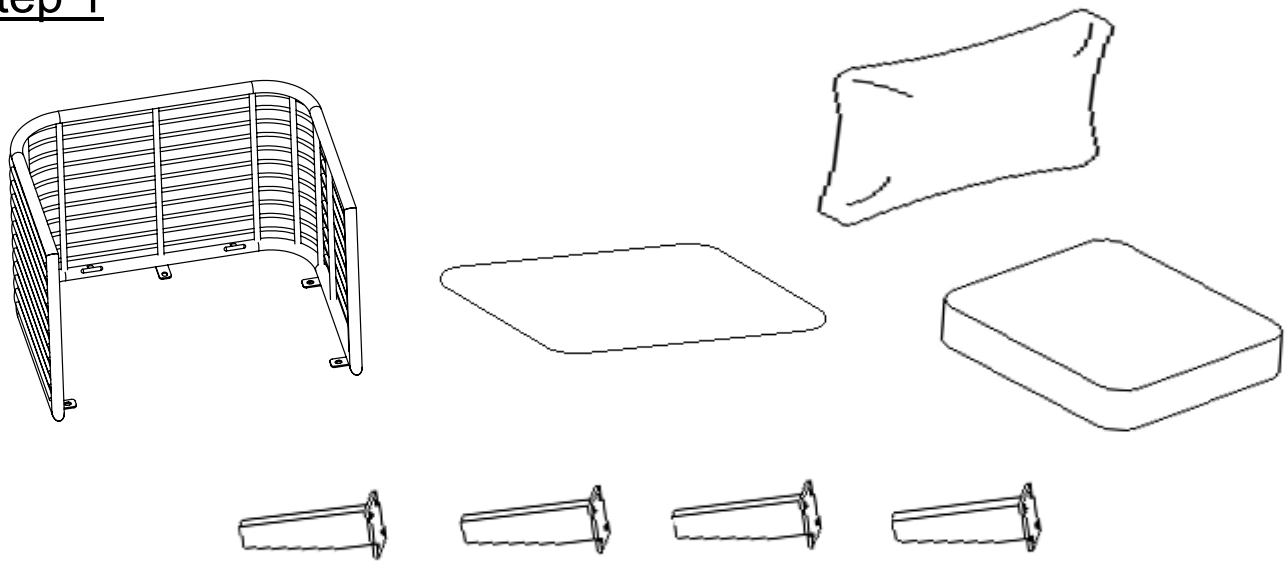

Unpack and place all parts on a clean, non-marring surface.

Step 2

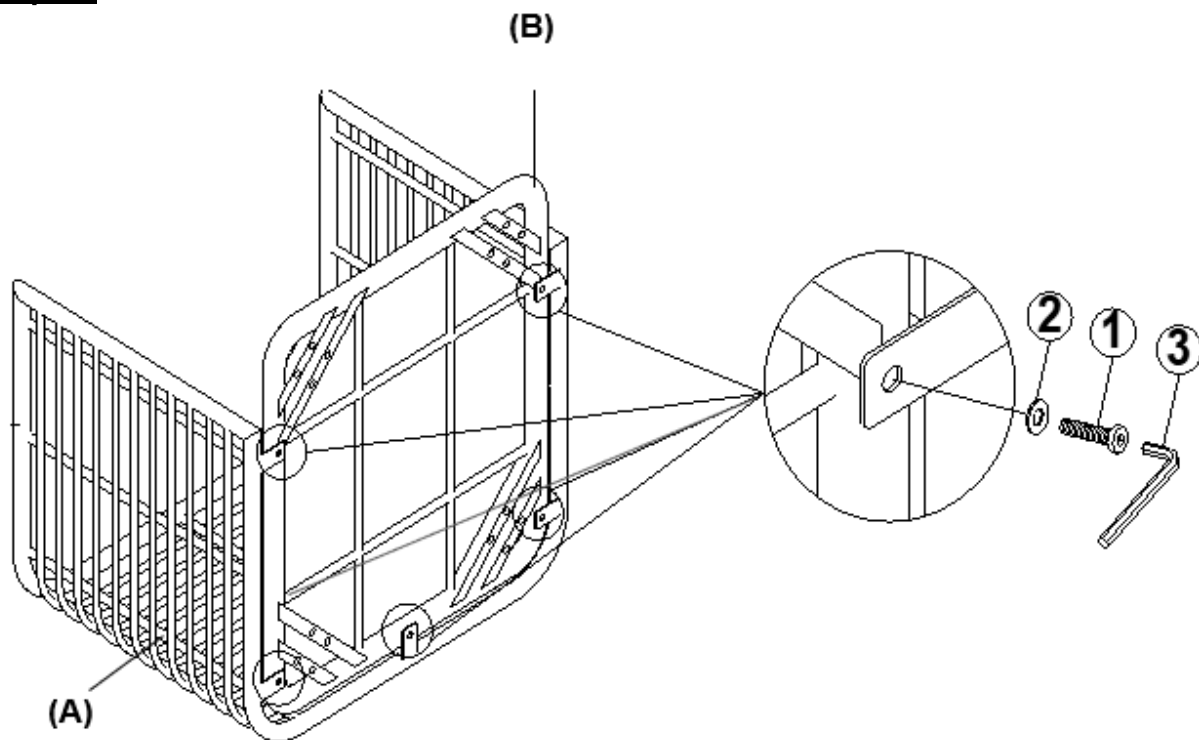

Place the Backrest Panel (A) face up onto a clean, non-marring surface.

With the assistance from your adult partner, attach the Seat Panel (B) to the Backrest Panel (A) by using the Bolts (①), Washers (②) and the Allen Wrench (③) as shown in the picture above.

DO NOT fully tighten the Bolts.

Step 3

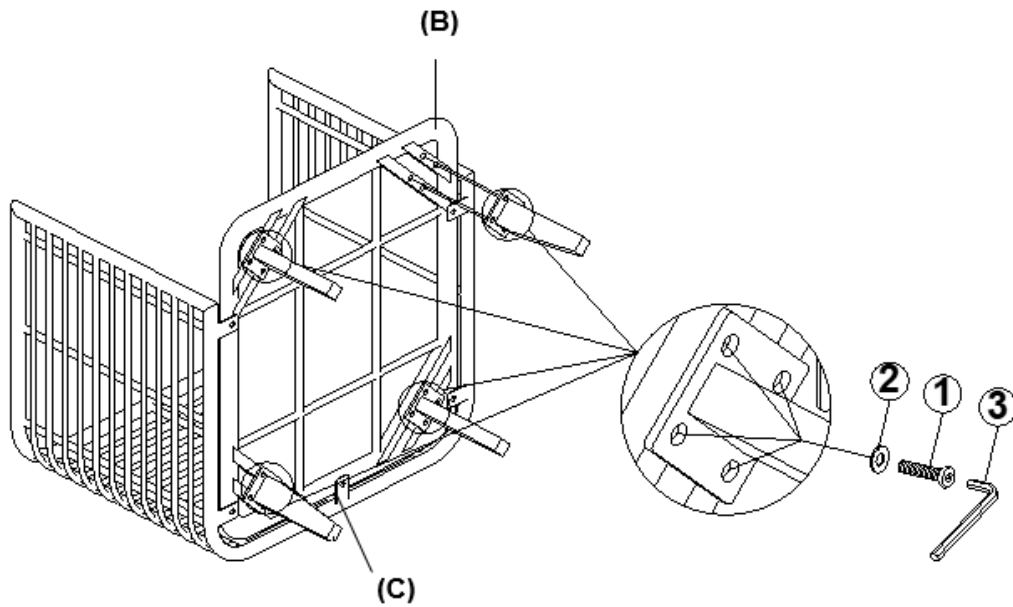

With the help from your adult partner, attach all the Legs (C) to the Seat Panel (B) of the assembled part in step 2 by using the Bolts (①), Washers (②) and the Allen Wrench (③) as shown in the picture above.

DO NOT fully tighten the Bolts.

Step 4

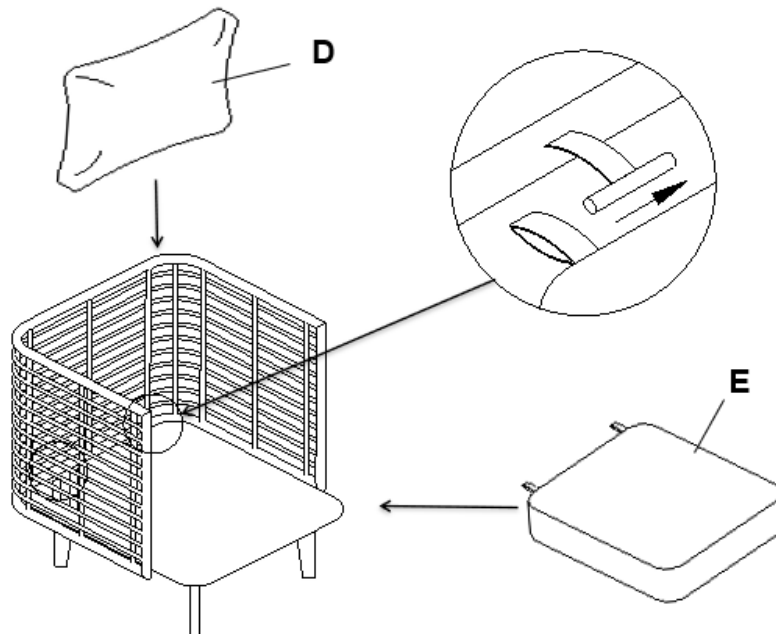

Stand the assembled part in Step 3 up, then put the Seat Cushion (E) and the Back Cushion (D) on the Chair.

Attach the mattress holder on the seat and on the mattress together as shown in the picture above.

Step 5

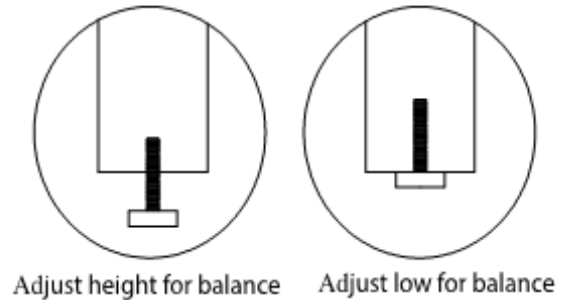
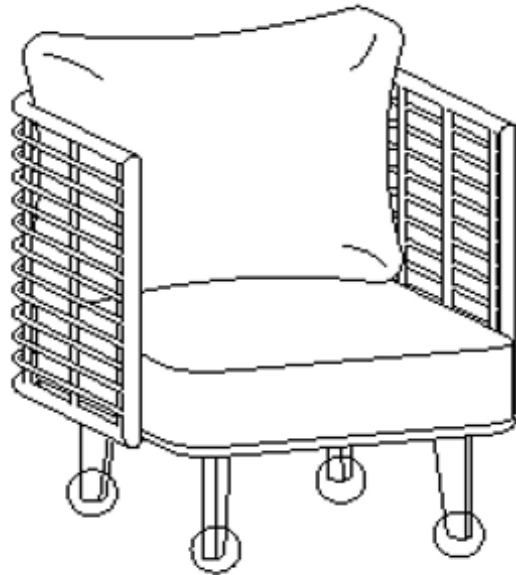

Adjust Pre-installed Levellers
height for balance

Place the Chair on a **LEVEL SURFACE**.

Inspect it and make sure all parts are adequately connected.

Gently and gracefully, sit into to the Chair.

This will help to align all the parts at all joint areas.

Then get off the Chair and proceed to tighten the Bolts in a sequential manner.

When tightening the Bolts tighten sequentially.

DO NOT tighten any Bolts fully and then move on towards the next one.

If there are still wobbles, loosen the Bolts and execute this same process.











Adjust the Levellers until the Chair is level with the ground.

To adjust the Levellers, get assistance from an adult partner to lift/lean and hold the Chair while you are working.

Your Chair is ready for use.

This Chair can only be used on flat, level surface.

Care & Maintenance

- ⊘  • Prolonged exposure to rain may cause rusting which can stain floors.
- ⊘  • Do not put hot items directly on furniture surface.
- ⊘  • Do not clean furniture with harsh cleansers or polish.
- ✓  • To obtain the longest lifespan of your outdoor products, minimizing exposure to direct sunlight is recommended.
- ⊘  • Children should not climb or jump on the furniture.
- ⊘  • Do not write on furniture without a padded barrier to protect the surface.
- ✓  • To obtain the longest lifespan of your outdoor products, avoid extended and lengthy exposure to rain, snow, and direct sunshine. Whenever possible cover the product and /or place under patio or awnings.
- ⊘  • Not for commercial use. For residential use only.
- ⊘  • Stains may be removed with mild soap solution and damp cloth..
- ✓  • **Keep away from sources of ignition.**
- ✓  • Dust and pick-up spills using a clean, non-colored, lint-free cloth.