

Pure & Easy



ASSEMBLY INSTRUCTIONS



NOTICE

IMPORTANT, RETAIN FOR FUTURE REFERENCE: READ CAREFULLY
WICHTIG, FÜR SPÄTERE NACHSCHLAGE AUFBEWAHREN: SORGFÄLTIG LESEN
IMPORTANTE, GUARDAR PARA REFERENCIA FUTURA: LEER ATENTAMENTE
IMPORTANTE, CONSERVARE PER RIFERIMENTI FUTURI: LEGGERE ATTENTAMENTE
IMPORTANT, À CONSERVER POUR RÉFÉRENCE FUTURE : LIRE ATTENTIVEMENT

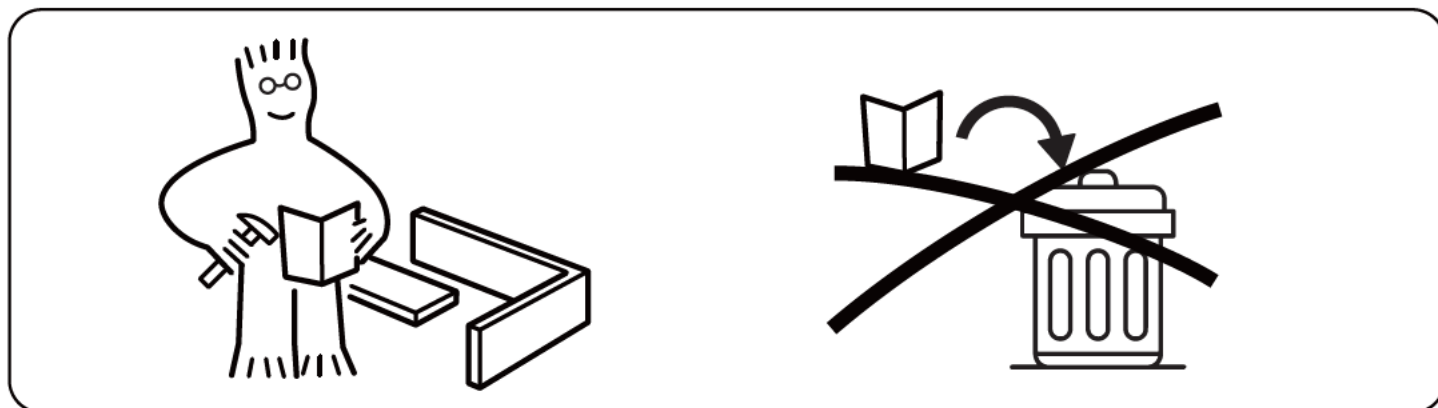

Assemble on a flat, clean and soft surface.
Auf einer flachen, sauberen und weichen Oberfläche zusammenbauen.
Assembler sur une surface plate, propre et douce.
Assemblare su una superficie piatta, pulita e morbida.
Ensamblar sobre una superficie plana, limpia y suave.

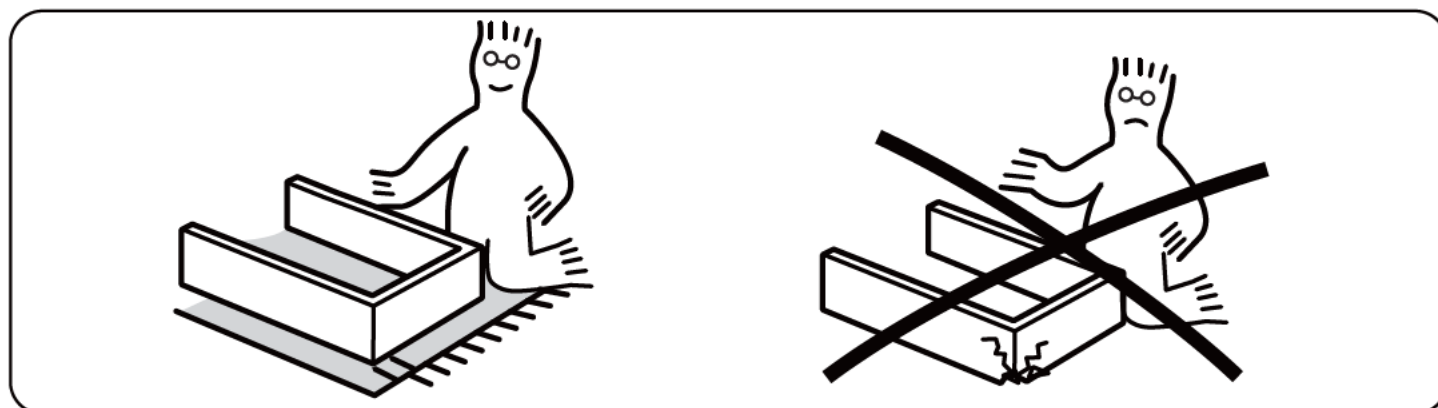

Professional installation is highly recommended.
Eine professionelle Installation wird dringend empfohlen.
Une installation professionnelle est fortement recommandée.
Si raccomanda vivamente l'installazione professionale.
Se recomienda altamente la instalación profesional.



Periodically Check That All Components Are Tightly Secured.
Überprüfen Sie Regelmäßig, Dass Alle Komponenten Fest Gesichert Sind.
Vérifiez Périodiquement Que Tous Les Composants Sont Bien Fixés.
Controllare Periodicamente Che Tutti I Componenti Siano Ben Fissati.
Verifique Periódicamente Que Todos Los Componentes Estén Bien Asegurados.



It is recommended that multiple people assemble this product.
Es wird empfohlen, dass mehrere Personen dieses Produkt zusammenbauen.
Il est recommandé que plusieurs personnes assemblent ce produit.
Si raccomanda che più persone assemblino questo prodotto.
Se recomienda que varias personas ensamblen este producto.

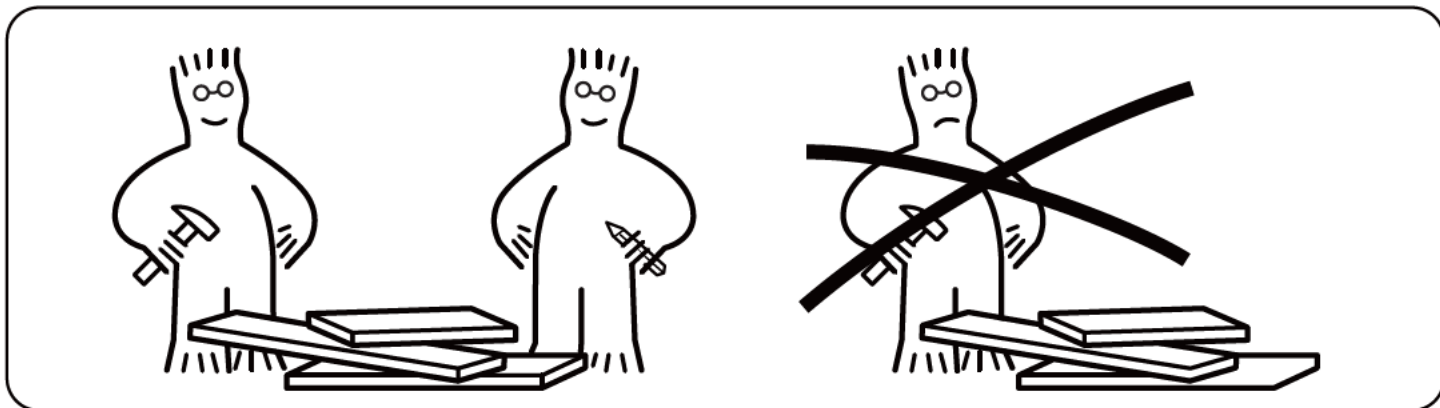

Please have the following auxiliary tools ready:

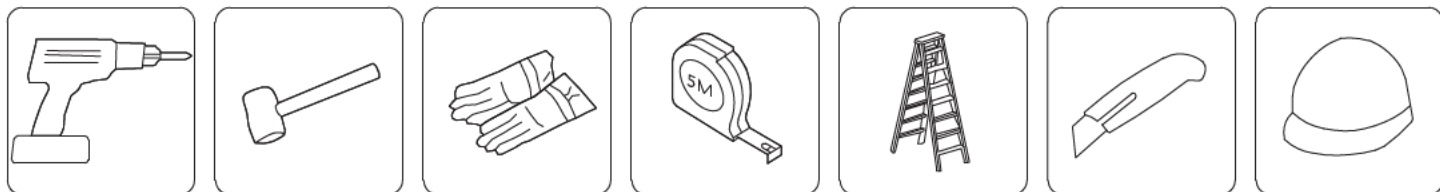

USING CAM LOCK AND QUICKFIT
 VERWENDUNG VON NOCKENSCHLOSS UND QUICKFIT
 UTILISATION DE SERRURE À CAME ET QUICKFIT
 USO DI SERRATURA A LEVA E QUICKFIT
 USANDO EL CIERRE DE LEVA Y QUICKFIT

Tighten QuickFit until the shoulder is flush with the panel. Do not overtighten or undertighten.
 Ziehen Sie den Quickfit an, bis die Schulter bündig mit der Platte ist. Nicht zu fest oder zu locker anziehen.

Serrez le quickfit jusqu'à ce que l'épaulement soit affleurant avec le panneau. Ne serrez pas trop ou trop peu.

Stringere il quickfit fino a quando la spalla è a filo con il pannello. Non stringere troppo o troppo poco.
 Apriete el quickfit hasta que el hombro esté al ras con el panel. No apriete demasiado ni demasiado poco.

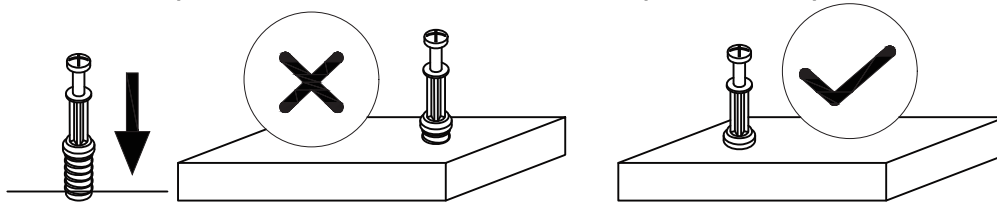

When fitting the cam lock, ensure the starting position is correct before inserting the connecting QuickFit.

Stellen Sie beim Einbau des nockenschloss sicher, dass die Startposition korrekt ist, bevor Sie den verbindenden Quickfit einsetzen.

Lors de la pose du serrure à came, assurez-vous que la position de départ est correcte avant d'insérer le quickfit de connexion.

Quando si monta il serratura a leva, assicurarsi che la posizione di partenza sia corretta prima di inserire il quickfit di collegamento.

Al instalar el cierre de leva, asegúrese de que la posición inicial sea correcta antes de insertar el quickfit de conexión.

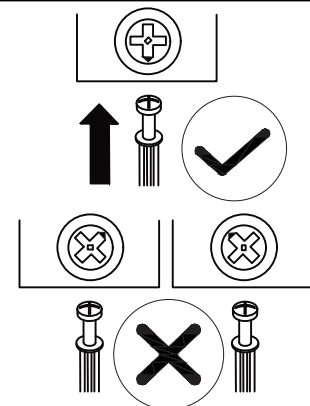

The QuickFit head should be in the center of the cam lock when the two panels are joined. The cam lock should be inserted before the QuickFit. Turn the cam lock clockwise to tighten.

Der Quickfit-Kopf sollte sich in der Mitte des nockenschloss befinden, wenn die beiden Platten verbunden sind. Der nockenschloss sollte vor dem Quickfit eingesetzt werden. Drehen Sie den nockenschloss im Uhrzeigersinn, um ihn zu befestigen.

La tête du quickfit doit être au centre du serrure à came lorsque les deux panneaux sont assemblés. Le serrure à came doit être inséré avant le quickfit. Tournez le serrure à came dans le sens des aiguilles d'une montre pour le serrer.







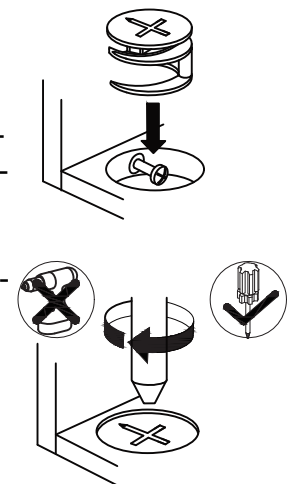

La testa del quickfit dovrebbe essere al centro del serratura a leva quando i due pannelli sono uniti. Il serratura a leva deve essere inserito prima del quickfit.





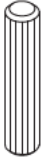
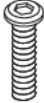

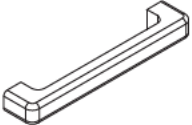
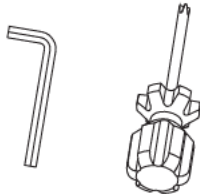

Ruotare il serratura a leva in senso orario per stringere.

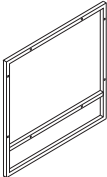
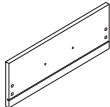
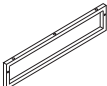
La cabeza del quickfit debe estar en el centro del cam lock cuando los dos paneles estén unidos. El cierre de leva debe insertarse antes del quickfit. Gire el cierre de leva en sentido horario para apretar.

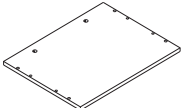

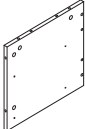
PARTS

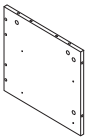
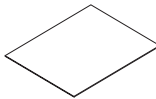
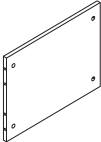
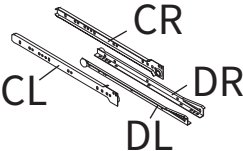
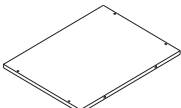
Item no. Nr. N° d'article Articolo No. Artículo No.	Reference Image Referenzbild Image de référence Immagine di riferimento Imagen de referencia	Qty. Menge Qté. Qtà Cant.	Item no. Nr. N° d'article Articolo No. Artículo No.	Reference Image Referenzbild Image de référence Immagine di riferimento Imagen de referencia	Qty. Menge Qté. Qtà Cant.
(A)	 M6 X 35MM	X24	(G)	 M4 X 18MM	X4
(B)	 φ15 X 9MM	X24	(H)	 M3X 12MM	X16
(C)	 φ8 X 40MM	X8	(I)	 M6 X 25MM	X3
(D)	 M5 X 40MM	X12	(J)	 M6 X 12MM	X4
(E)	 M6 X H10MM	X4	(K)	 φ20	X8
(F)	 8347-128	X2	(-)		X1

Item no. Nr. N° d'article Articolo No. Artículo No.	Reference Image Referenzbild Image de référence Immagine di riferimento Imagen de referencia	Qty. Menge Qté. Qtà Cant.	Item no. Nr. N° d'article Articolo No. Artículo No.	Reference Image Referenzbild Image de référence Immagine di riferimento Imagen de referencia	Qty. Menge Qté. Qtà Cant.
1		X1	8		X2
2		X1	9		X2
3		X1	10		X2
4		X1	11		X2
5		X1	12		X2
6		X1	13		X2
7		X1	14		X2

EXPLODED VIEW

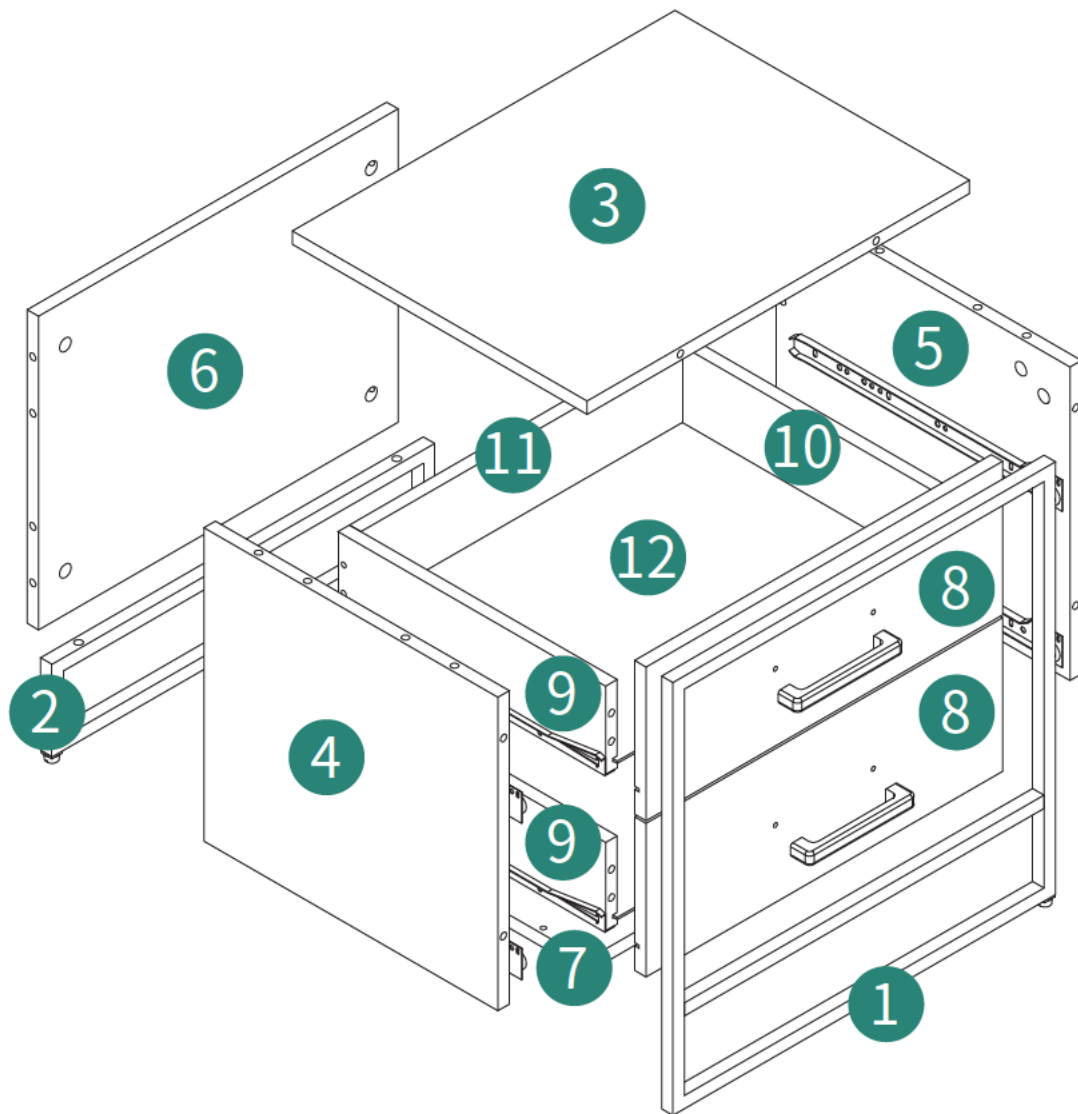

ASSEMBLY

1

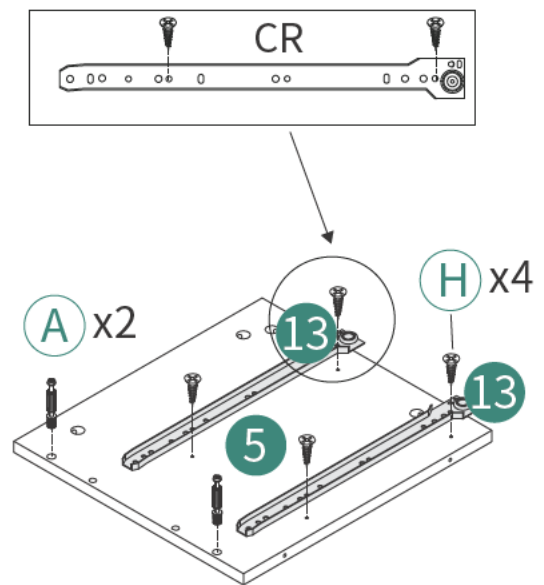
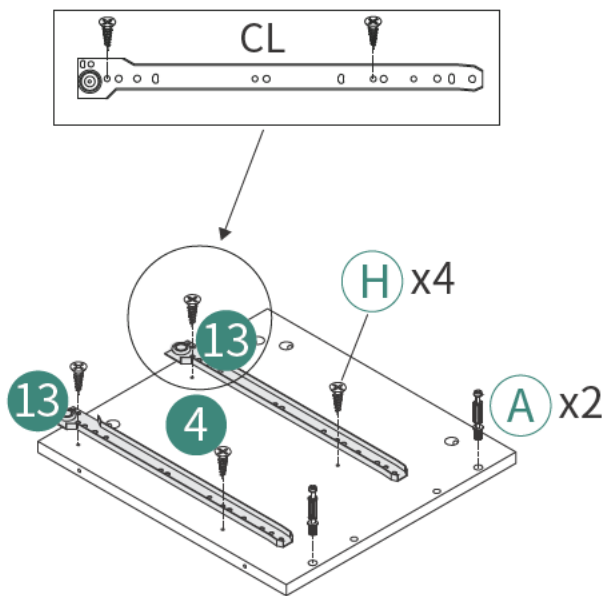
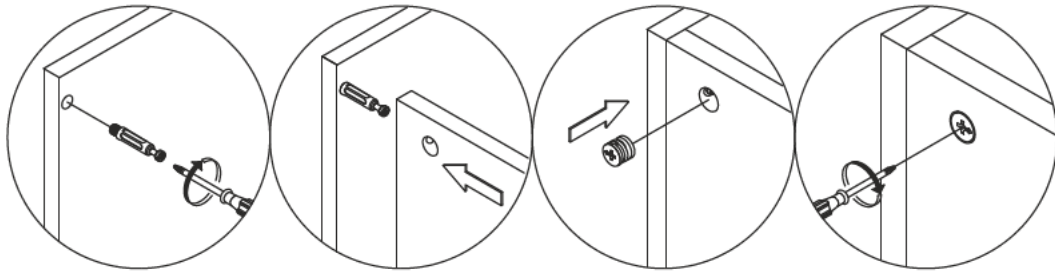
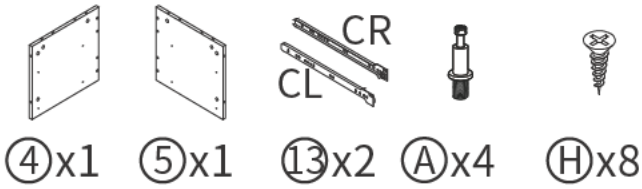

2

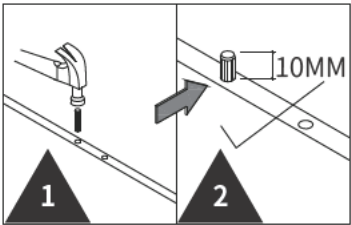
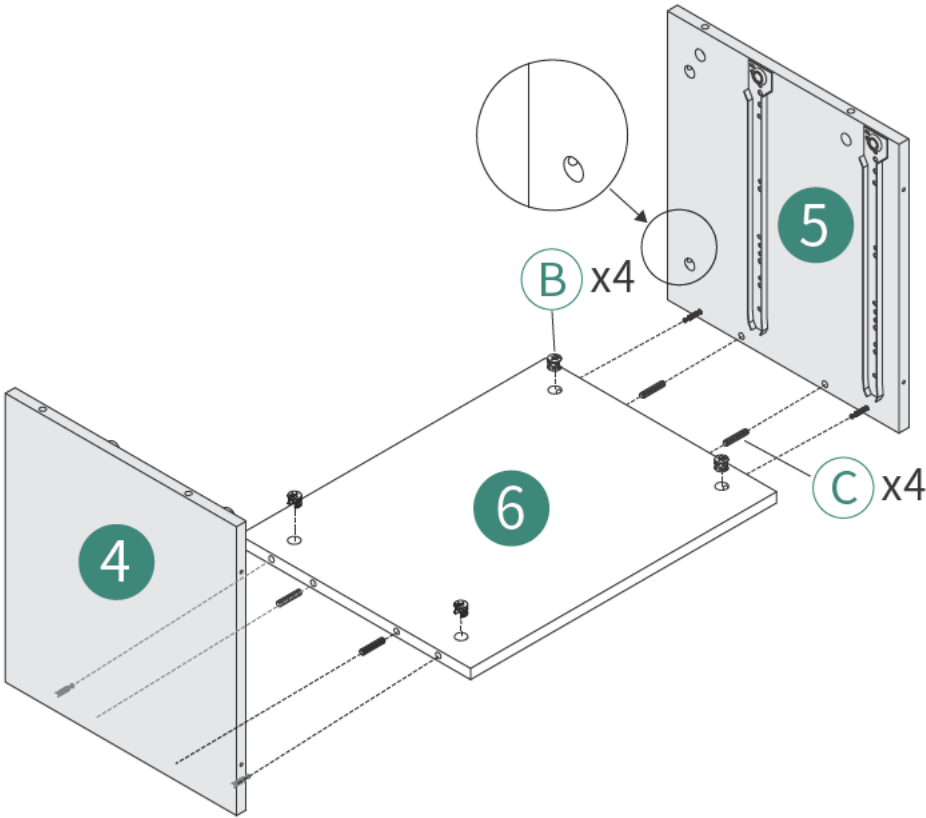
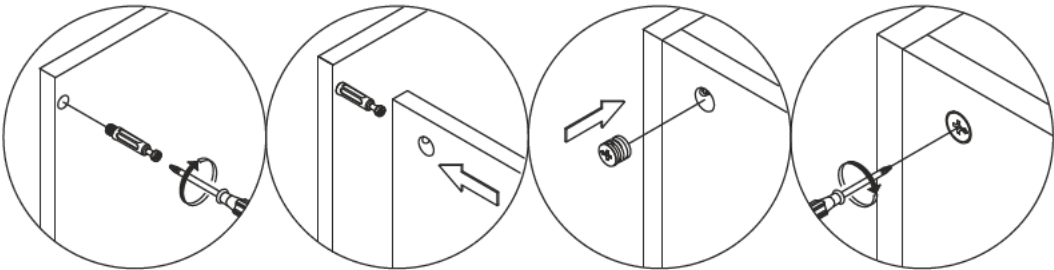
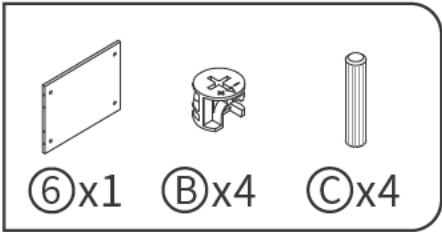

3

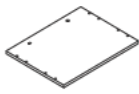

⑥x1



Ⓐx4



Ⓑx4



Ⓒx4

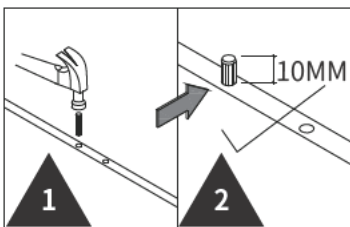
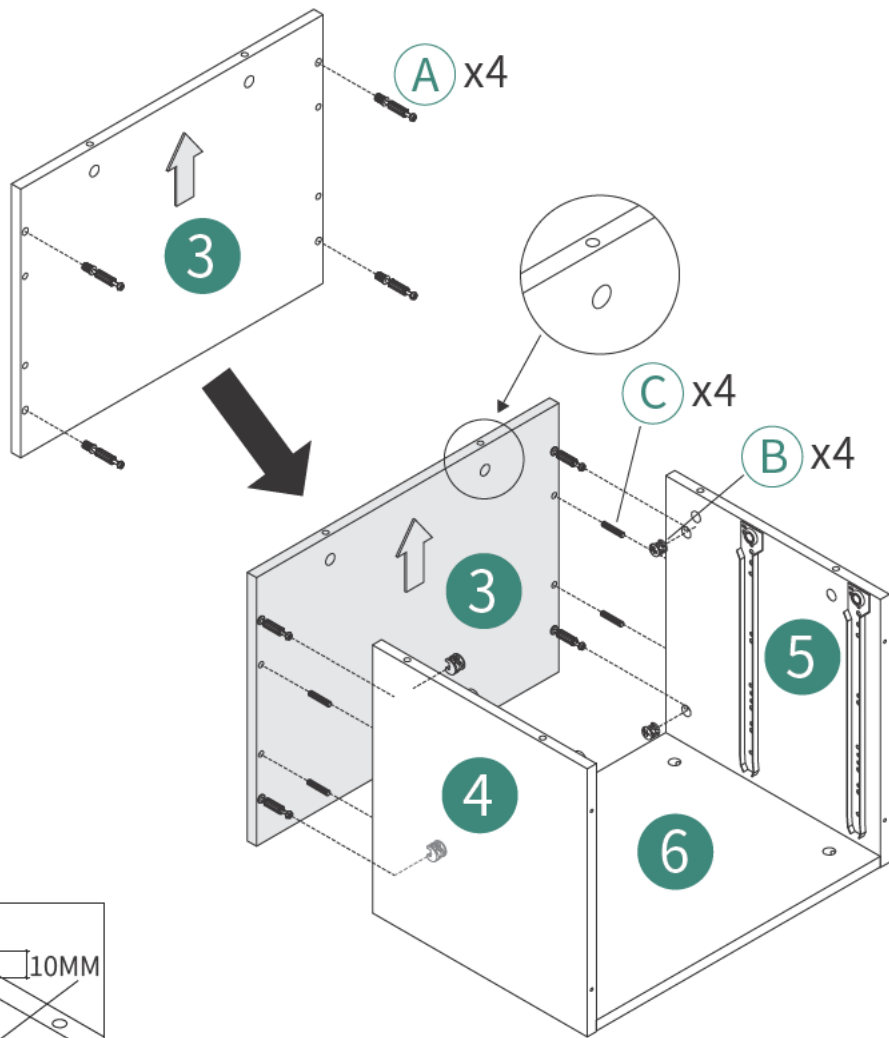
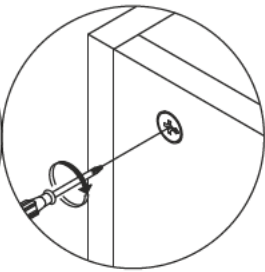
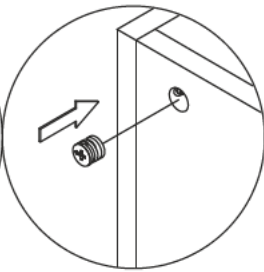
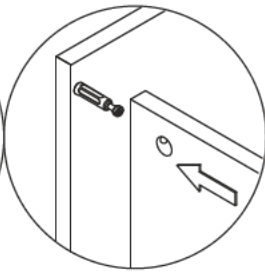
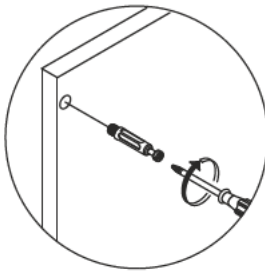

4

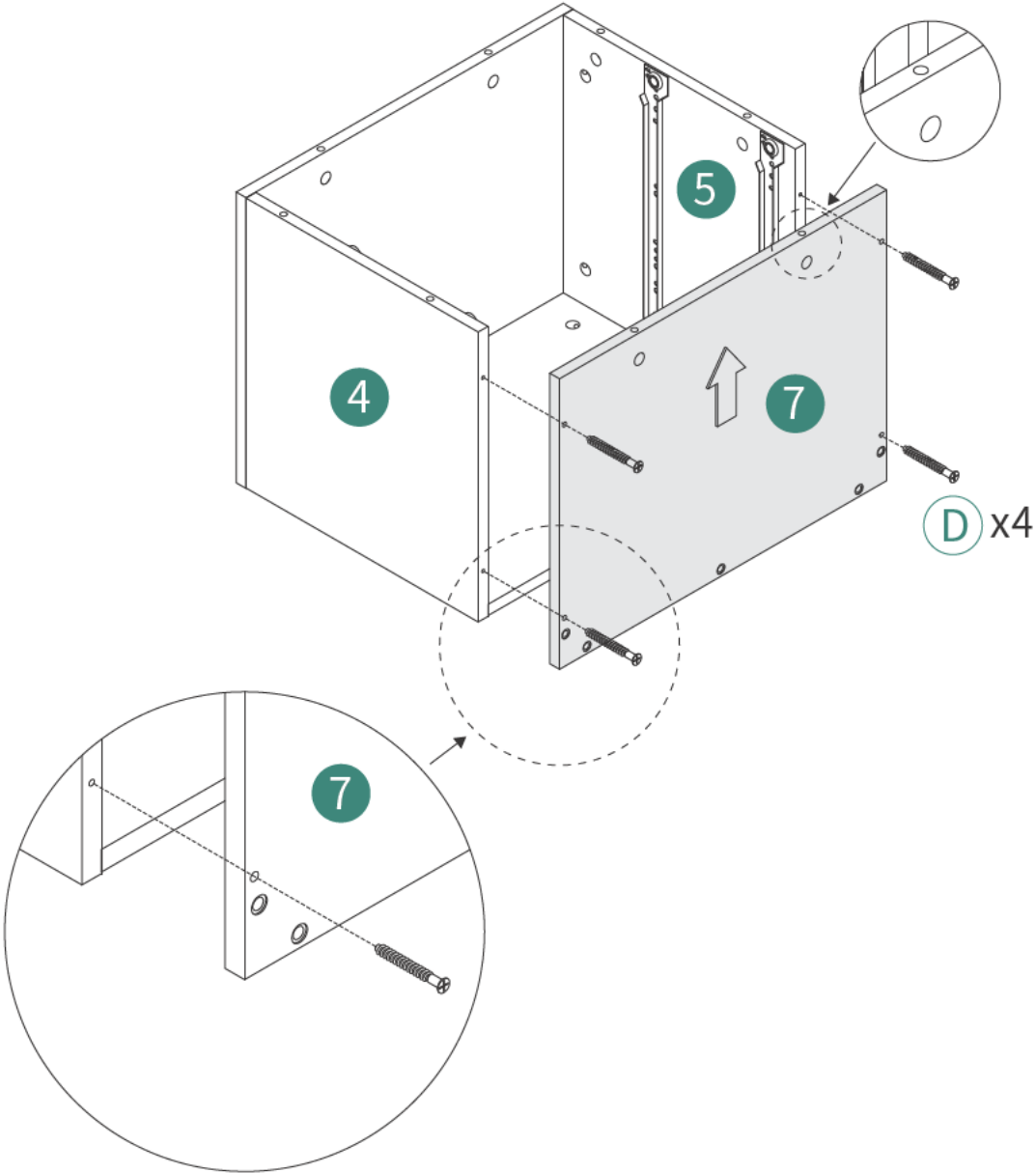
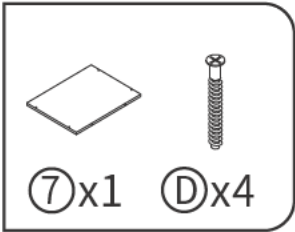

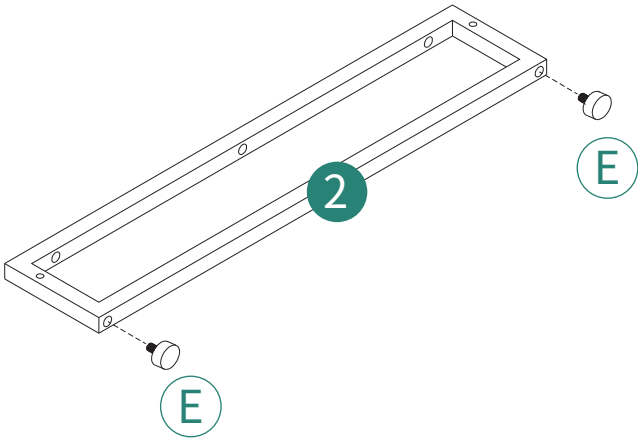
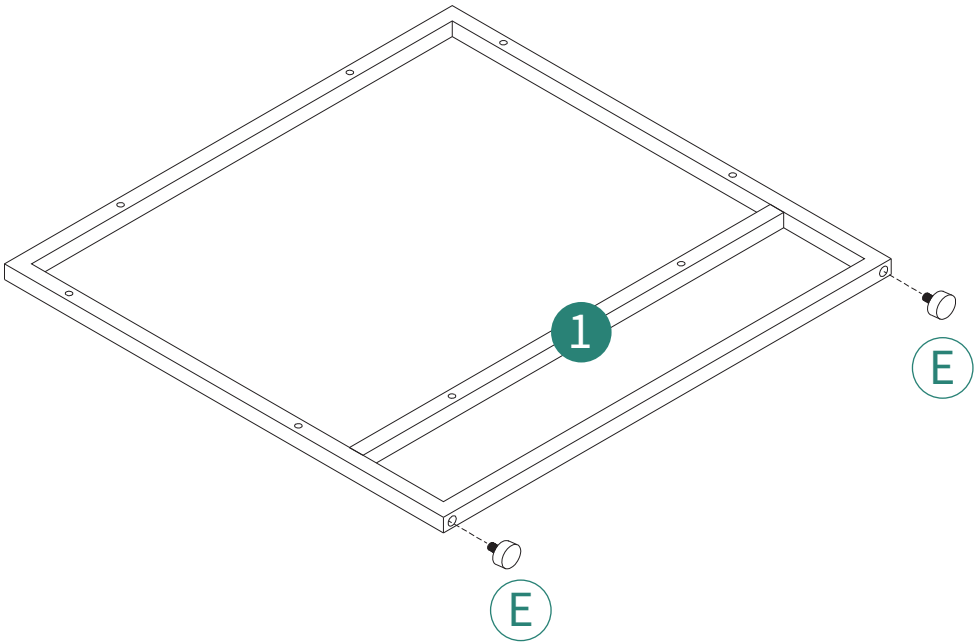

5

①x1 ②x1 ③E x4



6



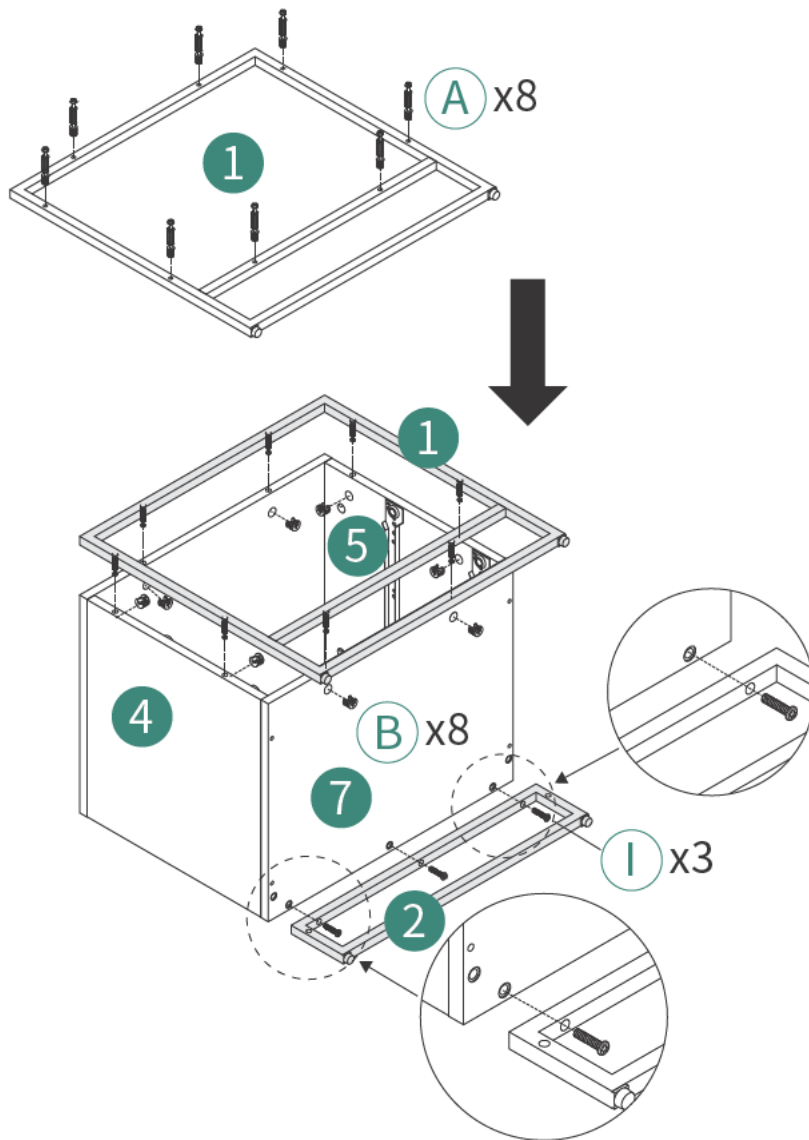
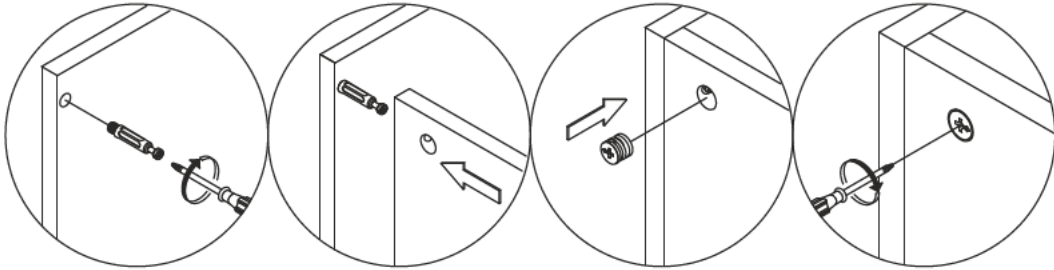

  
A x8 B x8 I x3

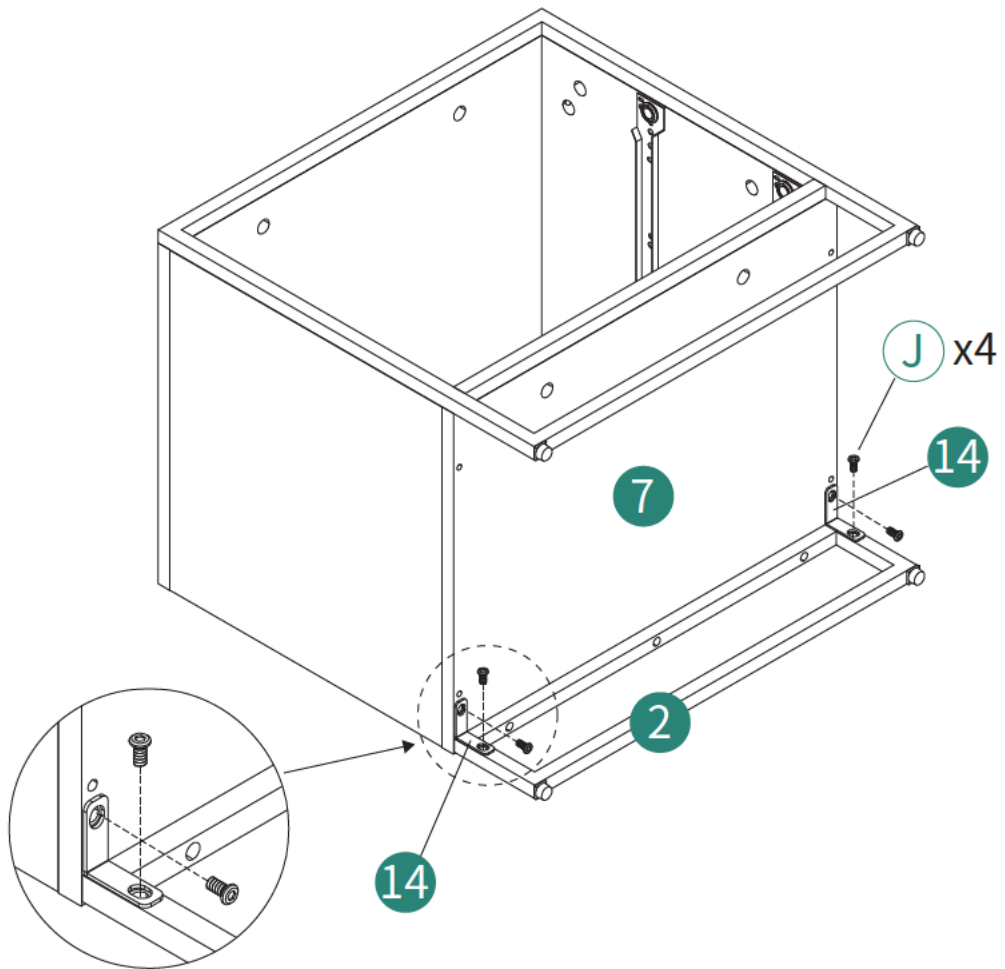
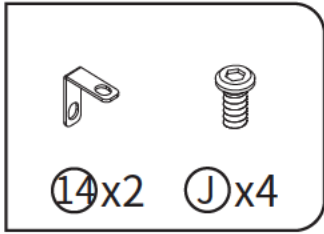

7



8

-  ⑨x2
-  ⑩x2
-  ⑪x2
-  ⑫x2
-  ①x8

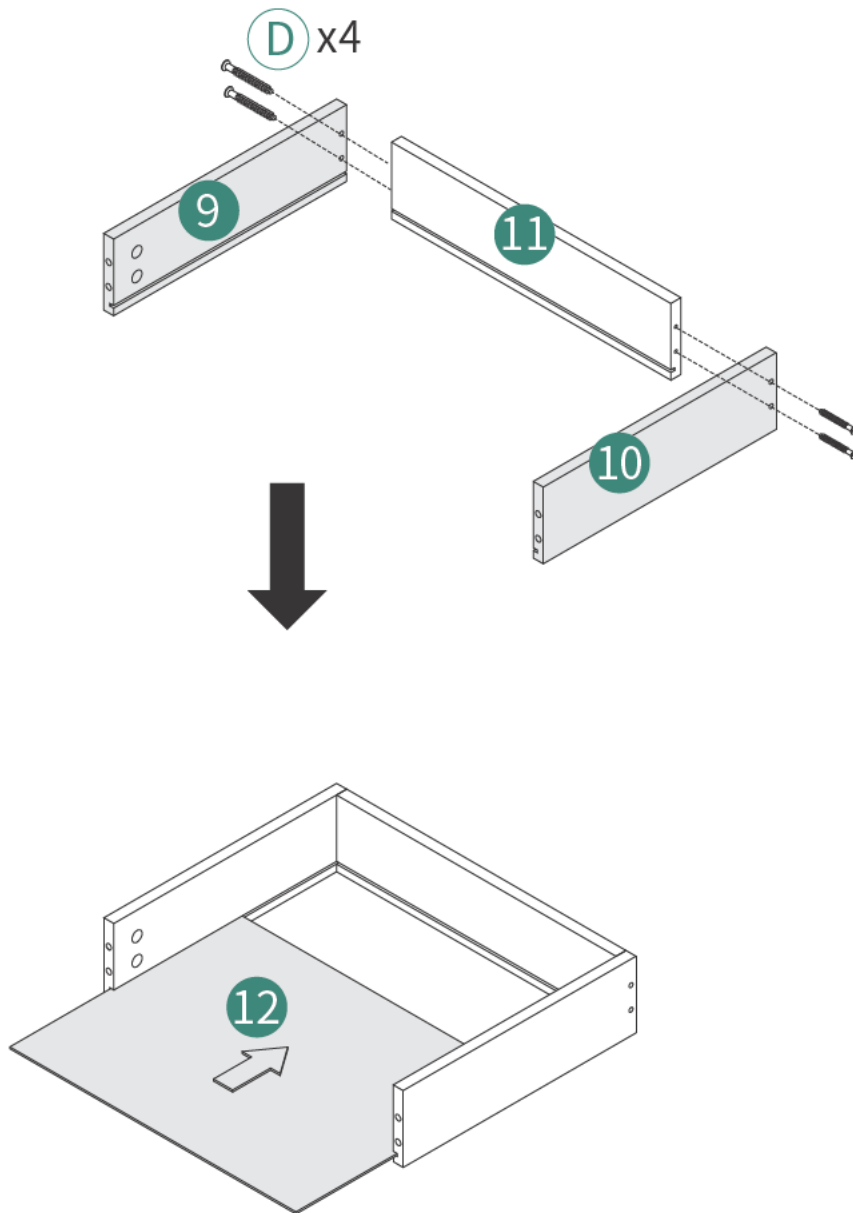

x 2

9

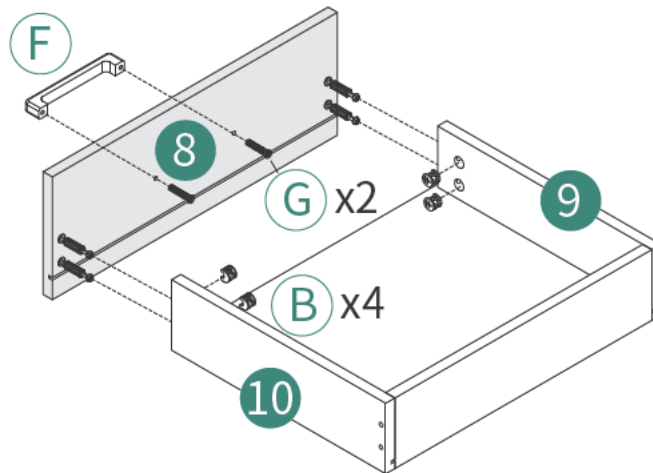
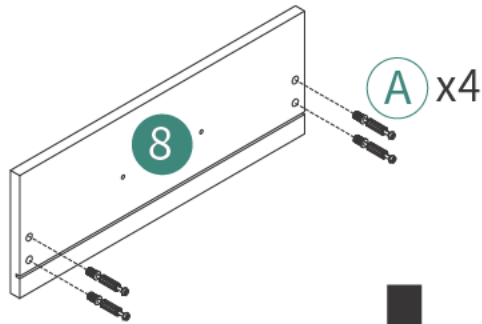
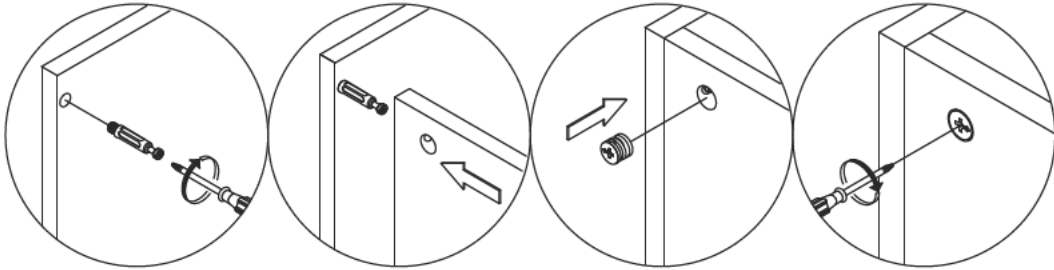

x 2

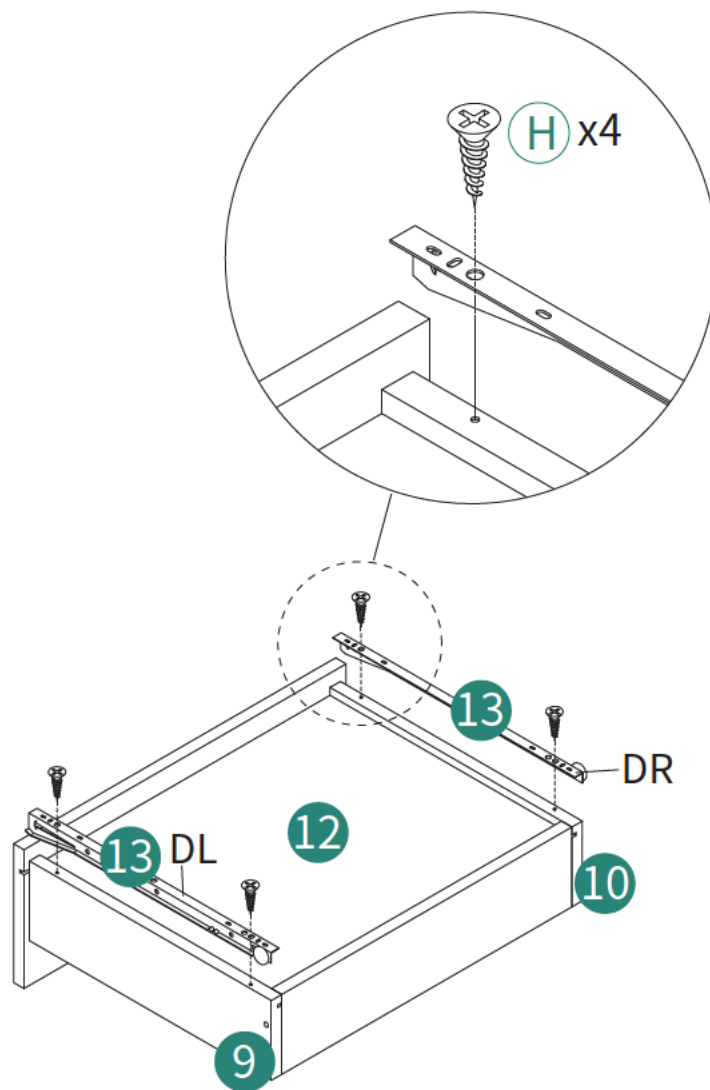
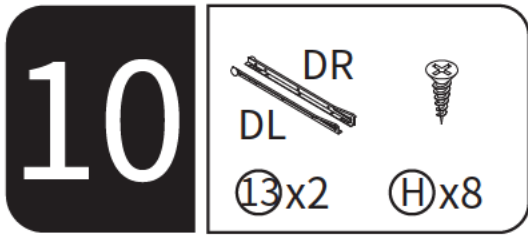

x 2

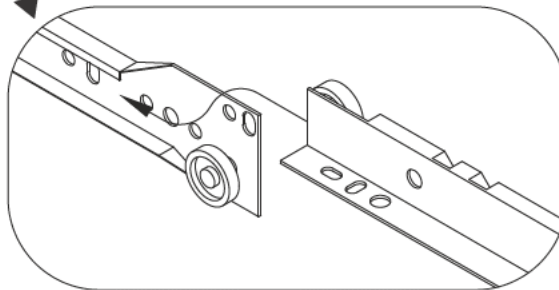
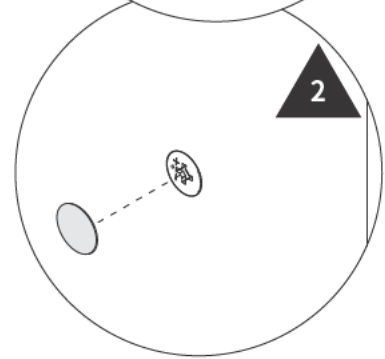
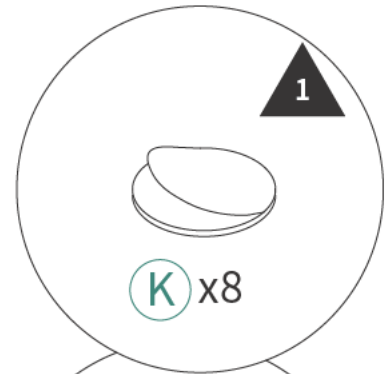
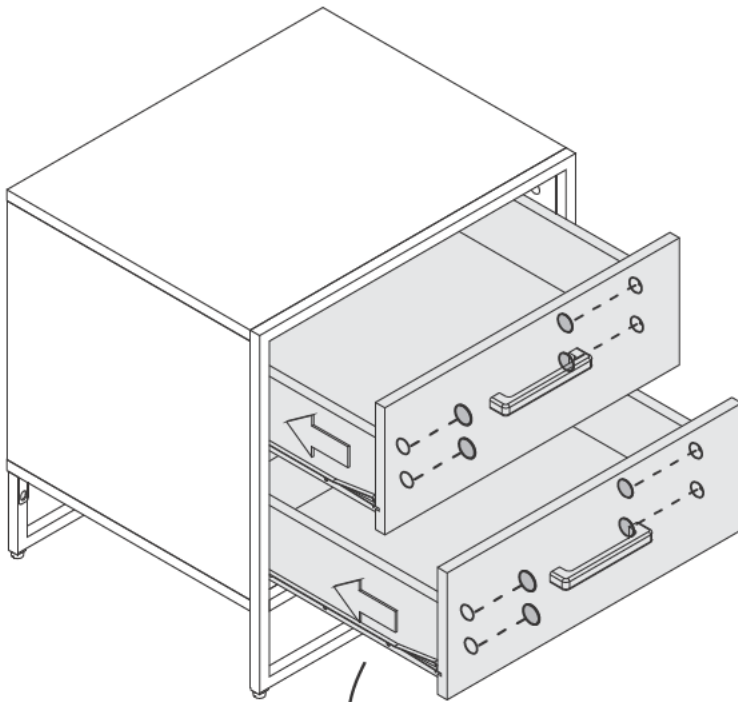

- Installation Completed
- Installation Abgeschlossen
- Installation Complétée
- Installazione Completata
- Instalación Completada

HELP CENTER



Inquiry



Assembly issue



Missing parts

If you encounter any difficulties during assembly, please contact us.

Wenn Sie während der Montage auf Schwierigkeiten stoßen, kontaktieren Sie uns bitte.

Si vous rencontrez des difficultés lors du montage, veuillez nous contacter.

Se incontri difficoltà durante il montaggio, ti preghiamo di contattarci.

Si encuentras alguna dificultad durante el ensamblaje, por favor contáctanos.

DISCLAIMER

Manufacturer and seller expressly disclaim any and all liability for personal injury, property damage or loss, whether direct, indirect, or incidental, resulting from the incorrect attachment, improper use, inadequate maintenance, unapproved modification, or neglect of this product.

Der Hersteller und Verkäufer lehnen ausdrücklich jegliche Haftung für Personenschäden, Sachschäden oder Verluste ab, egal ob direkt, indirekt oder zufällig, die durch falsche Anbringung, unsachgemäßen Gebrauch, unzureichende Wartung, nicht genehmigte Änderungen oder Vernachlässigung dieses Produkts entstehen.

El fabricante y vendedor renuncian expresamente a toda responsabilidad por lesiones personales, daños materiales o pérdidas, ya sean directos, indirectos o incidentales, derivados de la incorrecta colocación, uso inadecuado, mantenimiento insuficiente, modificación no aprobada o negligencia de este producto.

Il produttore e il venditore declinano espressamente ogni responsabilità per lesioni personali, danni materiali o perdite, dirette, indirette o incidentali, derivanti dall'errato fissaggio, uso improprio, manutenzione inadeguata, modifica non autorizzata o negligenza di questo prodotto.

Le fabricant et le vendeur déclinent expressément toute responsabilité en cas de blessures corporelles, de dommages matériels ou de pertes, qu'ils soient directs, indirects ou accessoires, résultant de la fixation incorrecte, de l'utilisation inappropriée, de l'entretien insuffisant, de la modification non approuvée ou de la négligence de ce produit.