

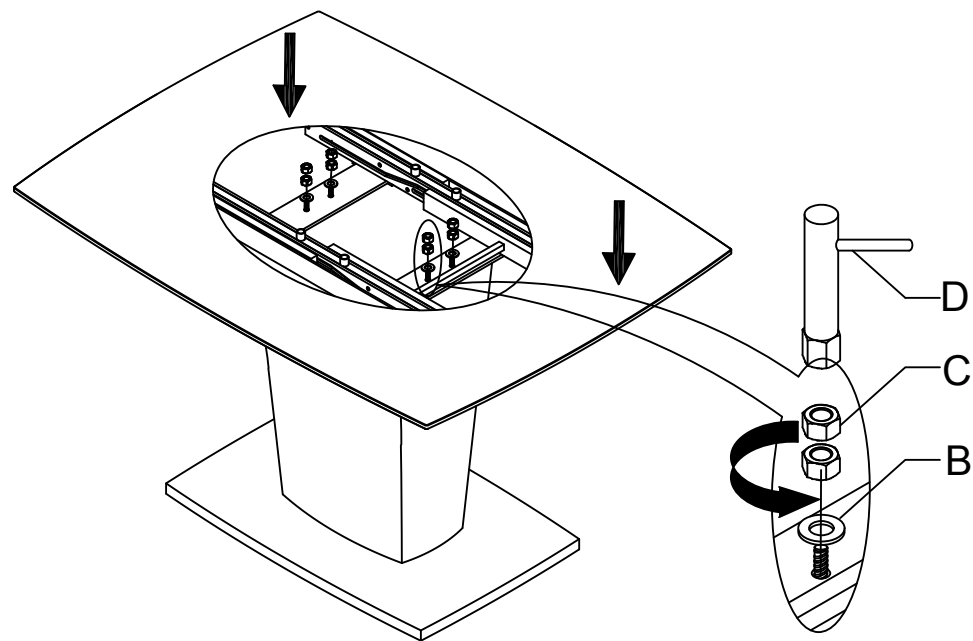





2



		A	B	C	D
		 M10×650		 M10	
×2	×2	×4	×4	×8	×1