

20'

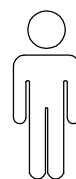

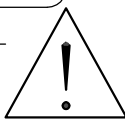

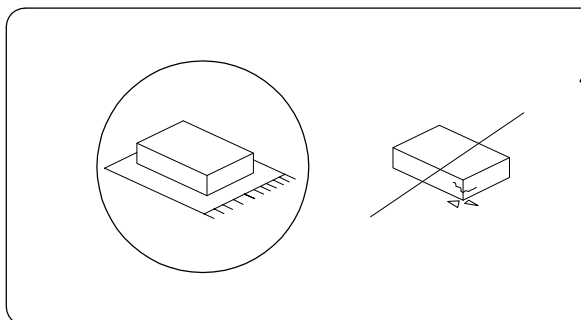
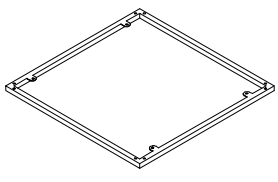
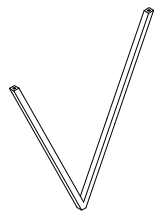
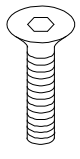
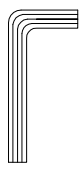

1

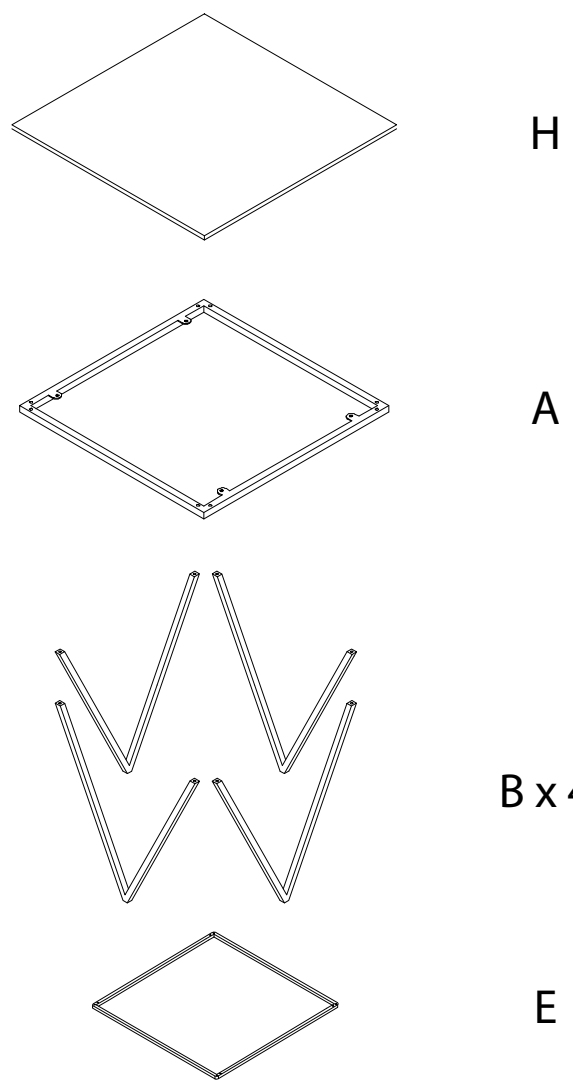
1/4

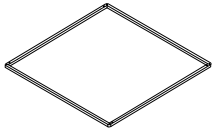
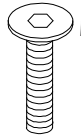
<p><b>A</b></p>  <p><b>x 1</b></p>	<p><b>B</b></p>  <p><b>x 4</b></p>	<p><b>C</b></p>  <p>M6 x 25</p> <p><b>x 8</b></p>	<p><b>D</b></p>  <p><b>x 1</b></p>
---	---	--	---

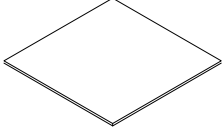

<p><b>E</b></p>  <p><b>x 1</b></p>	<p><b>F</b></p>  <p>M6 x 25</p> <p><b>x 4</b></p>	<p><b>G</b></p>  <p><b>x 4</b></p>	<p><b>H</b></p>  <p><b>x 1</b></p>	<p><b>I</b></p>  <p>M3.5 x 16</p> <p><b>x 4</b></p>
---	--	---	--	--

1

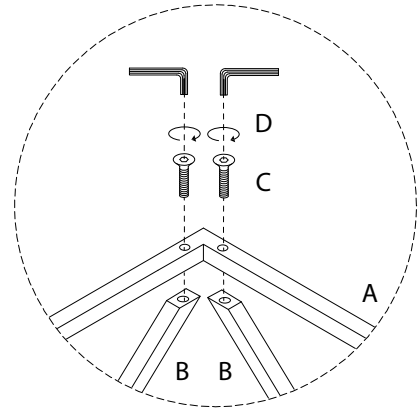
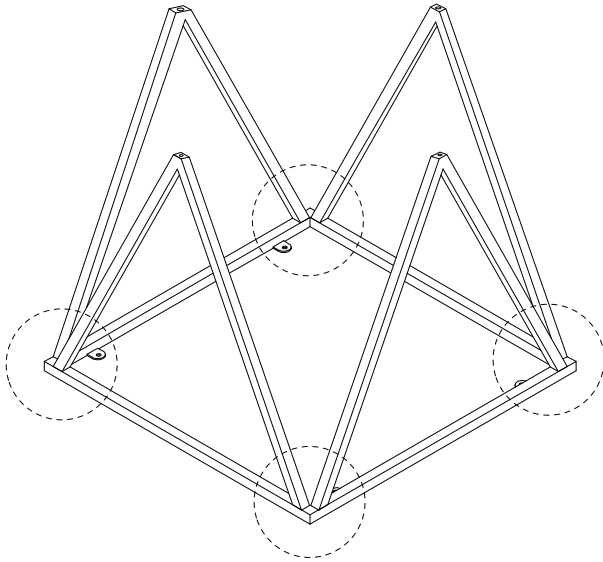
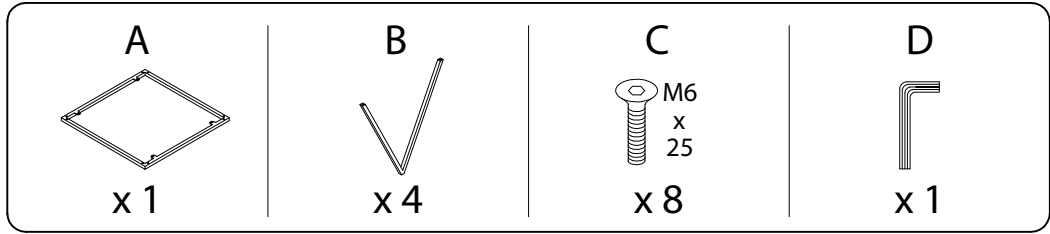

2

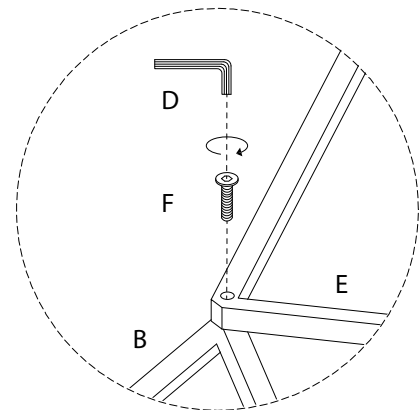
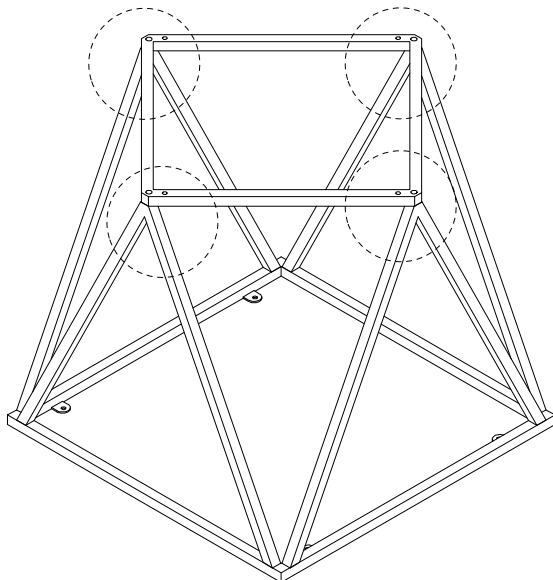
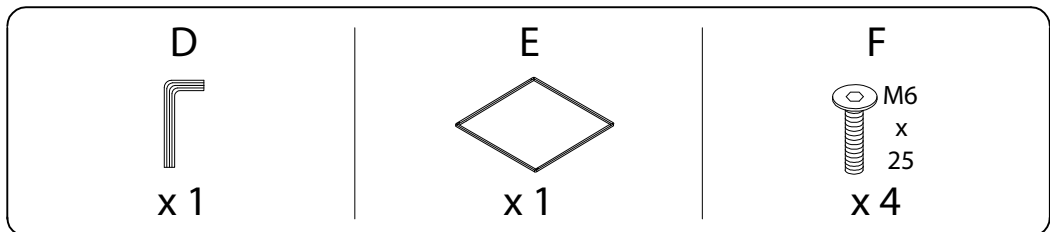

3

G

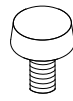

x 4

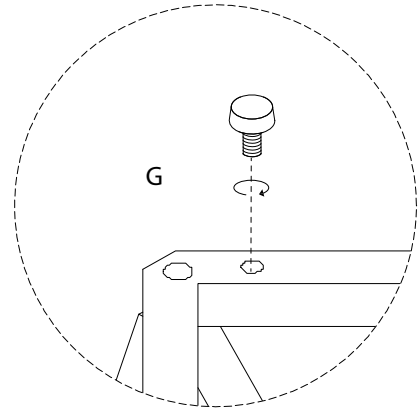
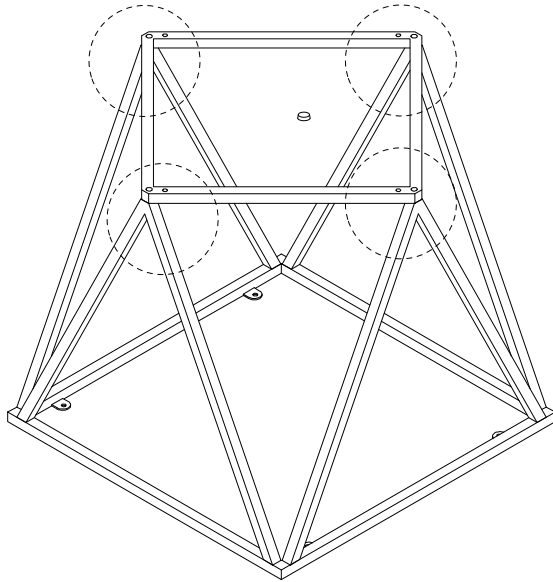

4

H

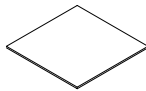

x 1

I

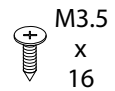

x 4

