

INSTALLATION GUIDE

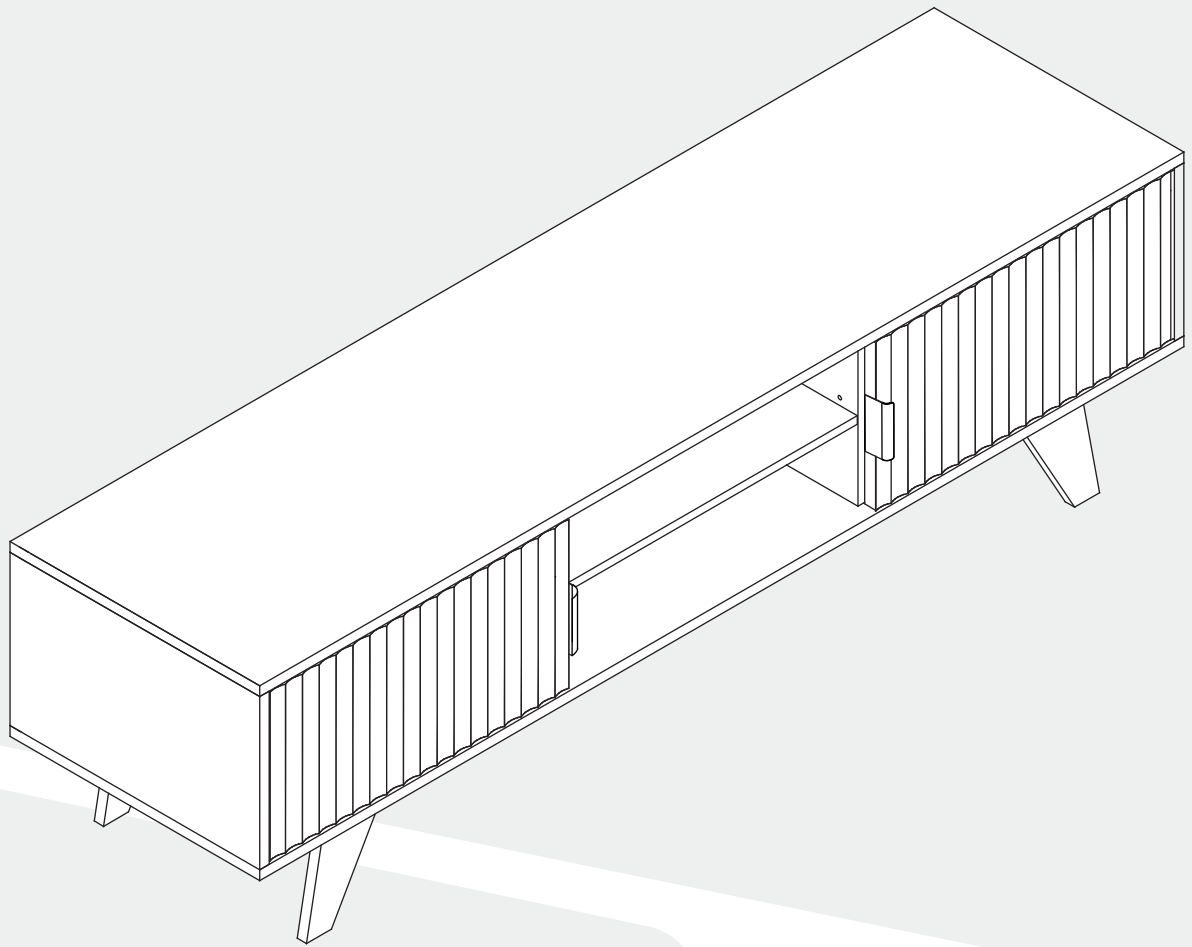

Mid-Century Modern TV Stand



mkxservice@outlook.com

SIZE:

59inch/150cm

70inch/178cm

- I. Ensure that all parts and hardware are available before beginning assembly.
- II. Follow each step carefully to ensure the proper assembly of this product.
- III. Two people are recommended for ease in the assembly of this product.
- IV. The three main types of hardware used to assemble this product are : wood dowels , screws and bolts.
- V. A Phillips head screwdriver is required for the assembly of this product .

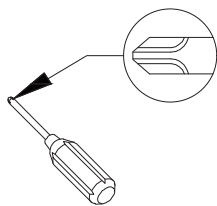

- VI. Power tools should not be used to assemble this product .

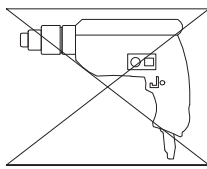

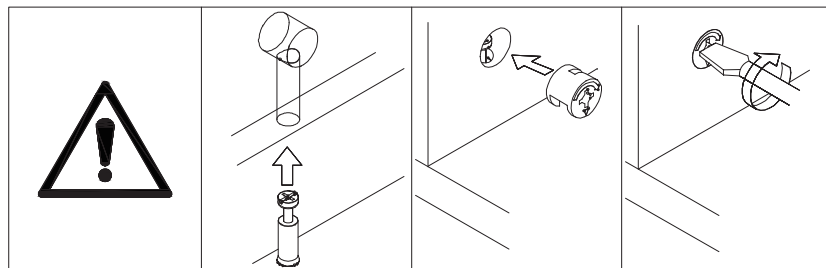
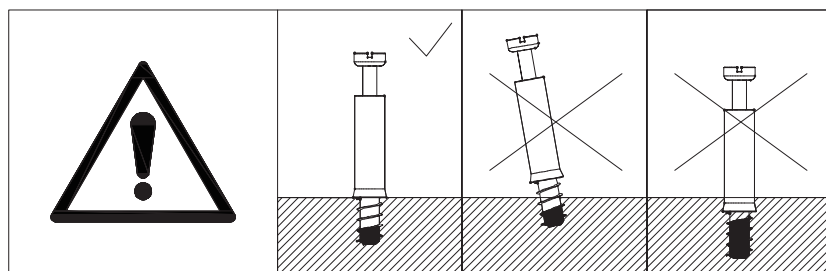

CAM LOCK/BOLT FASTENING INTRODUCTION

(You will use it during assembly)



Cautions

 Ensure that all parts and hardware are available before beginning assembly.

 Follow each step carefully to ensure the proper assembly of this product.

 Two people are recommended for ease in the assembly of this product.

 The three main types of hardware used to assemble this product are : wooddowels , screws and bolts.

 A Phillips head screwdriver is required for the assembly of this product .

 Power tools should not be used to assemble this product .

Vorsicht

 Stellen Sie sicher, dass alle Teile und Metallbauteile bereit sind, bevor Sie mit der Montage beginnen.

 Folgen Sie bitte jeder Schritt sorgfältig, um sicherzustellen, dass das Produkt richtig montiert wird.

 Zur Erleichterung der Montage dieses Produkts wird empfohlen, dass zwei Personen die Montage ausführen.

 Die drei Haupttypen von Metallbauteilen, die für die Montage dieses Produkts verwendet werden, sind: Holzpfosten, Schrauben und Muttern.

 Ein Kreuzschlitzschraubendreher ist erforderlich, um dieses Produkt zu montieren.

 Verwenden Sie bitte keine Elektrowerkzeuge, um dieses Produkt zu montieren.

Précautions

 Assurez-vous que toutes les pièces et les accessoires métalliques sont prêts avant de commencer l'assemblage.

 Veuillez suivre attentivement chaque étape pour s'assurer que ce produit est correctement assemblé.







 Pour faciliter l'assemblage de ce produit, il est recommandé que deux personnes effectuent l'opération.

 Les trois principaux types d'accessoires métalliques utilisés pour assembler ce produit sont : les tiges de bois, les vis et les boulons.







 Un tournevis à croix est nécessaire pour assembler ce produit.

 Ne pas utiliser d'outils électriques pour assembler ce produit.







Precauciones

-  Asegúrese de que todas las piezas y los materiales de metal estén listos antes de comenzar la montaje.
-  Siga cuidadosamente cada paso para asegurar que este producto se monte correctamente.
-  Para facilitar la montaje de este producto, se recomienda que dos personas realicen la operación.
-  Los tres tipos principales de materiales de metal utilizados para montar este producto son: espigas de madera, tornillos y tuercas.
-  Se necesita un destornillador de cabeza Phillips para montar este producto.
-  No utilice herramientas eléctricas para montar este producto.

注意事項

-  組み立てを開始する前に、すべての部品と金具が用意されていることを確認してください。
-  この製品が正しく組み立てられるように、各ステップを注意深く従ってください。
-  この製品の組み立てを容易にするために、2人で作業することをおすすめします。
-  この製品の組み立てに使用される主な3種類の金具は、木製のダボ、ネジ、ボルトです。
-  この製品を組み立てるには、プラスドライバーが必要です。
-  この製品の組み立てには、電動工具を使用しないでください。

주의사항

-  조립을 시작하기 전에 모든 부품과 금속 소재가 준비되어 있는지 확인하세요.
-  이 제품이 올바르게 조립되도록 각 단계를 신중하게 따라주세요.
-  이 제품의 조립을 쉽게 하기 위해 두 사람이 작업하는 것이 권장됩니다.
-  이 제품을 조립하는 데 사용되는 세 가지 주요 금속 소재 유형은 나무 도브테일, 나사 및 볼트입니다.
-  이 제품을 조립하려면 십자 드라이버가 필요합니다.
-  이 제품을 조립할 때 전동 공구를 사용하지 마세요.

Specifications



Environmentally Friendly Wood
The environmental protection grade is E1



Max.Load
66lbs/30kg

★ Caution:

Do not exceed maximum listed weight capacity.

Serious injury or property damage may occur!

überschreiten sie nicht die maximale aufgeführte gewichtsgrenze.

schwere verletzungen oder sachsäden können auftreten!

ne dépassez pas la capacité de poids maximum indicat.

des blessures graves ou des dommages matériels peuvent survenir !

¡no exceda la capacidad máxima de peso indicada.

¡puede ocurrir lesiones graves o daños materiales!

最大の重量制限を超えないでください。

重大な怪我や財産への損害が生じる場合があります！

표시된 최대 중량을 초과하지 마십시오.

심각한 부상이나 재산 피해가 발생할 수 있습니다!

Size Reference

★ NOTE:

If you are not familiar with the size of the screw, you can compare it with the ruler on this page to facilitate your subsequent installation.

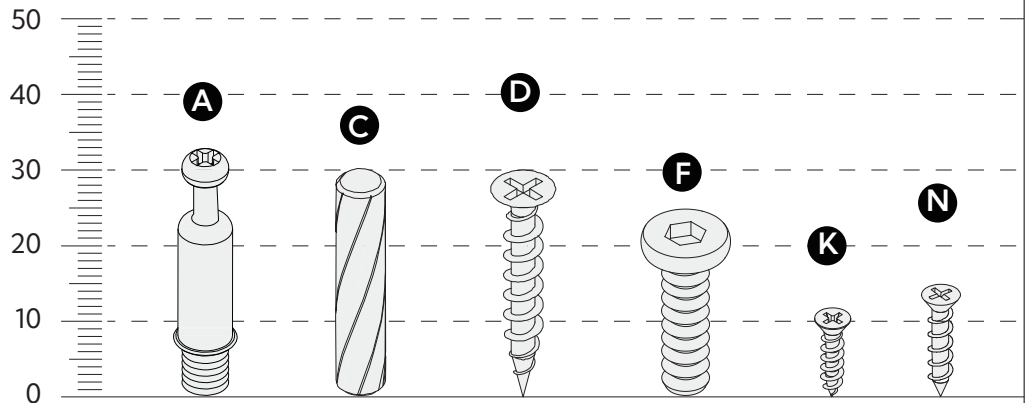

Wenn Sie mit der Größe der Schraube nicht vertraut sind, können Sie diese mit dem Lineal auf dieser Seite vergleichen, um die nachfolgende Installation zu erleichtern.







Si vous n'êtes pas familier avec la taille de la vis, vous pouvez la comparer avec la règle sur cette page pour faciliter votre installation ultérieure.

Si no estás familiarizado con el tamaño del tornillo, puedes compararlo con la regla en esta página para facilitar tu instalación posterior.

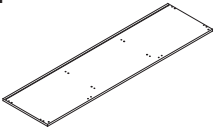
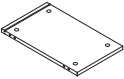
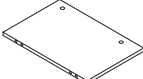
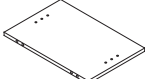
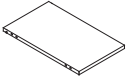
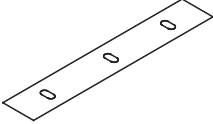
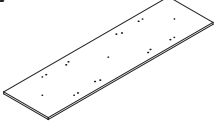
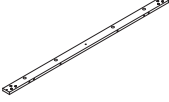



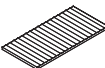





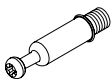

もしスクリューサイズがわからない場合は、このページの定規と比較して後続の取り付けを容易にすることができます。

스크류의 크기를 잘 모르시는 경우, 페이지에 있는 끈 줄기를 비교하여 후속 설치를 편리하게 할 수 있습니다

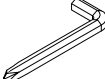
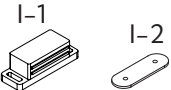
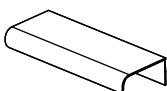
Component List

01  Top Panel (x1)	02  Left Side Panel(x1)	03  Left Vertical Panel(x1)	04  Right Vertical Panel (x1)
05  Right Side Panel (x1)	06  Back Panel (x1)	07  Bottom Panel (x1)	08  Base Front&Back Wood Foot (x2)
09  Base Wood Strip (x3)	10  Wood Leg (x2)	11  Wood Leg (x2)	12  Left Door Panel (x1)
13  Right Door Panel (x1)	14  Movable Shelf (x1)		

Hardware List

A  Cam Bolt M6x33.5mm (x29)	B  Cam Lock M15x9.5mm (x29)	C  Wood Dowel M6x30mm (x20)	D  Screws M4x30mm (x4)
E  Metal Nails (x4)	F  Screws M6x25mm (x12)	G  Pivot (x4)	H  Allen Key (x1)
I  Magnet Latch (x2)	J  Handle (x2)	K  Screws M3.5x12mm (x8)	L  Screws M3x14mm (x4)
M  Mending Wedge (x6)	N  Screws M3x14mm (x6)	O  Foot Sduts (x4)	P  Hole Cover Sticker (x29)

! Note: The numbers 01 to 14 are only for identification purposes and are not labeled. The labels A to N correspond to the fixtures and fittings supplied in the package. In addition, there will be a package of spare parts inside the packaging box.

1

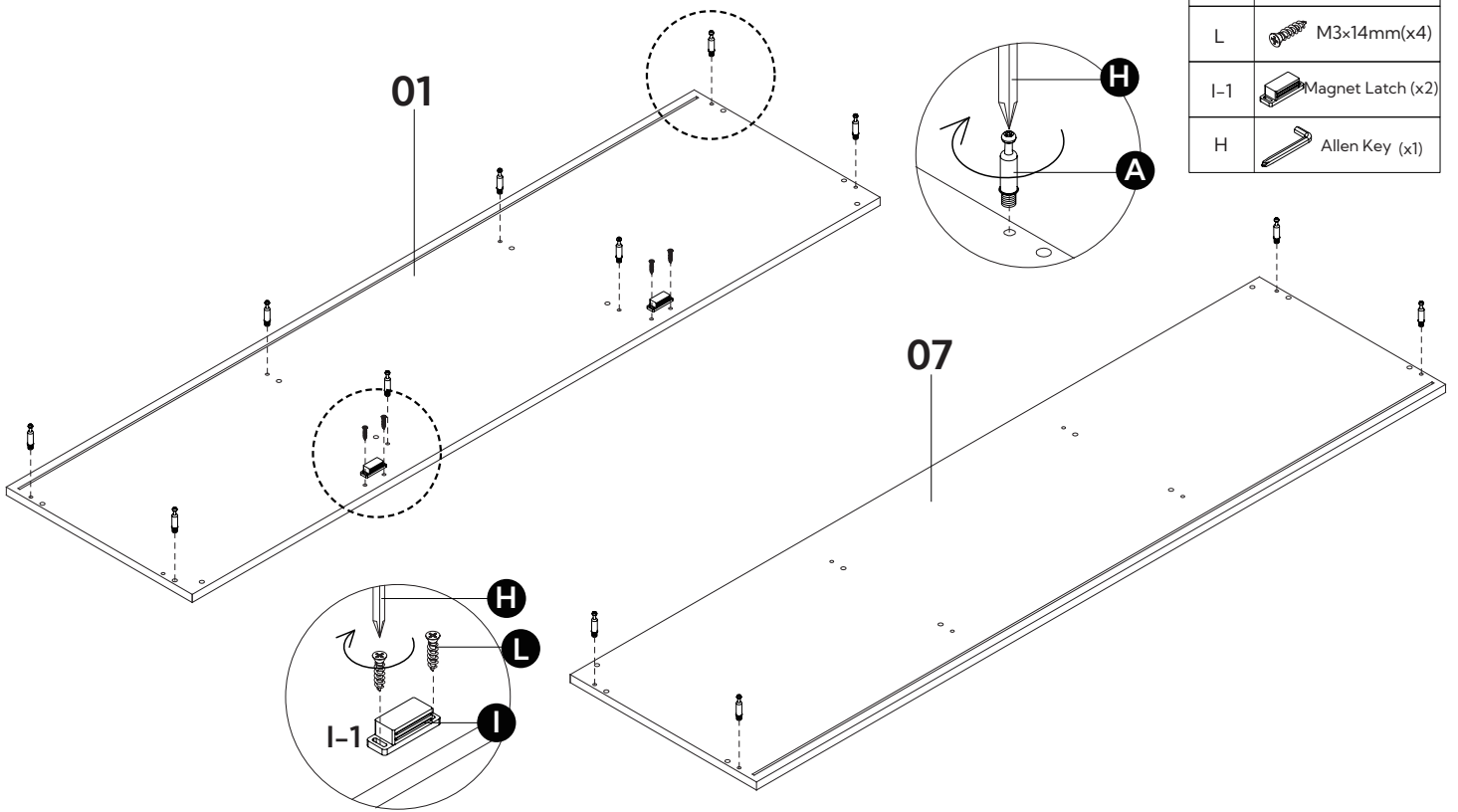

2

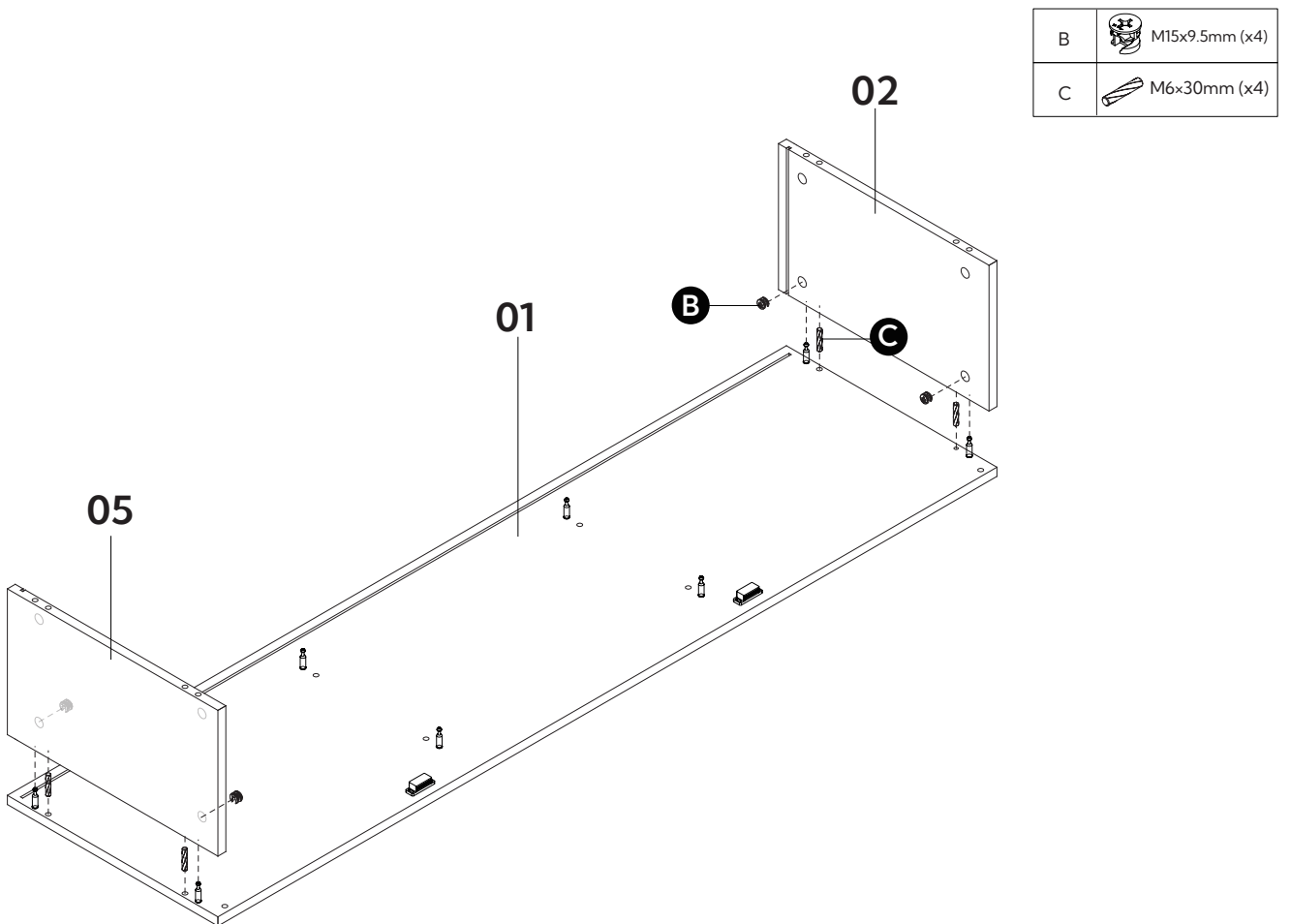

3

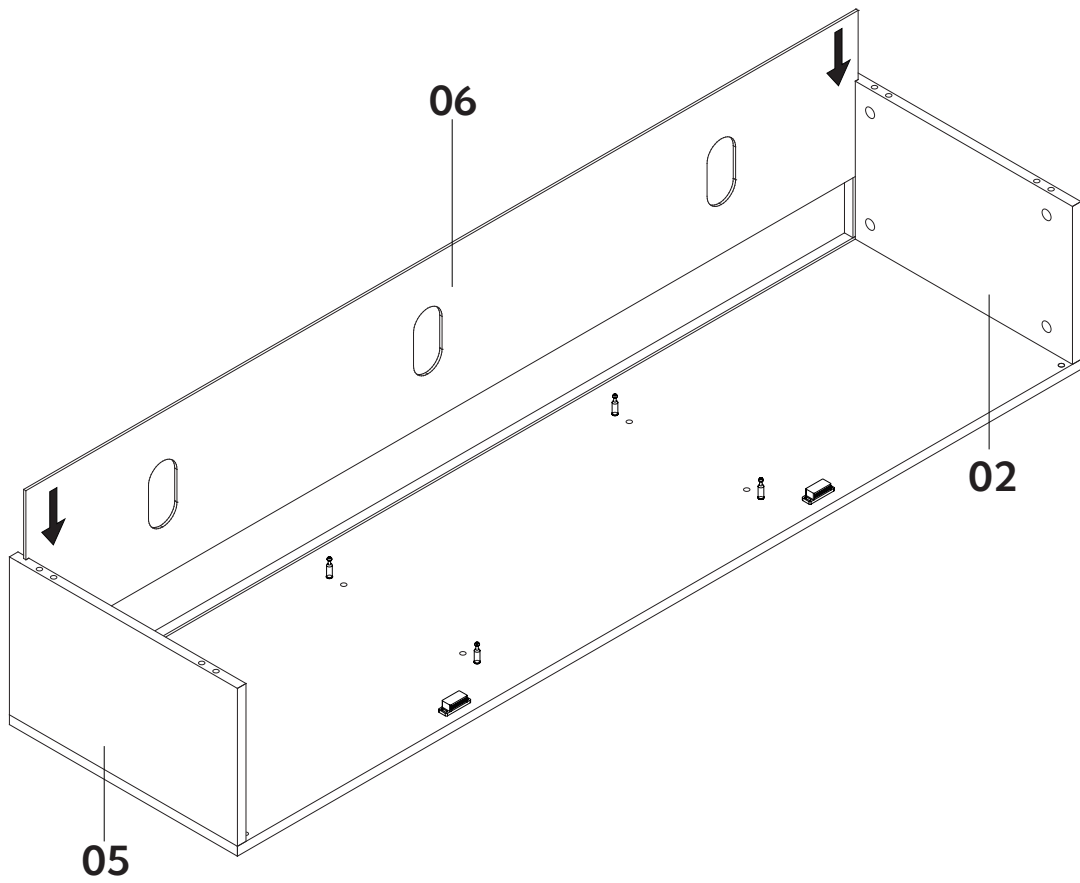

4

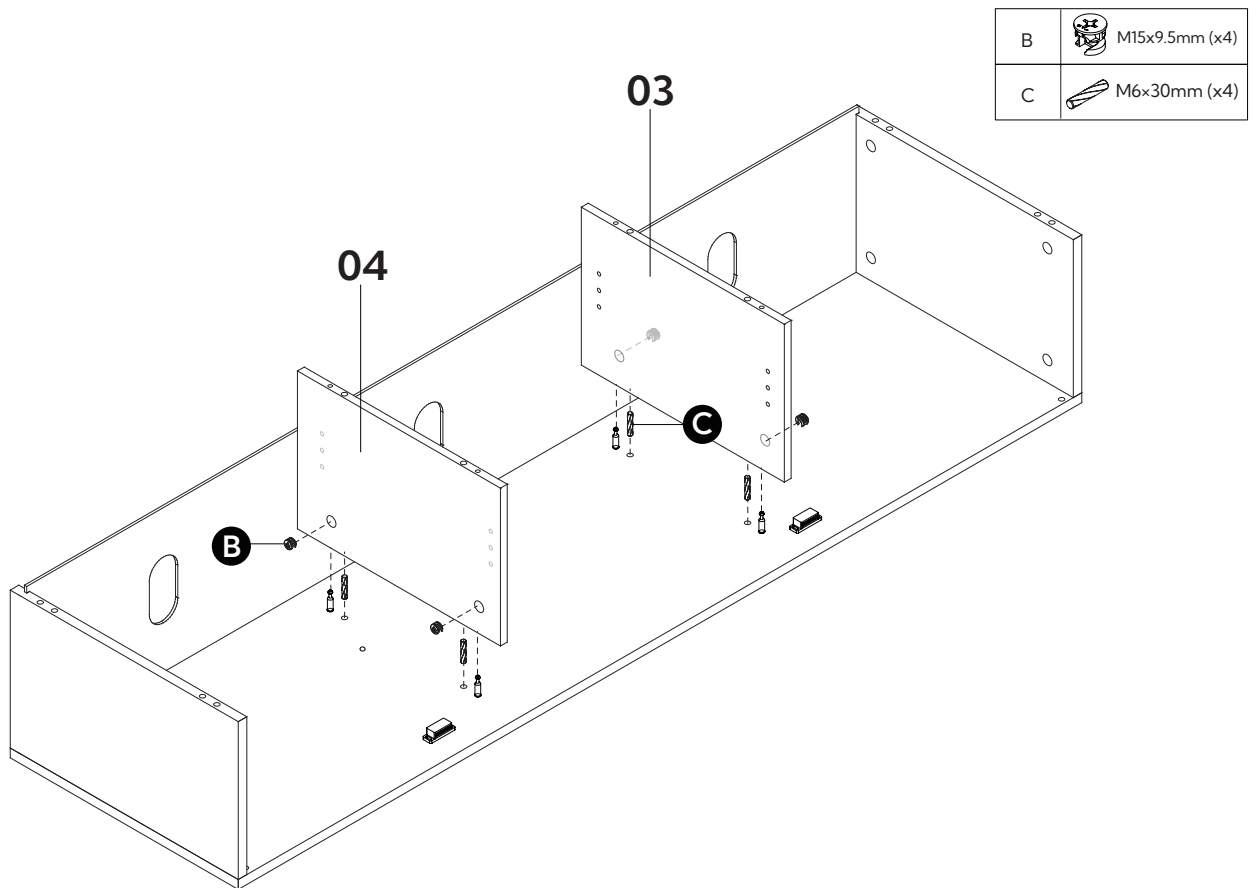

5

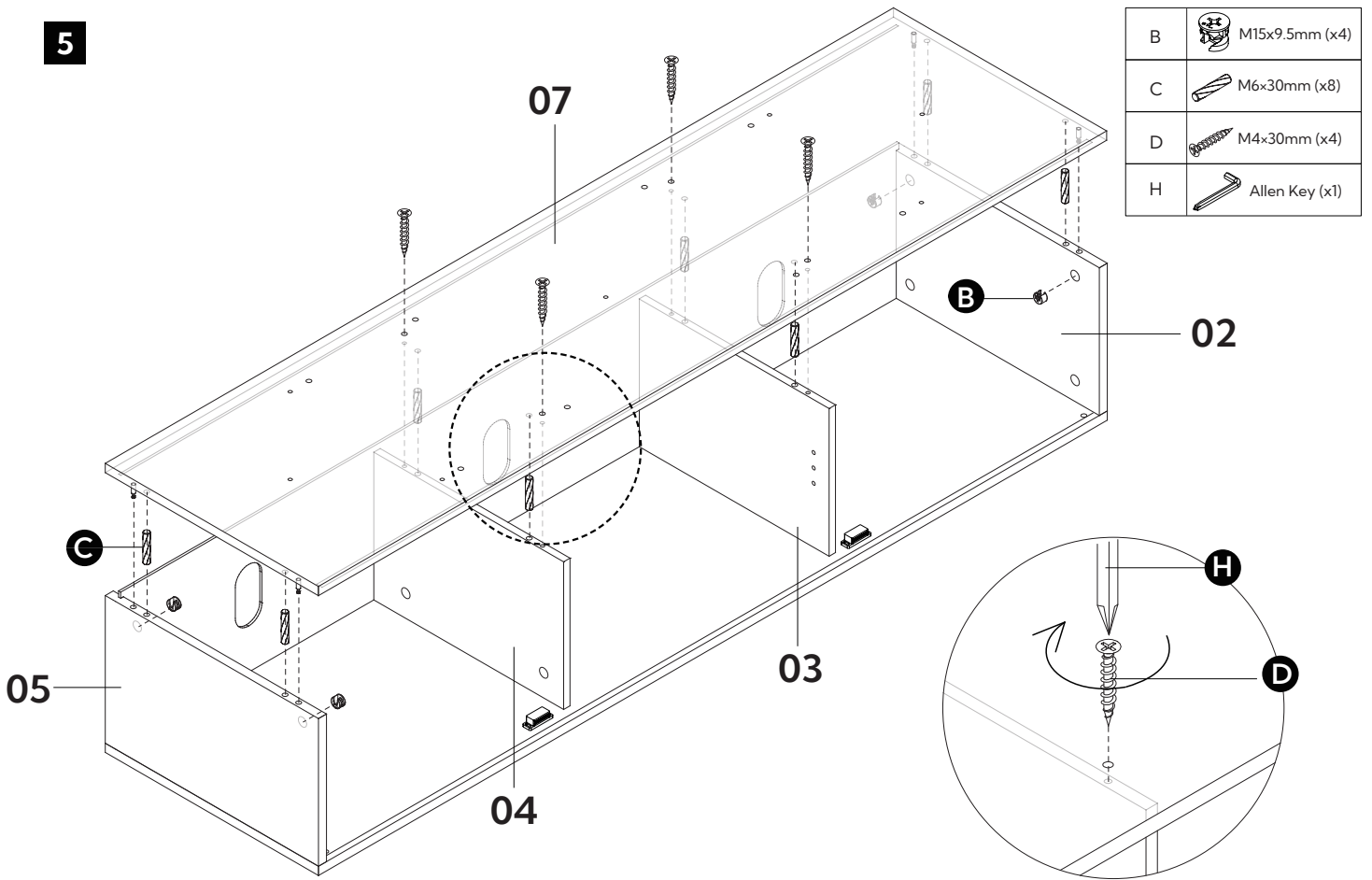

6

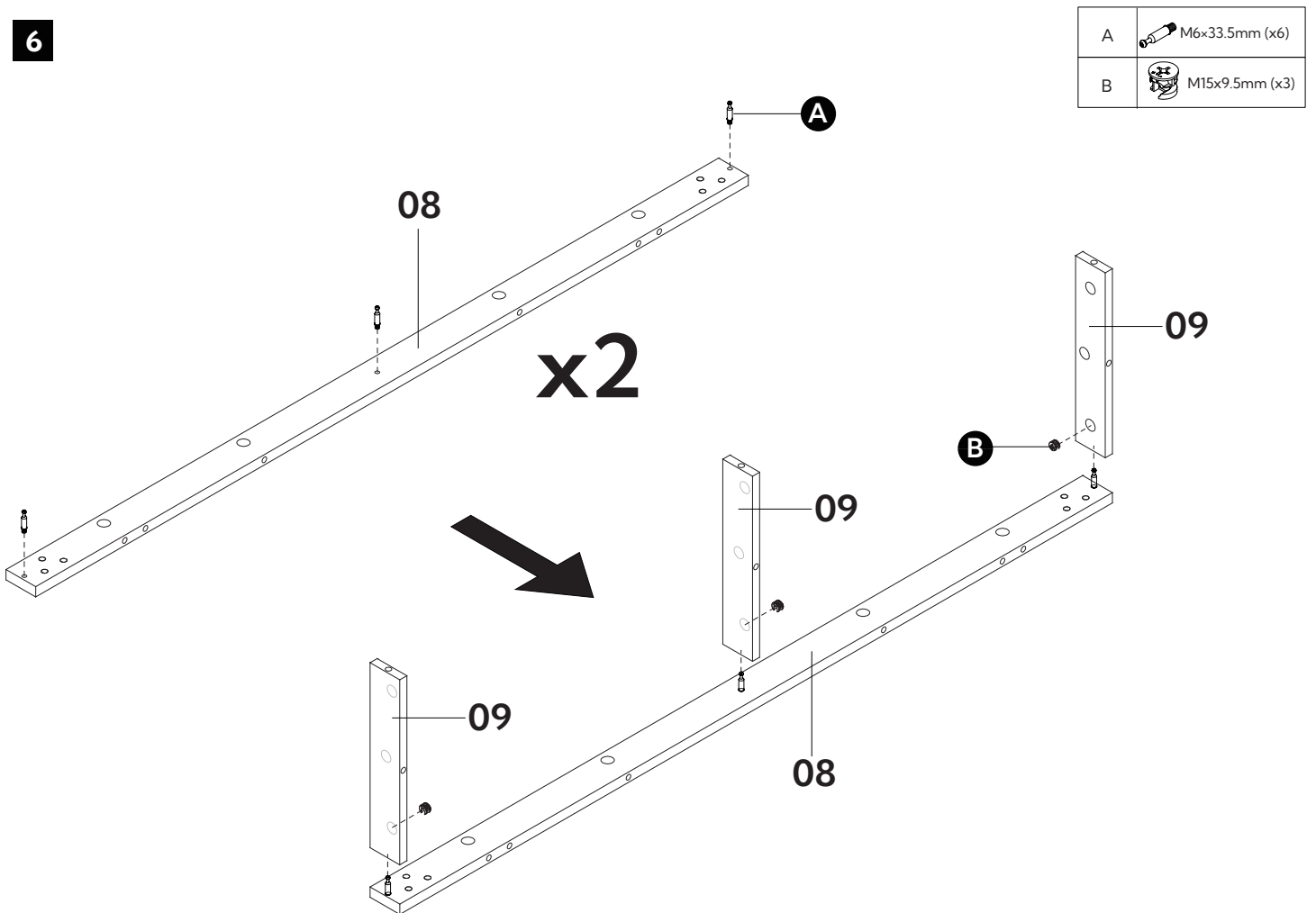

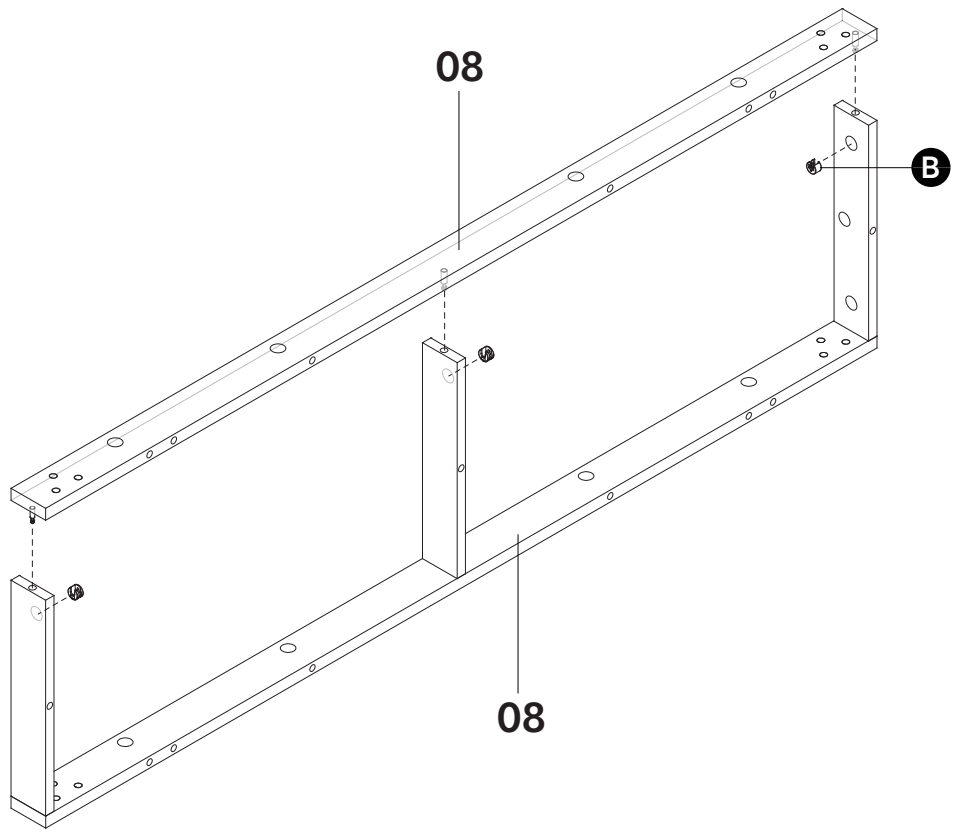

7

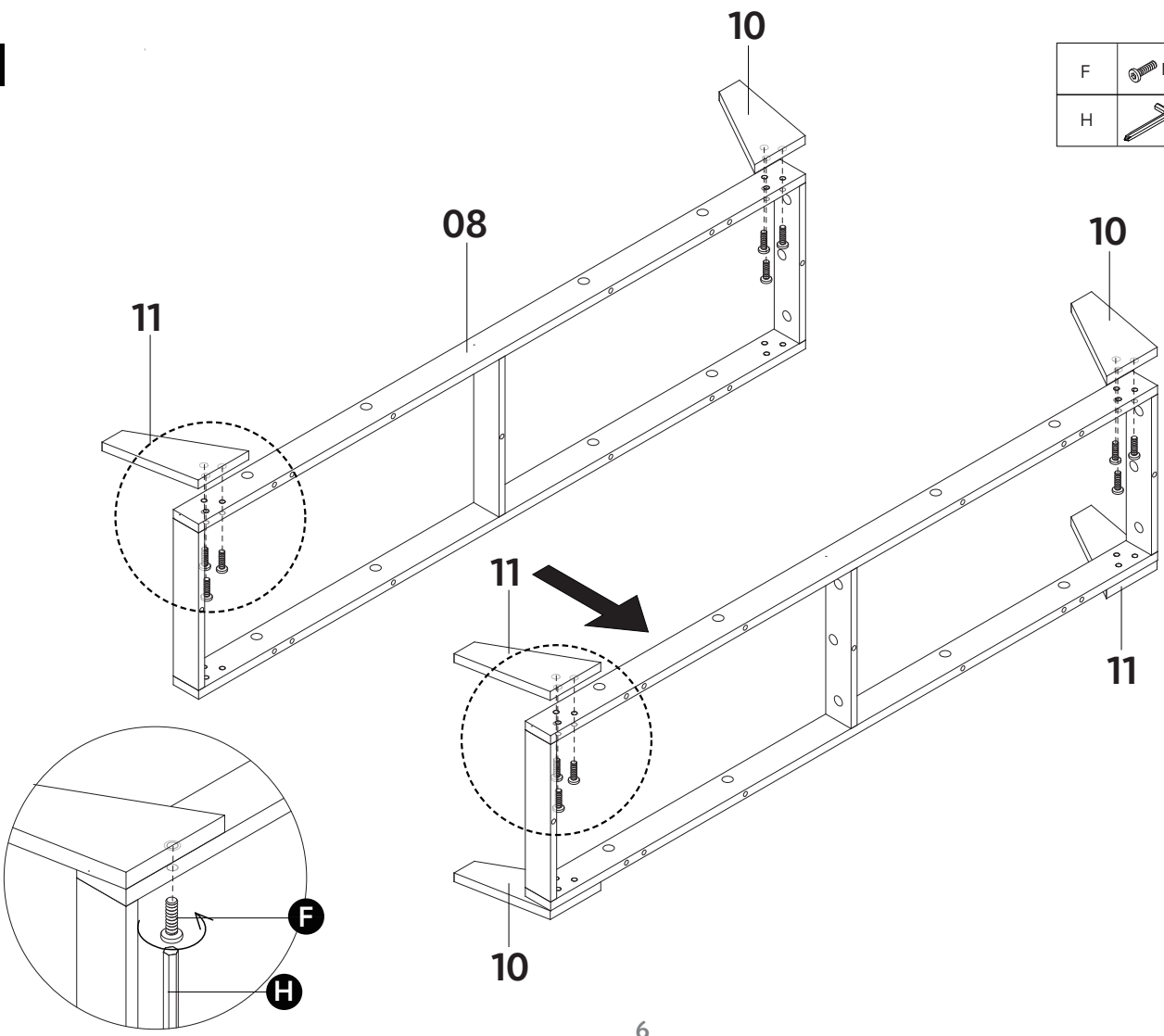

B	 M15x9.5mm (x3)
---	--

8





F	 M6x25mm (x12)
H	 Allen Key (x1)

9

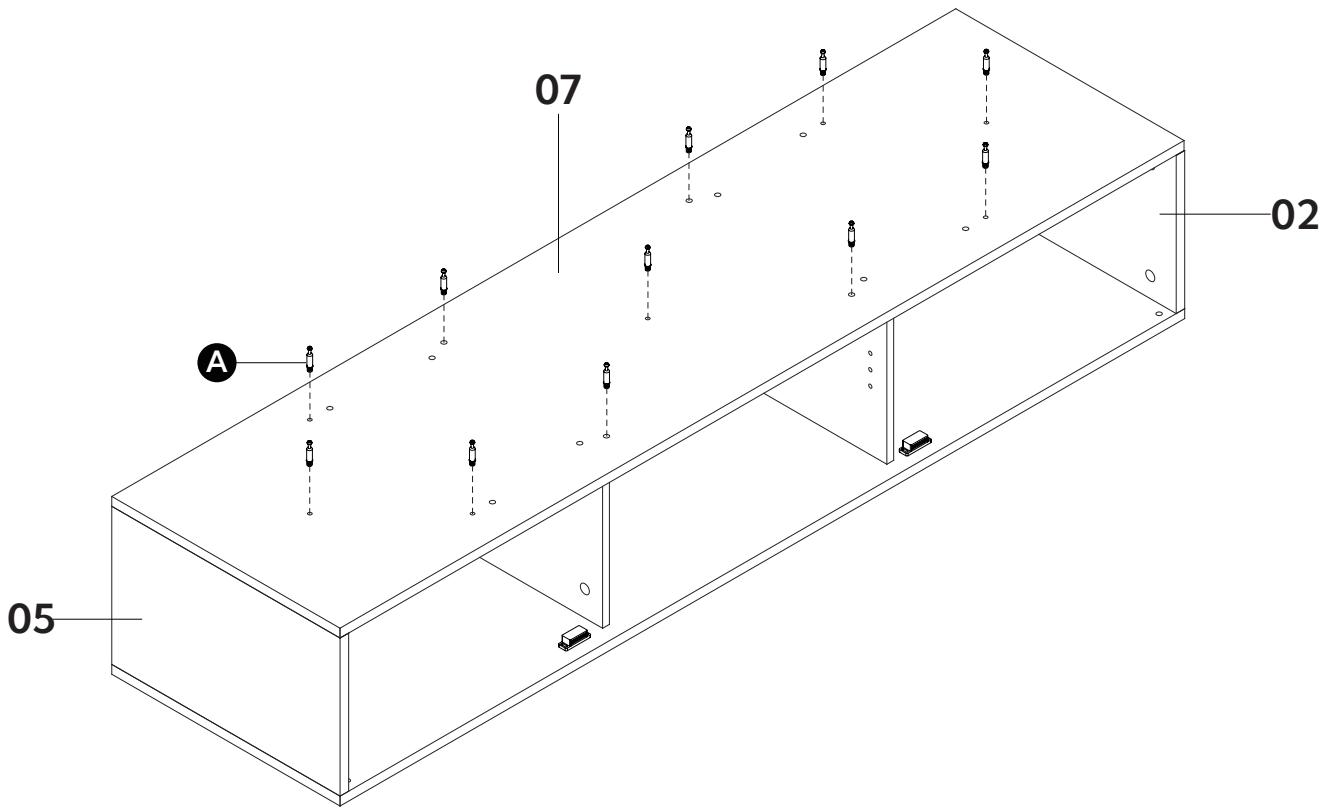
A	 M6x33.5mm (x11)
---	---



10

B	 M15x9.5mm (x11)
C	 M6x30mm (x4)
O	 (x4)

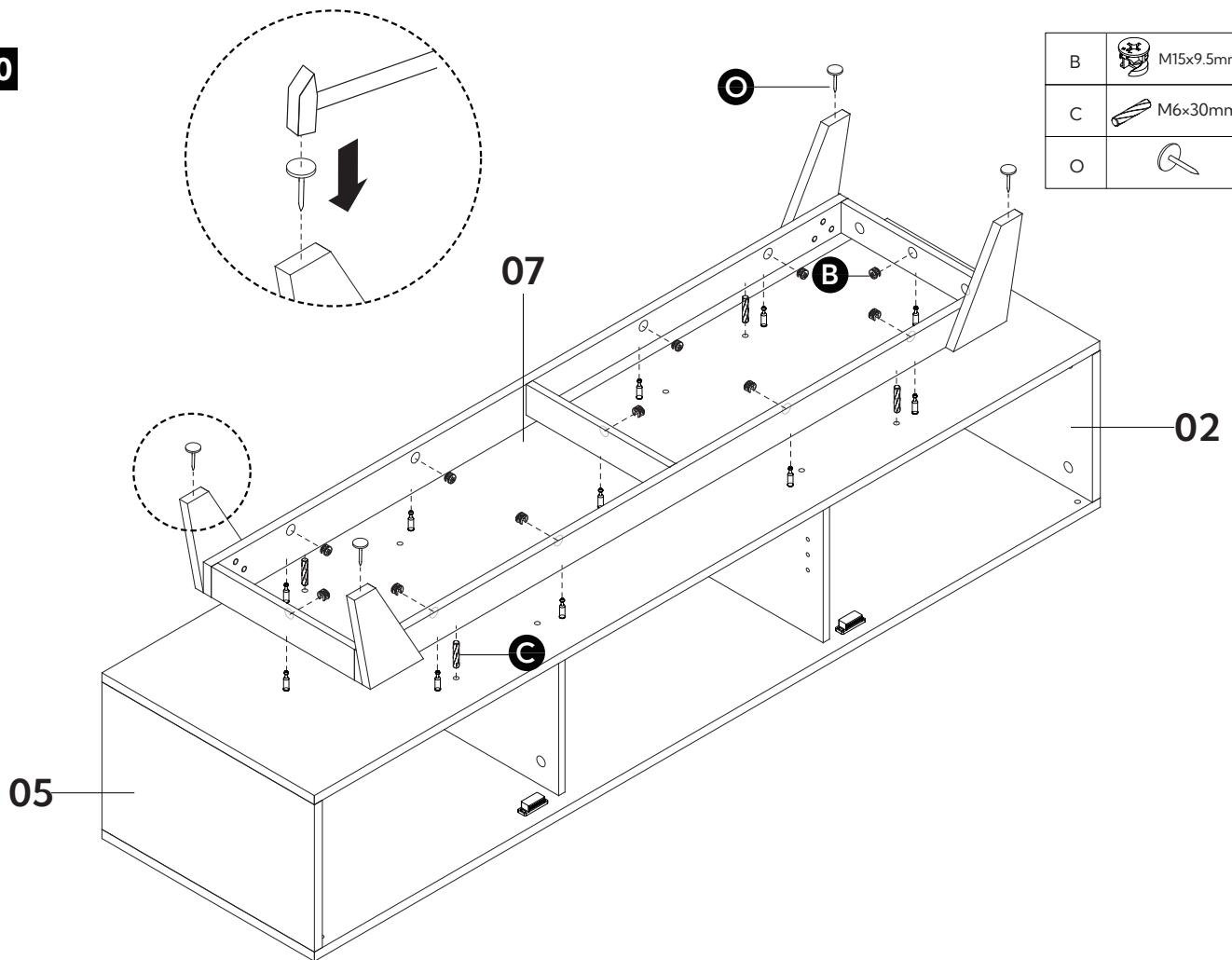

11

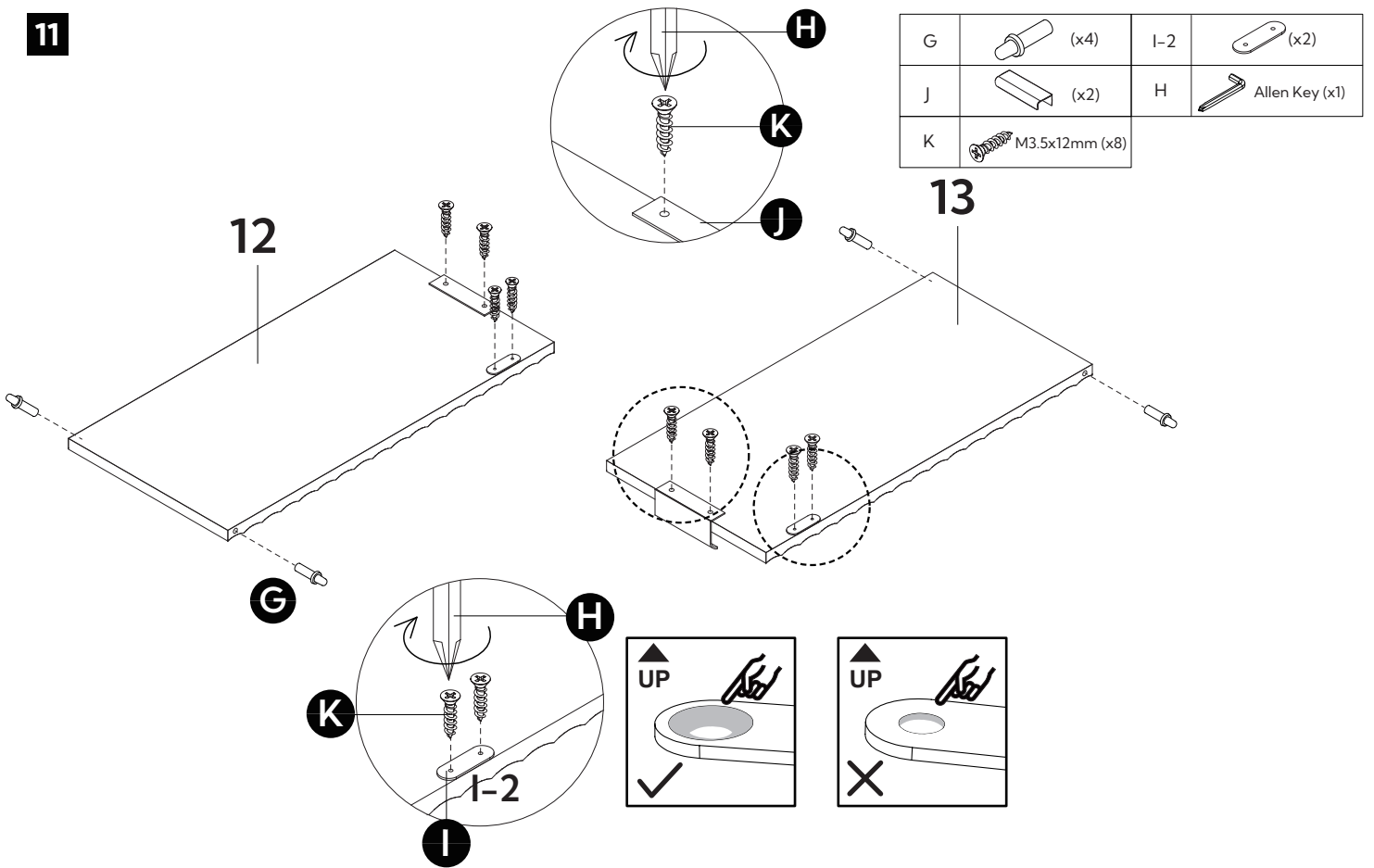

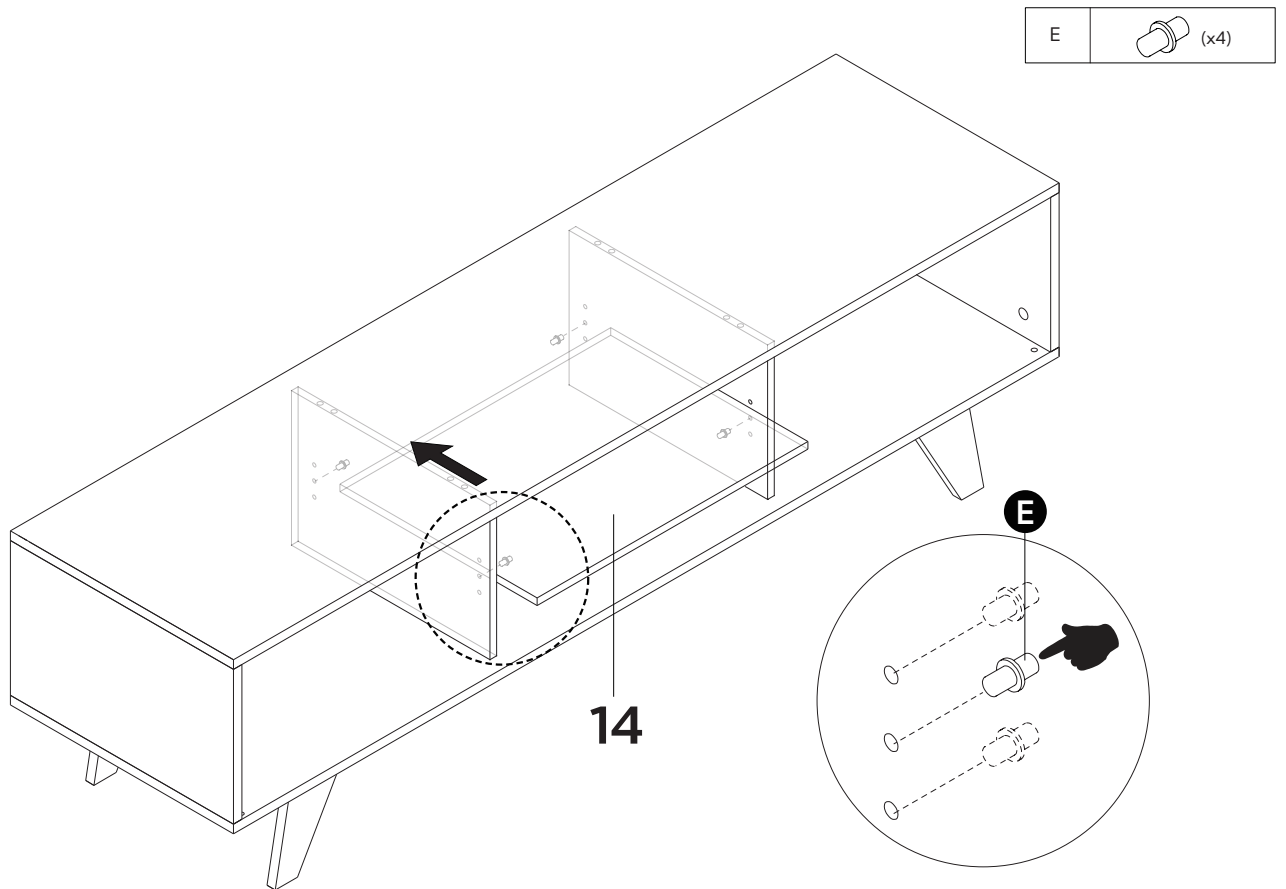

12

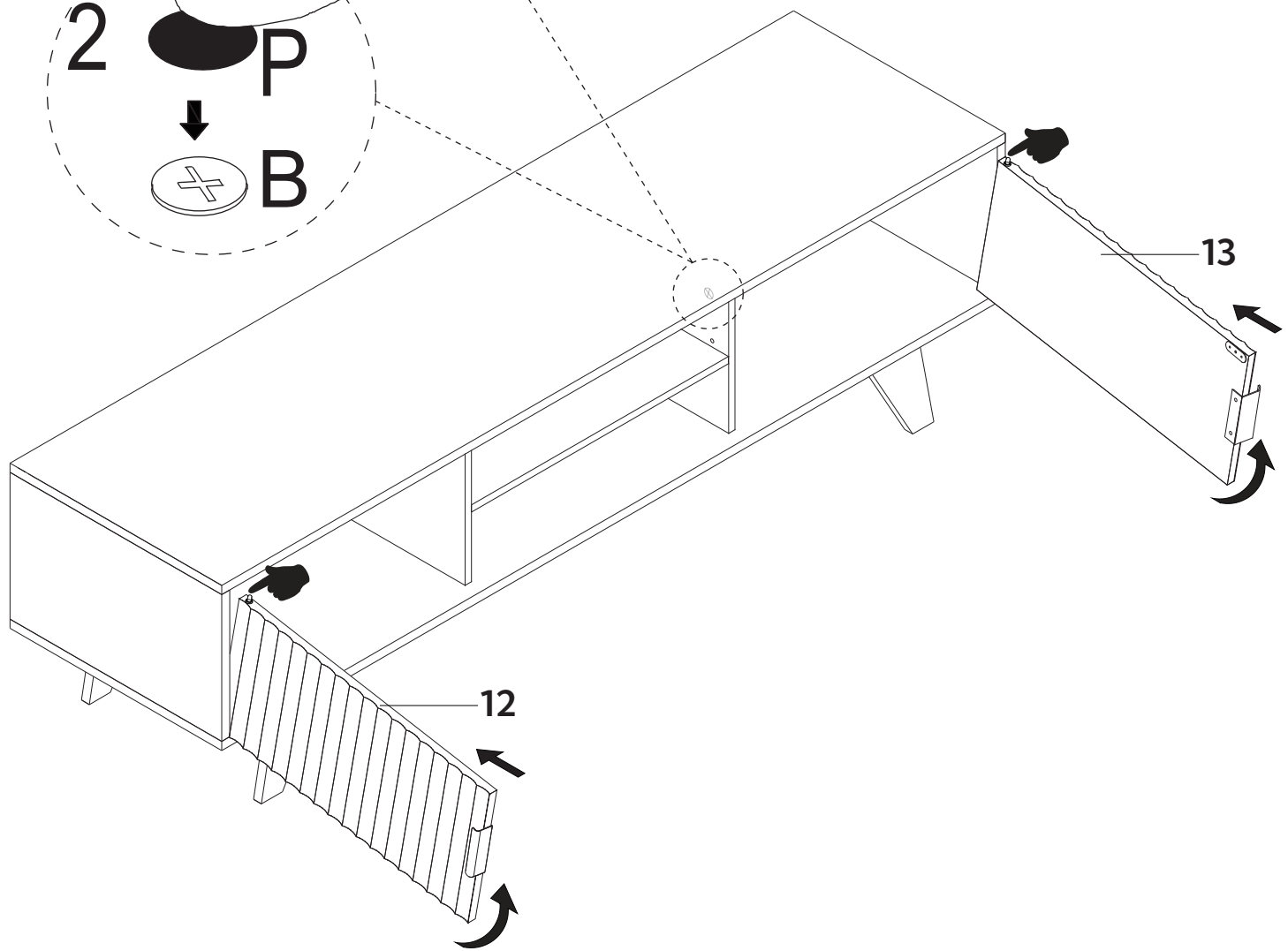
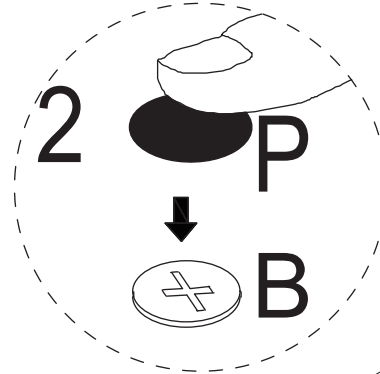
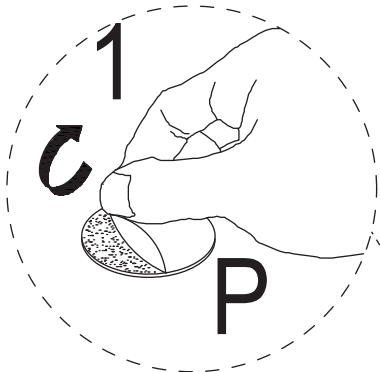

P		(x29)
---	---	-------



M	 (x6)
N	 M3x14mm (x6)

