

ASSEMBLY INSTRUCTIONS

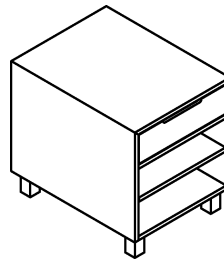

253-915

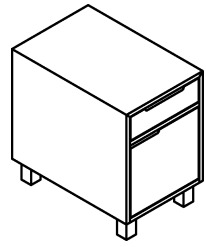

253-916

TOOLS REQUIRED:





BEFORE YOU START:

1. Check the hardware against the hardware list to make sure all items are present.
2. Assemble your furniture on a soft, flat surface to avoid scratching the finish.
3. **CAUTION:** Do not over tighten screws, nuts or bolts during assembly.
4. Your furniture may require occasional tightening.

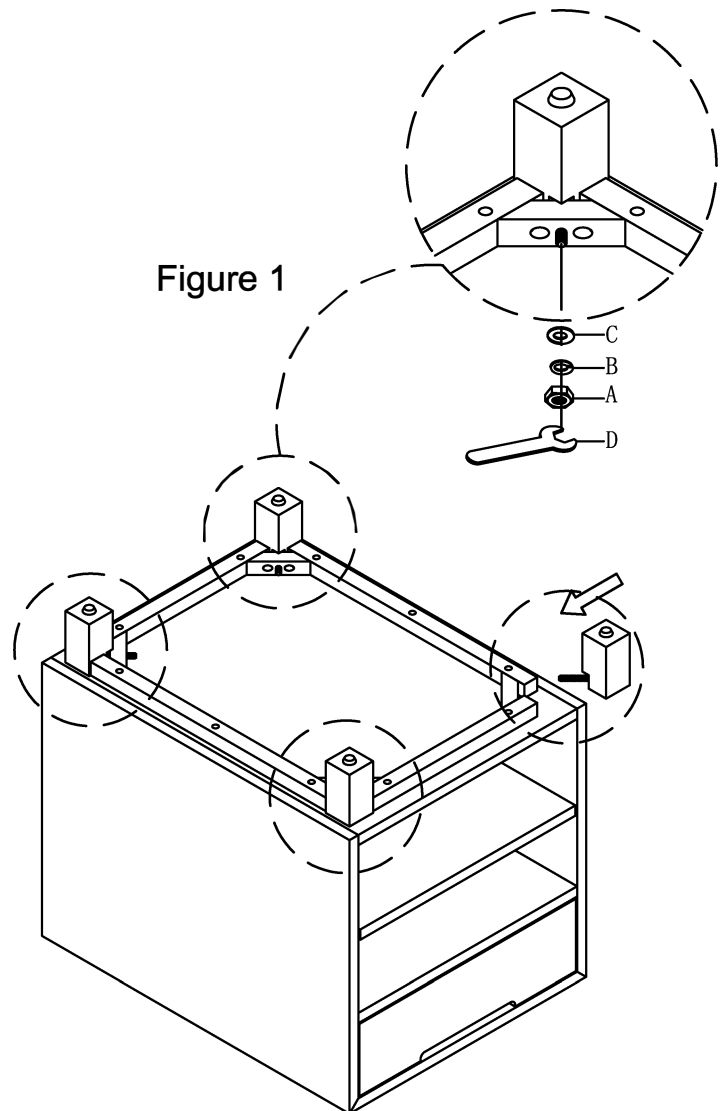
INSTRUCTIONS:

1. Turn the Table upside down on a clean, soft surface.
2. Attach four legs to the bottom of the table, tighten Hex Nut (A) with Lock Washer (B) and Flat Washer (C) by Spanner Wrench (D) as shown in Figure 1.



No.	HARDWARE LIST		Q'ty
A		Hex nut (Ø5/16"x12mm)	4pcs
B		Lock Washer (Ø5/16")	4pcs
C		Flat Washer (Ø5/16"*19*1.5mm)	4pcs
D		Spanner Wrench (Ø12mm*160mmL)	1pc