

# Massage Sofa

---

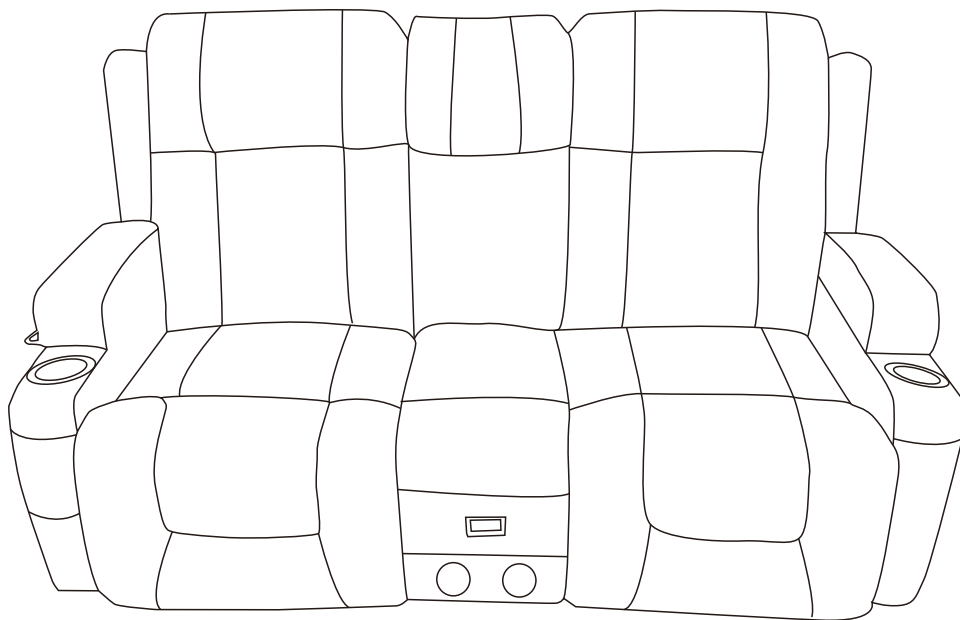

**Note:**

1、 This is a general instruction. Please check your order first, if your order (**without center console**), there is (**no Box D**) in your order. The instruction of the remote control and the warranty policy are at the end.

2、 All accessories are included and no tools are needed. If you have any questions after receiving the sofa, please contact us in time and provide pictures for reference. We will try our best to help you solve it.

3HK7808







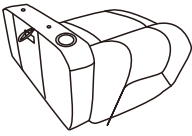

## ! CAUTIONS

- 1、 Please check whether all slots are installed properly, avoid sofa damage and personnel injury caused by abnormal installation.
- 2、 Leave enough 1 ~2 CM between sofa back and wall before recliner, avoid damaging the backrest due to violent tilting.
- 3、 Unplug all power cord and wires connection from socket before moving the sofa. Disconnect all the power when not in use.
- 4、 Don't use the sofa in direct sunlight for a long time to avoid material damage.



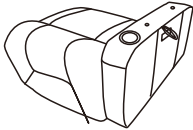
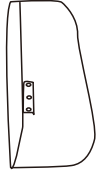

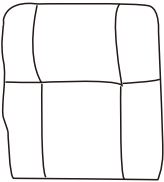
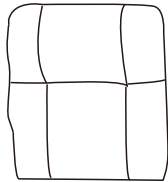
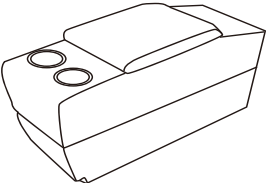



## ! WARNINGS

- 1、 Keep all flame and heat sources away from this massage sofa , avoid the chair burning by accidental contact.
- 2、 Never stand or sit on the edge of the footrest or backrest when the sofa is tilted, avoid safety accidents caused by sofa rollover.

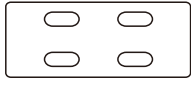
# Parts Listing

BOX-A					
part	Description	Qty	part	Description	Qty
B1		1pc	C1		1pc
D1		1pc	G		1pc
BOX-B					
B2		1pc	C2		1pc
D2		1pc	G		1pc
BOX-C					
A1		1pc	A2		1pc
BOX-D					
F		1pc	E		1pc

# Parts Listing

BOX-C					
part	Description	Qty	part	Description	Qty
1		8pcs	2		4pcs
3		8pcs	4		2pcs
5		1pc	6		1pc
7		2pcs	8		2pcs
9		1pc			

Note: Remaining accessories in Box D

# Step 1

Turn over the base and you will find that the power cord and LED Light connection are binding by four cable ties. Please cut off # 1# 2# 3# 4 cable straps.

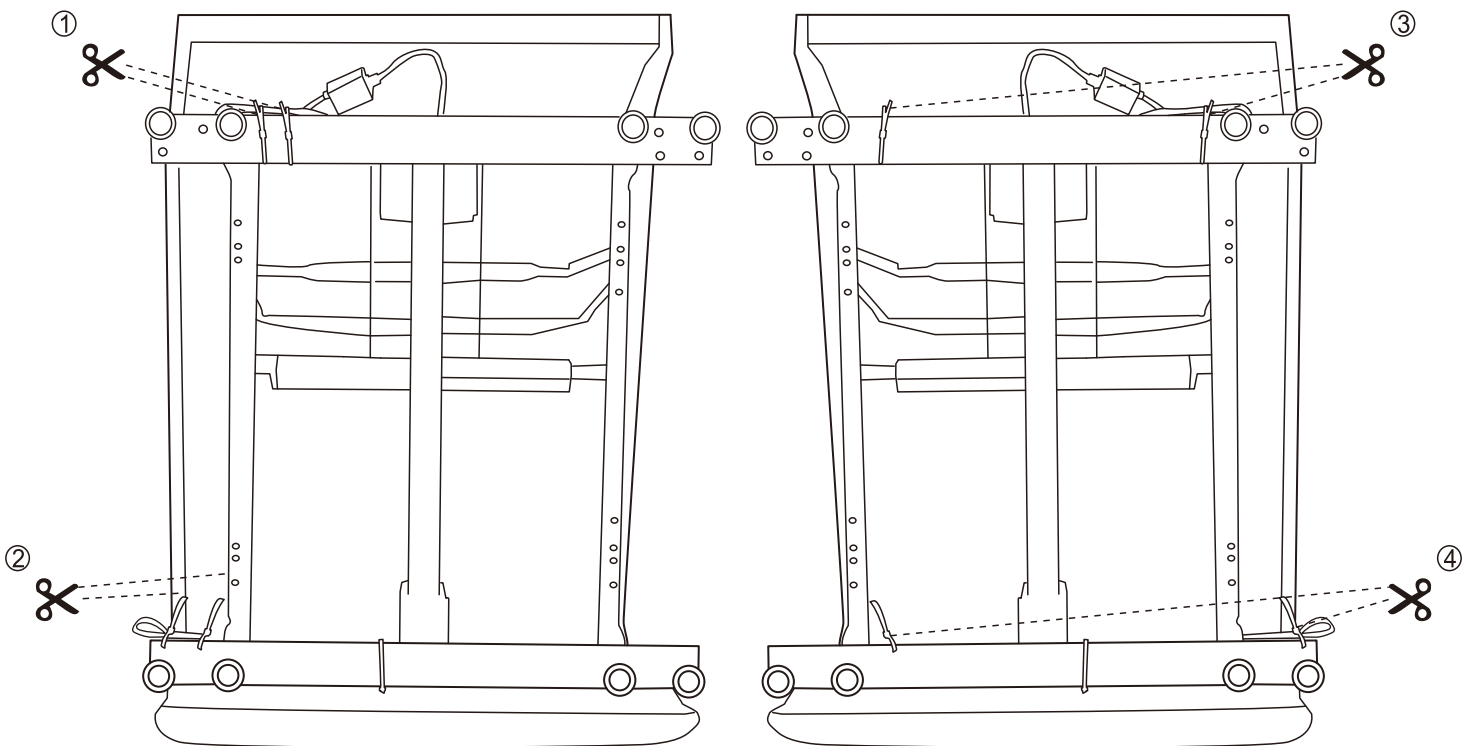

## Step 2

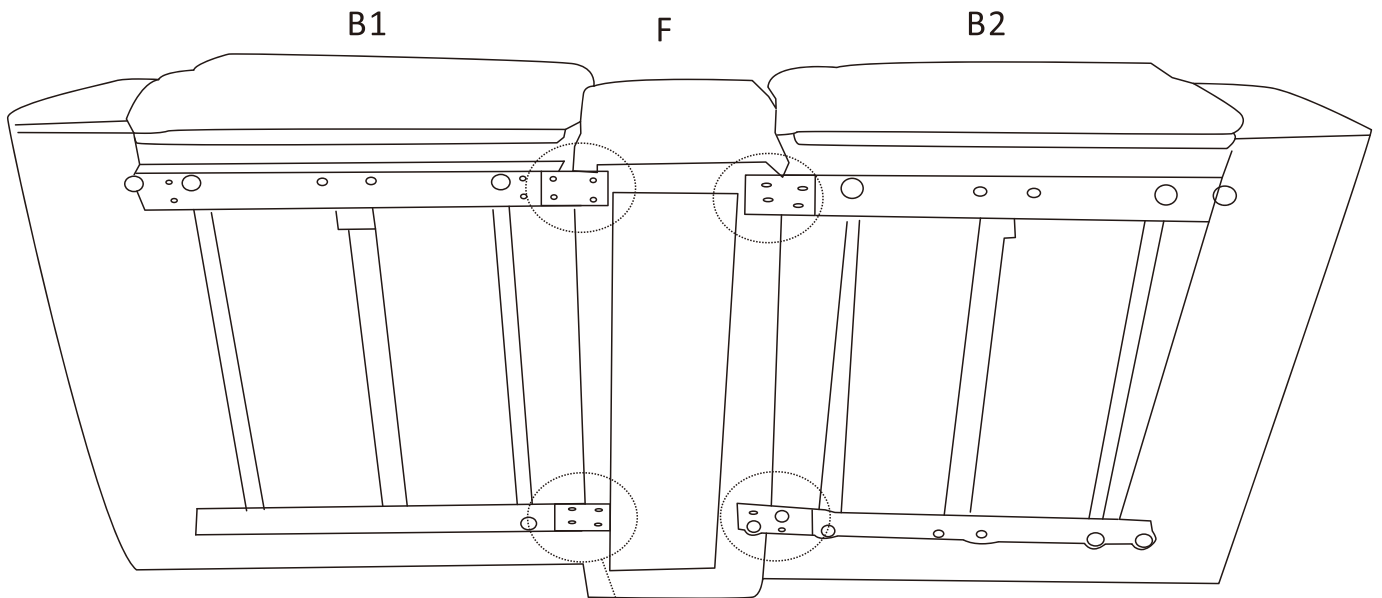

**Note:**

Part 5 is used to fix the Part 4 near the bases.

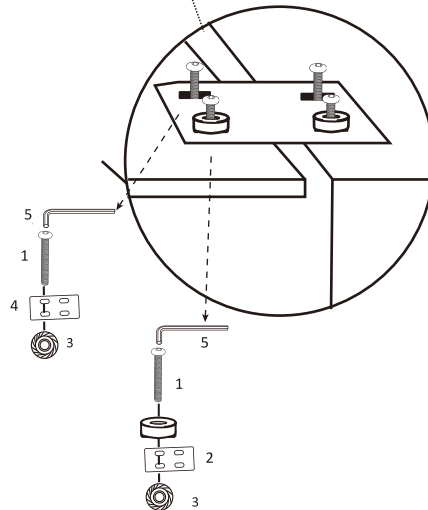

Accessories: Part 1\*16; Part 2\*8; Part 3\*8; Part 4\*4

Operating Procedure:

Connect the Part B1/B2/F by using the Part 4. For the convenience to adjust parts connection, never fully tighten the screws until you finish the installation, tighten screws to 80%-90% is enough.

## Step 3

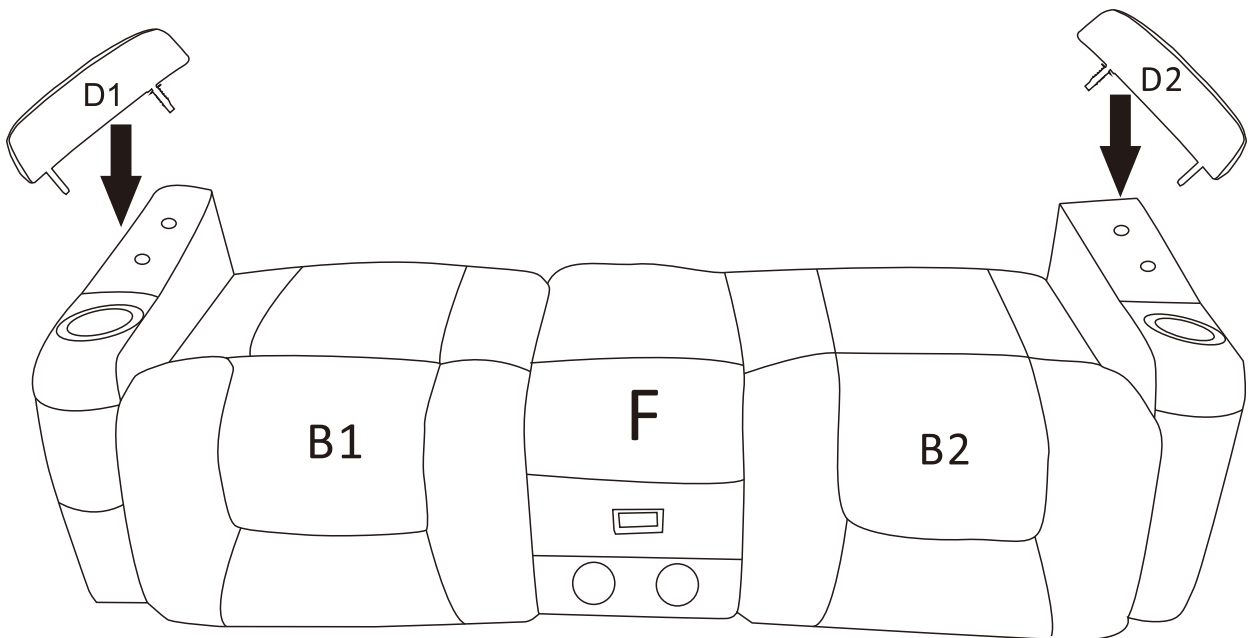

Accessories: Part D1\*1 Part D2\*1

Operating Procedure:

Please align the plug-in components of the left and right armrests(D1 and D2) with the holes on the base and insert them.

## Step 4

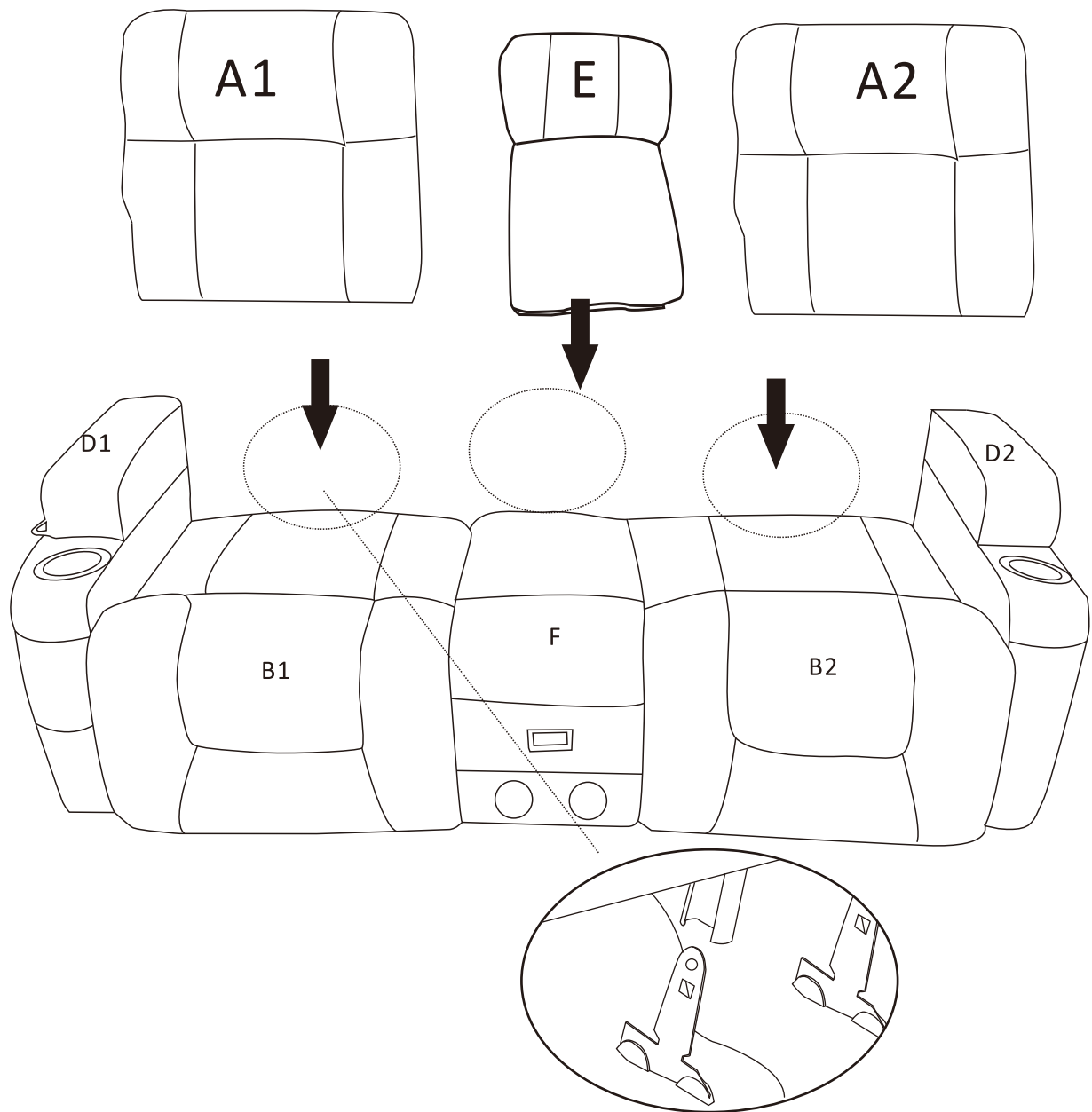

Accessories: Part A1\*1 Part A2\*1

Operating Procedure:

Align the backrests(Part A1 Part A2) with the slot on the bases (Part B1 Part B2) separately and insert them firmly, when you hear a click that's correct installation.

## Step 5

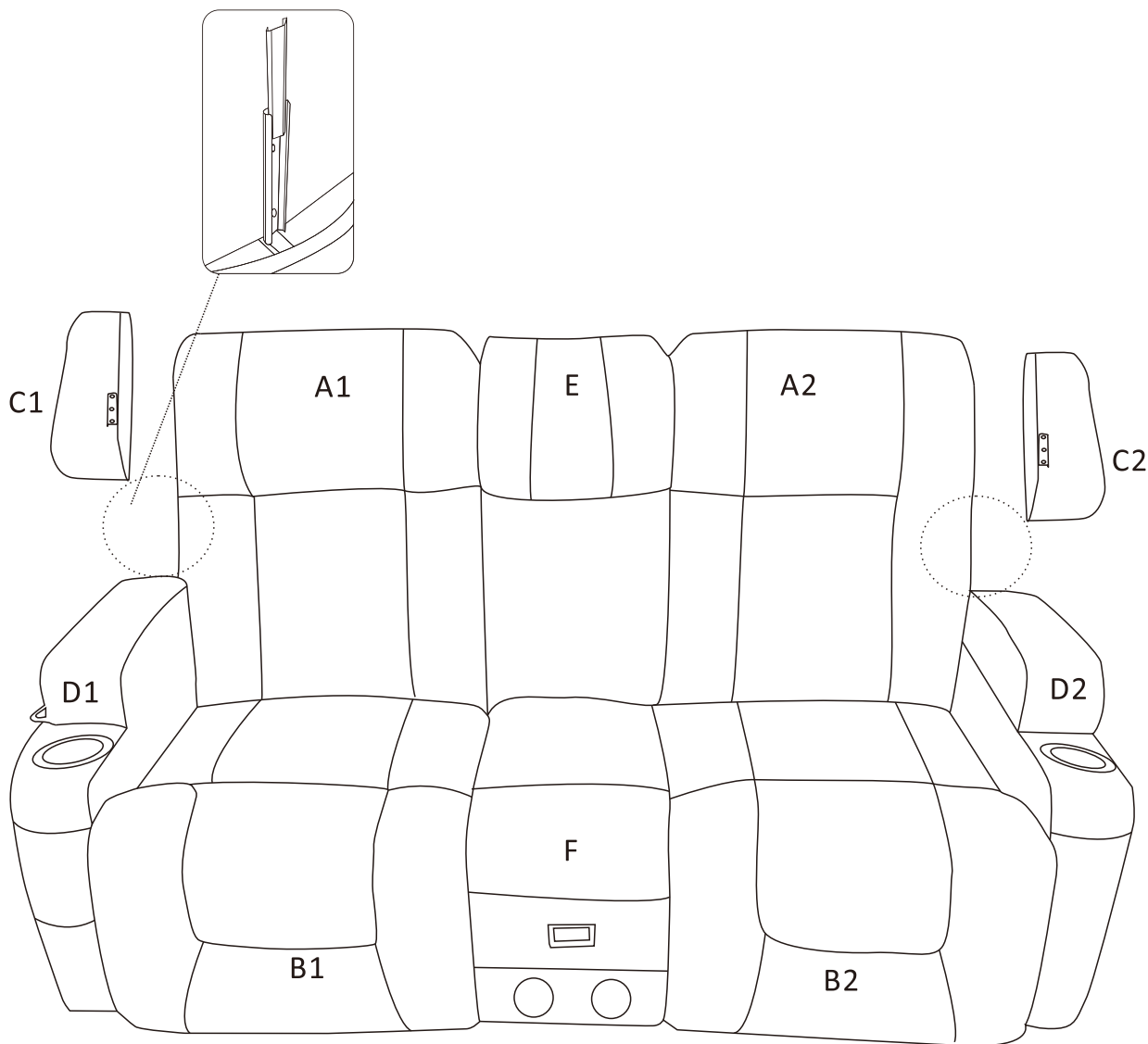

Accessories: Part C1\*1 Part C2\*1

Operating Procedure:

Align the Part C1 and Part C2 with the slot on the backrests (Part A1 Part A2) separately and insert them firmly.

## Step 6

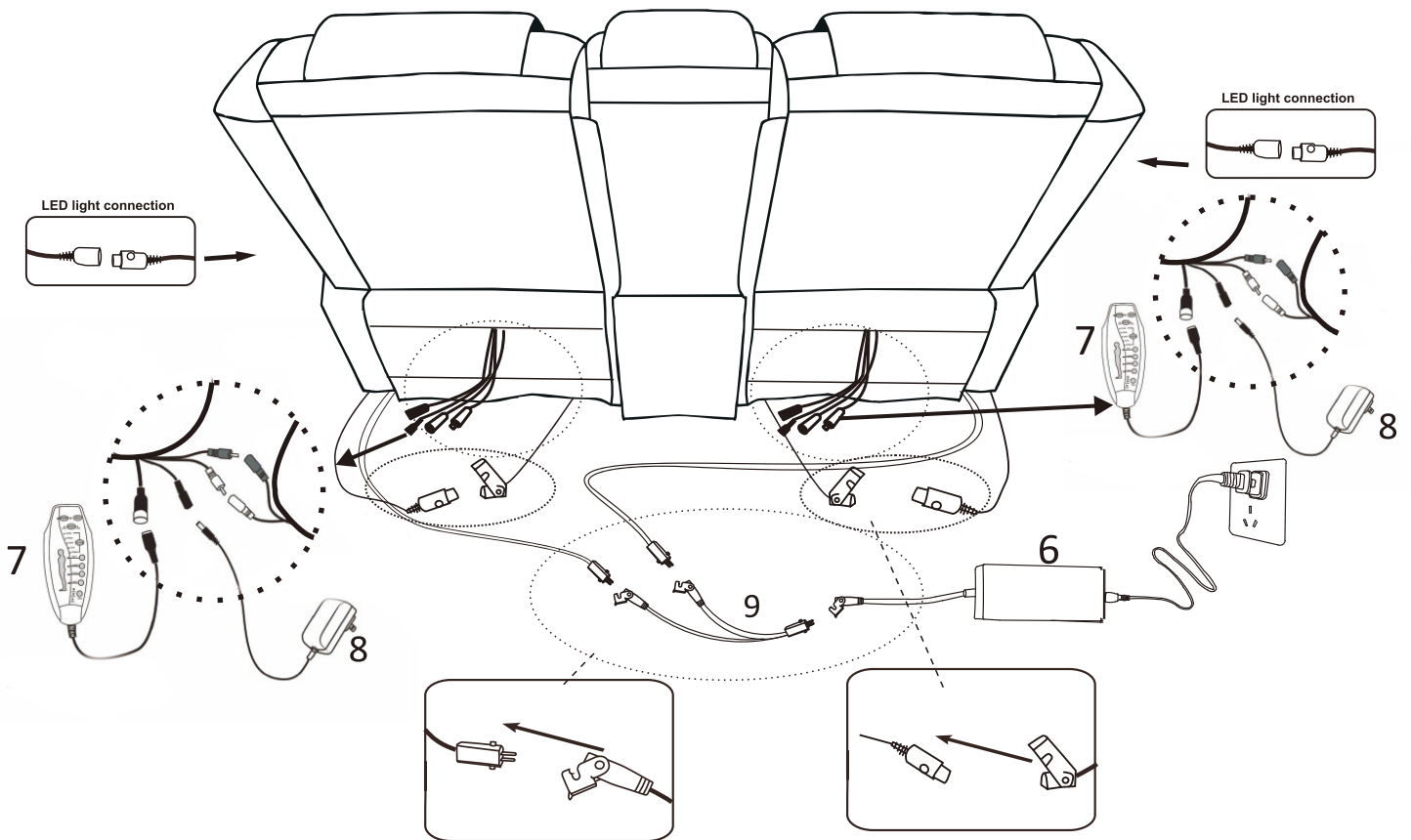

Accessories: Part 6\*1 Part 7\*2 Part 8 \*2 Part 9 \*1

### Operating Procedure:

- 1、 Connect the red and white wires on the backrest and the base , red to red and white to white.
- 2、 Connect the other two wires behind the backrest with Part 7 and the Part 8 separately.
- 3、 Connect the wire attached to the base frame with the wire on the armrest.
- 4、 Connect the other wire attached to the base frame with Part 9 for controlling tilt function, and then use the Part 8 to connect Part 9 , then plug it in and start using it.

# Functional instruction

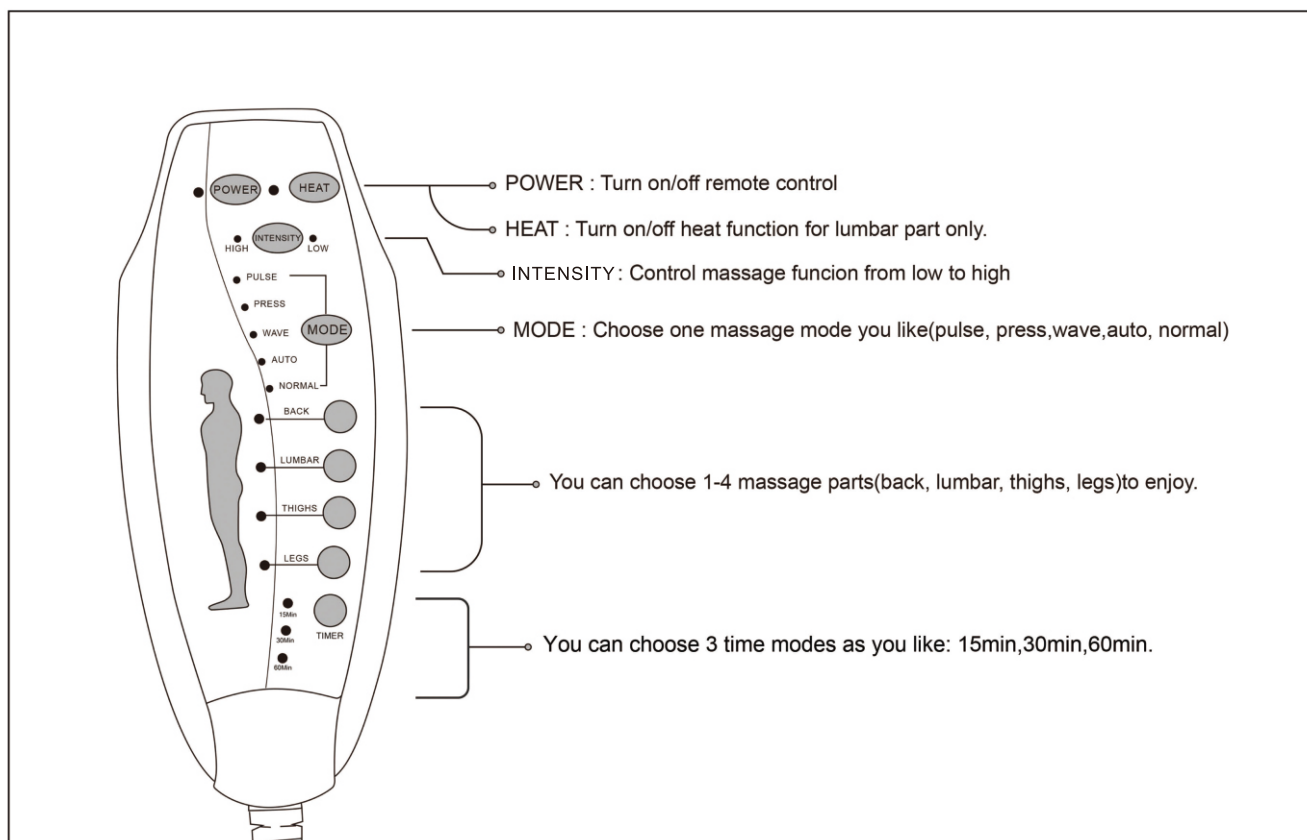

## Note:

- 1、 When you turn on the power, the massage points may all be turned on, you can manually select the massage points.
- 2、 This sofa has a self-protection system,it may automatically turn off after 15 minutes, please don't worry, you can restart again to choose the time of massage heating.

## WARRANTY

- The quality of our products has been strictly controlled. Each stage of the product upgrading has condensed the efforts of employees in various departments. We strive to minimize the probability of failure of new products and insist on providing customers with worry less after-sales service.
- If you have any damage or quality problems after receiving the goods, please contact us in time, our professional after-sales team will reply you as soon as possible and help you solve it.
- In order to save your time, please describe the problem in detail. If possible, we hope you can upload product pictures for our reference, and inform us the part number according to the instructions.

## AFTER-SALE POLICY

In order to better provide after-sales service experience, we provide the following after-sales policies. At the same time, we also hope that you can actively cooperate with us.

- Within the warranty period of the product, In case of product quality problems, you can contact us, we can provide you with parts replacement services, but for functional issues, we hope you could cooperate with us to complete the troubleshooting steps we told you and inform us the result,so we could help you solve it.
- For the return problem, we do not accept unreasonable refunds. If you are not satisfied within 3 days after receiving the goods, we hope you can contact us as soon as possible. After we checked, you must return the product in their original status, so you could qualify for a refund.

# Warning

Do not sit/kick/stand on the footrest after lift up

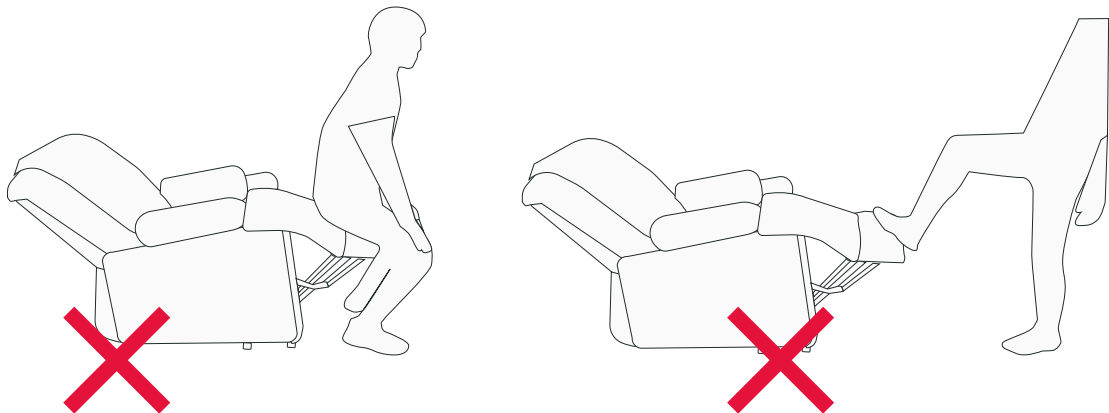
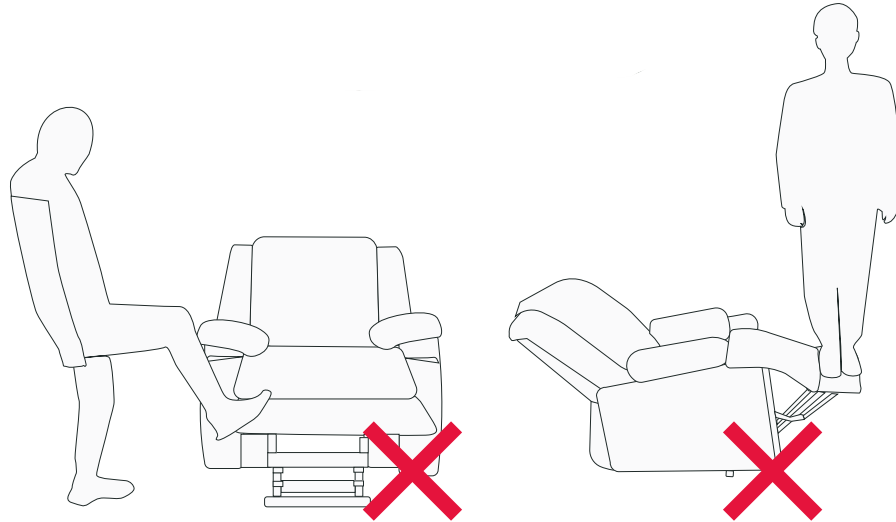

Leave enough space between chair back and wall before reclining

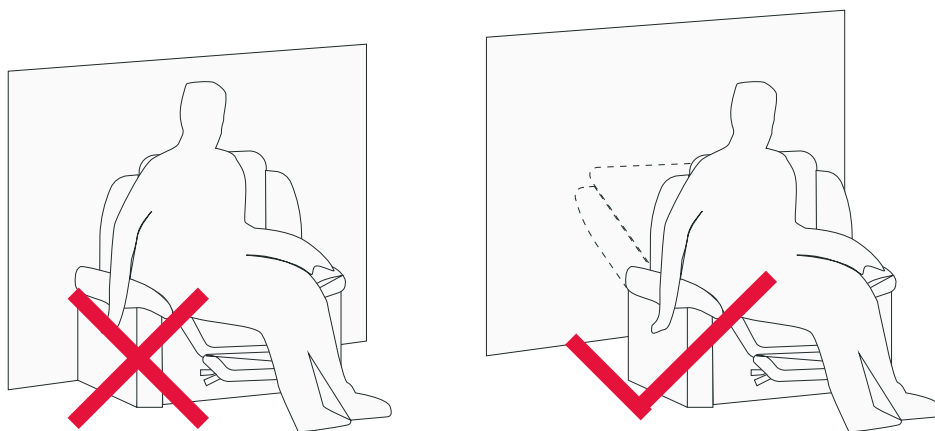

Leave enough space between chair back and wall before recline

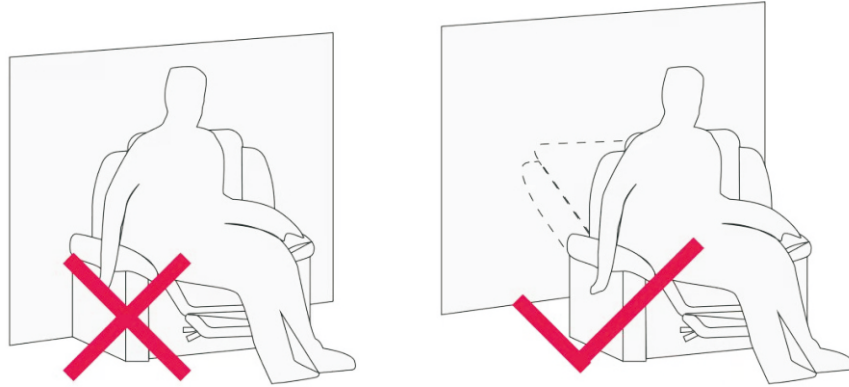

2-Person lift

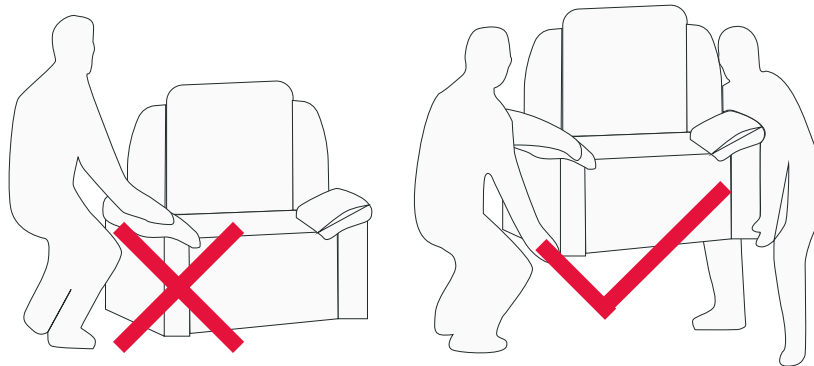

Do not move chair when it's reclining

