

# Assembly Instructions

**Caution : You must read this before you proceed**

**Please look underneath the table top for hardware packs.**

## **TABLE**





**CAUTION:** This Table is NOT a TOY.

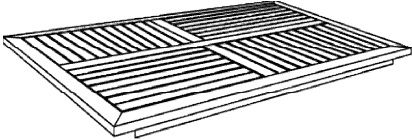

Keep your child / children at bay during the assembly process.

For moving the Table and to prevent damage to the Table, two adults are needed to execute this action.

# Parts List

Label	Picture	Description	QTY
A		Table Top	1
B		Leg	4
C		Leg Support	4

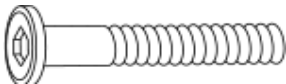
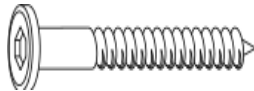
# Hardware

Label	Picture	Description	QTY
①		Bolt (M6x50mm)	9
②		Screw (M6x35mm)	9
③		Washer	9
④		Allen Key	1

# Assembly Preparation

Before Beginning Assembly:

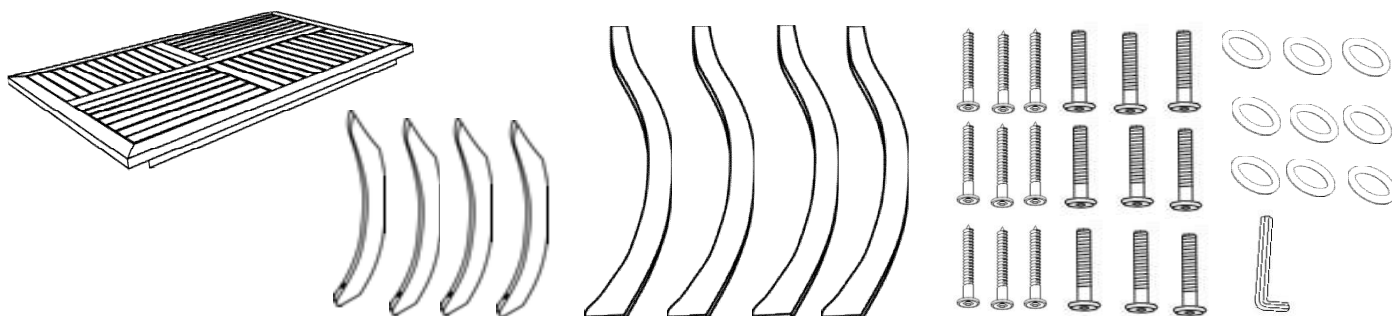

- Read instructions, cover to cover-



- Have 2 adults on hand for assembly-



- Do not assemble on flooring or carpet-



- Assemble on a clean non-marring surface (packing foam)-



- Save all packaging until finished-

# Assembly Steps

## OVERVIEW

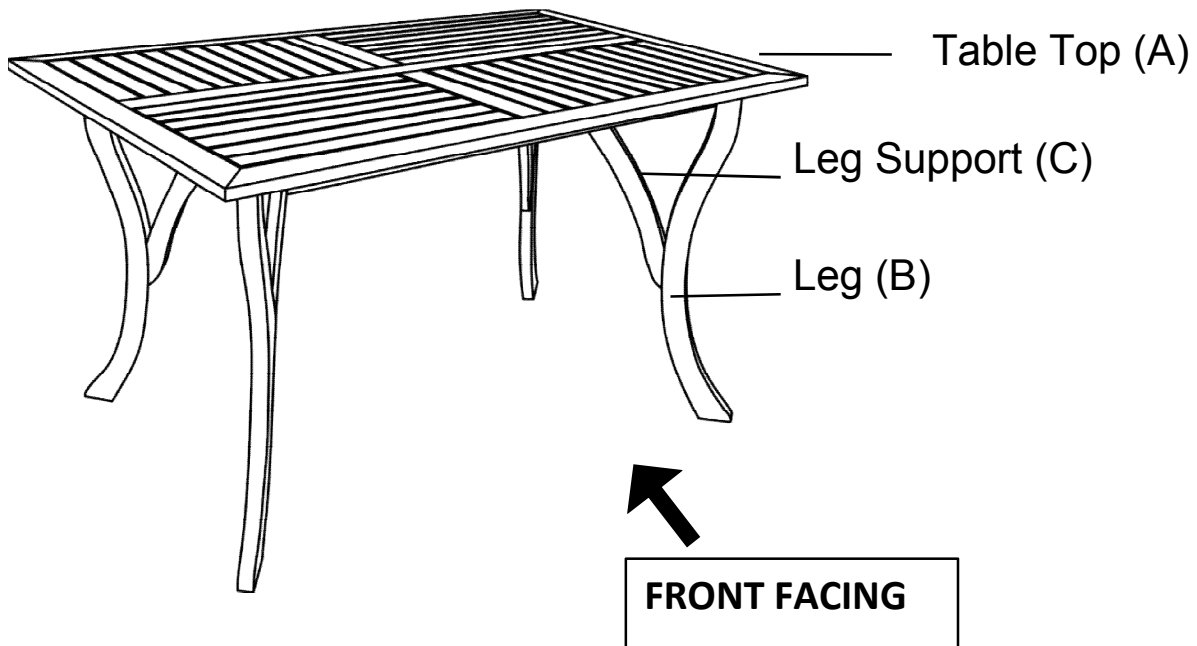

This Table has multiple parts and may require up to 30 minutes to assemble. To give you an overview of the Table parts, the above picture is to help you put the various parts into perspective. Please read through the instructions below to familiarise yourself with the parts and steps before assembly.

## Step 1

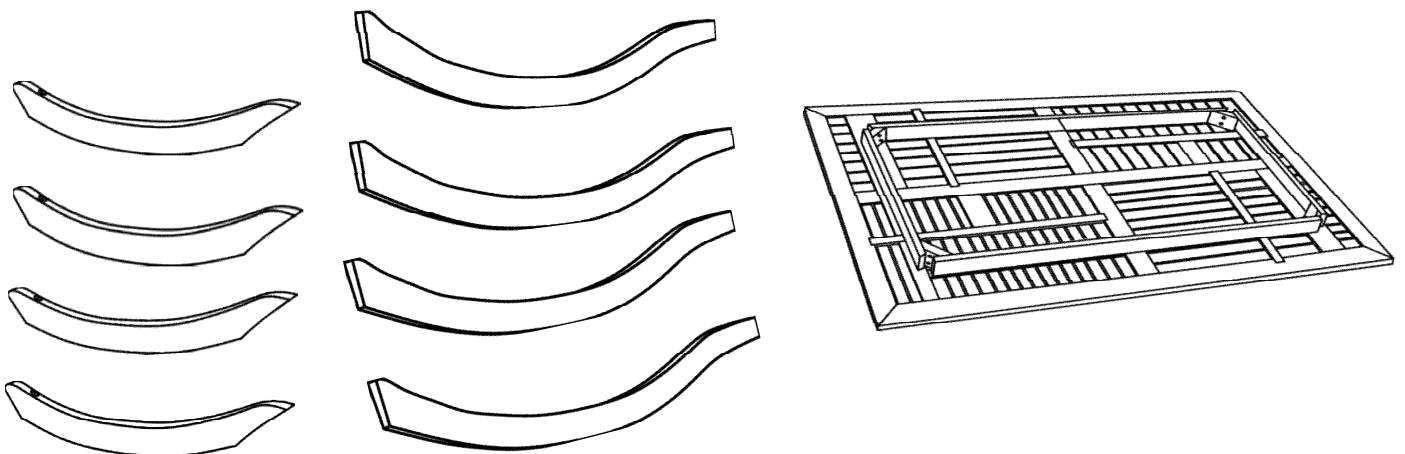

Unpack and place all parts on a clean, non-marring surface.

## Step 2

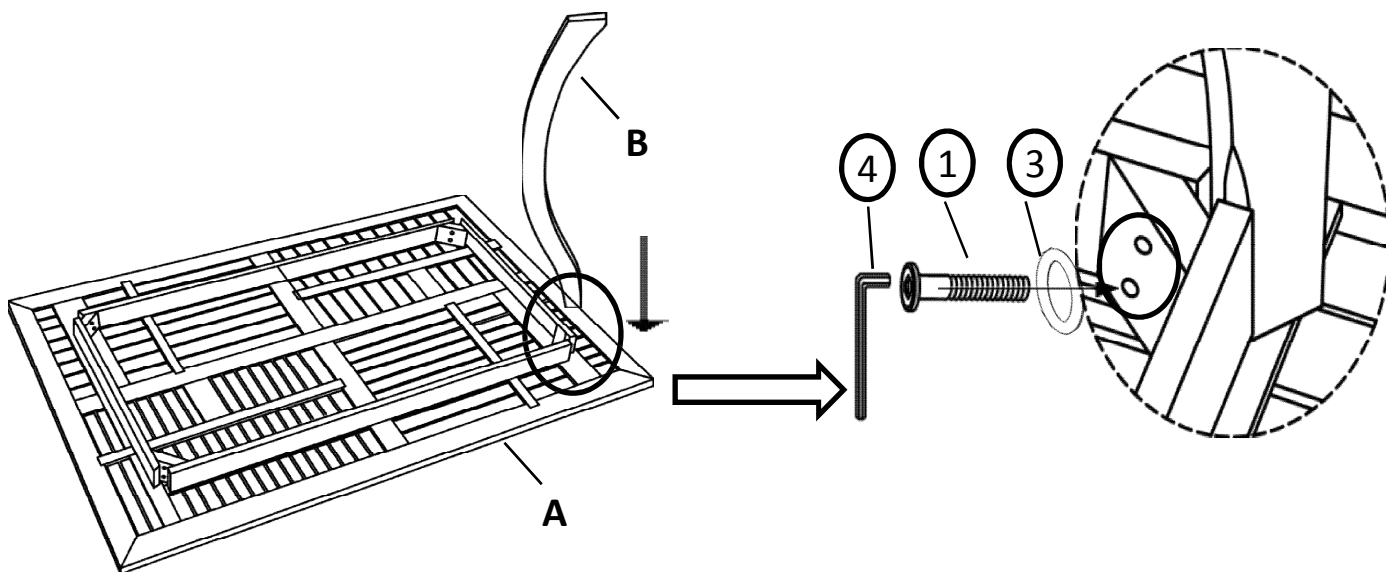

Attach Leg(B) to the Table Top(A) using Bolt(①) and Washer(③) with Allen Key(④).

**Do not fully tighten Bolts**

Repeat the same process with the remaining three Legs(B)

## Step 3

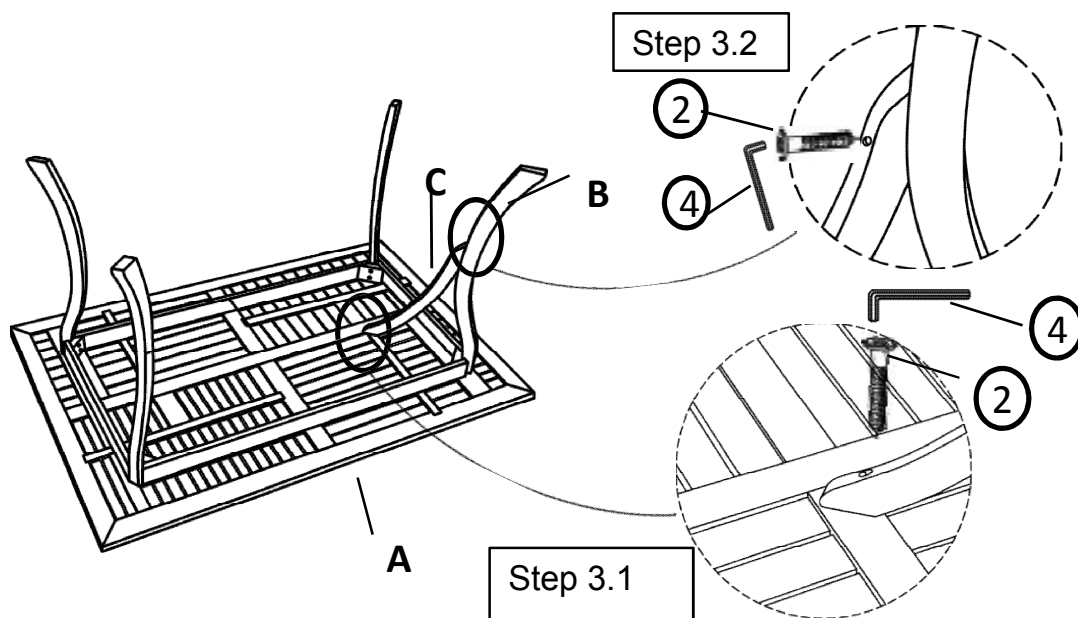

Place Leg Support(C) between Table Top(A) and Leg(B), as shown above.

**3.1** Secure Leg Support(C) to Table Top(A) using Screw(②) with Allen Key(④)

**3.2** Secure Leg Support(C) to Leg(B) using Screw(②) with Allen Key(④)

**Do not fully tighten Screws**

Repeat the same process with the remaining three Leg Supports(C).

## **Step 4**



Turn the Table over, with assistance from your partner.

EXERT pressure, floorwards, onto the Table.

This pressure will help the Legs and Table Top reach alignment at all joints.  
Check for wobbles.

In a sequential manner, gradually tighten all Bolts and Screws until evenly secured.

**When tightening the Bolts and Screws tighten sequentially.**

**Do not tighten any Bolt or Screw fully and then move towards the next one.  
This could cause the frame to warp.**

**If there are still wobbles, loosen the Bolts and Screws and execute the same above process.**

**If the Table is not Stable it could lead to damage to the product.**

## **Step 5**

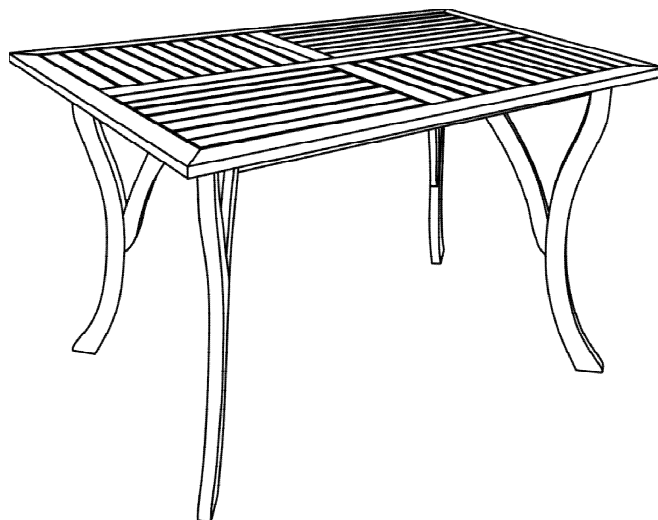









Inspect Table and make sure all parts are adequately connected.

Your Table is ready for use.

**This Table can only be used on a flat, level surface.**

## Care & Maintenance

- ⊘  ● Do not put hot items directly on furniture surface
  - ⊘  ● Do not clean furniture with harsh cleansers or polish.
  - ✓  ● To obtain the longest lifespan of your outdoor products, minimizing exposure to direct sunlight is recommended.
  - ⊘  ● Children should not climb or jump on the furniture.
  - ⊘  ● Do not write on furniture without a padded barrier to protect the surface.
  - ✓  ● To obtain the longest lifespan of your outdoor products, avoid extended and lengthy exposure to rain, snow, and direct sunshine. Whenever possible cover the product and /or place under patio or awnings.
  - ⊘  ● Not for commercial use. For residential use only .
  - ⊘  ● Stains may be removed with mild soap solution and damp cloth.
- 
- ✓  ● Dust and pick-up spills using a clean, non-colored, lint-free cloth .