

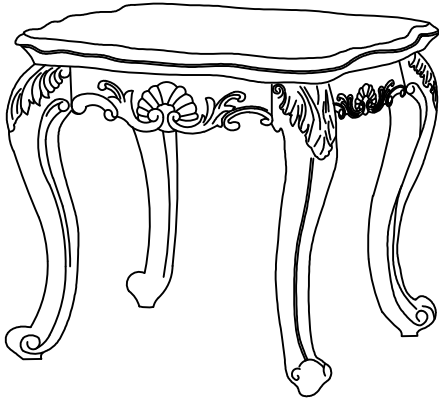



ASSEMBLY INSTRUCTIONS

END TABLE

Thank you for purchasing this quality product. Be sure to check all packing materials carefully for small parts, which may have come loose inside the carton during shipment. Identify and count all parts and compare with the parts list below.



HARDWARE LIST :

A		$\phi 5/16" \times 23$	8PCS
B		$\phi 5/16"$	8PCS
C		$\phi 5/16" \times 2"$	8PCS
D		12mm	1PC

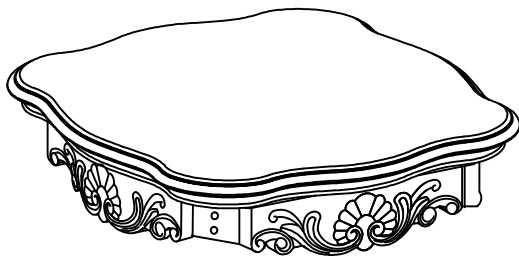
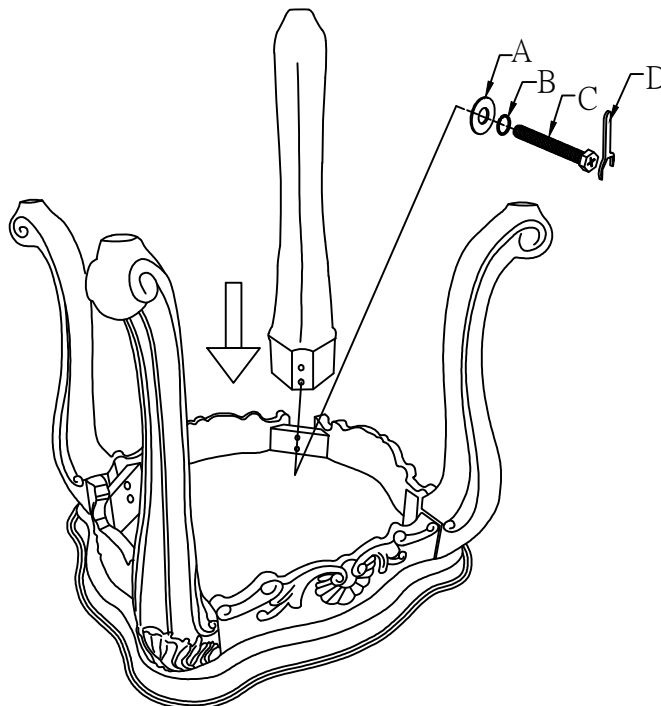

TABLE TOP 1PC



LEG 4PCS



Clean the surface with a furniture polish and a soft cloth