

NOTICE

- * Please make sure that you have all parts indicated and they are in good condition before you begin assembly of this item. Refer to part list and hardware list below for guidance.
- * This item should be assembled on a soft surface to prevent scratching the finish during assembly.
- * This item may require periodic tightening.
- * If you are having difficulty, our friendly Customer Care team is always here to help. Please Email customersupport@safavieh.com

PREPARATION

- * Before beginning assembly of product, make sure all parts are present. Compare parts with part contents list and hardware contents list.
- * If any part is missing or damaged, do not attempt to assemble the product.
- * Estimated Assembly Time: 10 minutes.
- * Tools Required for Assembly (included): Allen key.

CARE AND MAINTENANCE

WOOD CARE: Adhesive felt pads should always be applied to areas of furniture which make direct contact with flooring, said application will prevent damage to the furniture and or surfaces on which the furniture lies. Objects placed on articles of furniture should rest on nonabrasive material as to prevent damage to the wood finish. Wipe up spills immediately and avoid common hazards such as hot dishes, harsh solvents and abrasives. Cleaning should be done with a soft lint free cotton cloth dampened with water or furniture polish.



ITEM ID#: ACC9201

ITEM DIMENSION: 20.08"W x 20.08"D x 20.08"H

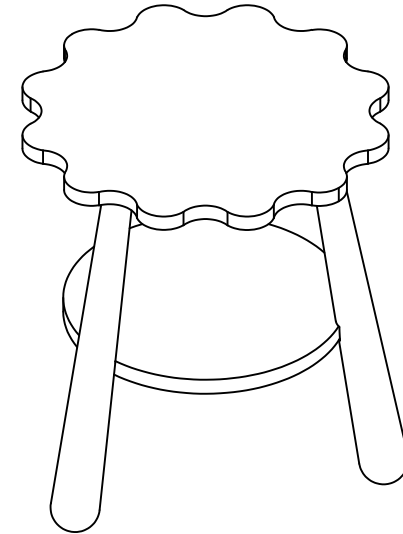





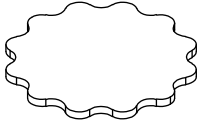
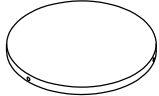
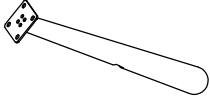

Weight capacity: 20 lbs

WARNING: DO NOT STAND ON TABLE

WARNING: DO NOT OVER TORQUE BOLTS

Part List and Hardware List

PIECE	DESCRIPTION	PICTURE	QUANTITY
A	TABLE TOP		1X
B	SHELF		1X
C	LEGS		3X

PIECE	DESCRIPTION	PICTURE	QUANTITY
HW1	BOLT: 6*20mm		12X
HW2	SPRING WASHER: 6*10mm		12X
HW3	FLAT WASHER: 6*14mm		12X
HW4	SEMICIRCLE WASHER		3X
HW5	BOLT: 6*40mm		3X
HW6	ALLEN KEY		1X

PREPARATION

- * Before beginning assembly of product, make sure all parts are present. Compare parts with part contents list and hardware contents list.
- * If any part is missing or damaged, do not attempt to assemble the product.
- * Estimated Assembly Time: 10 minutes.
- * Tools Required for Assembly (included): Allen key.
- * If you are having difficulty, our friendly Customer Care team is always here to help. Please email customersupport@safavieh.com

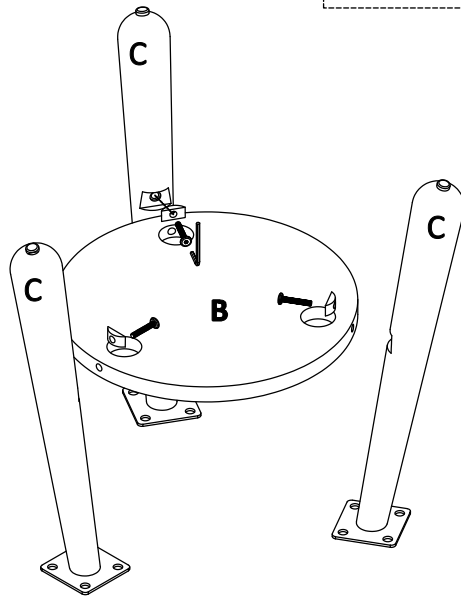
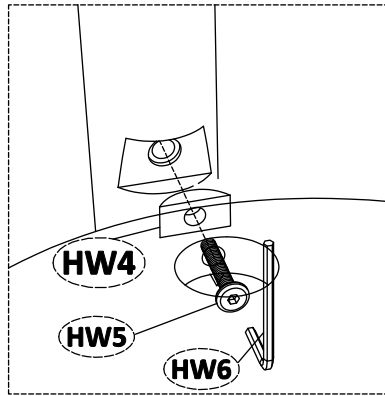

Step 1: Place the Semicircle Washer (HW4) on the Bolt (HW5). Attach the Shelf (B) to the Legs (C) by using the Allen Key (HW6) to screw in the Bolt (HW5) with the washer.

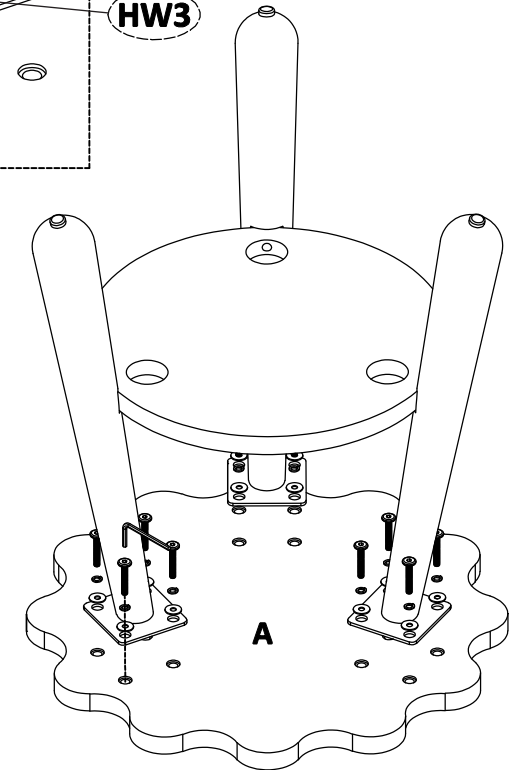
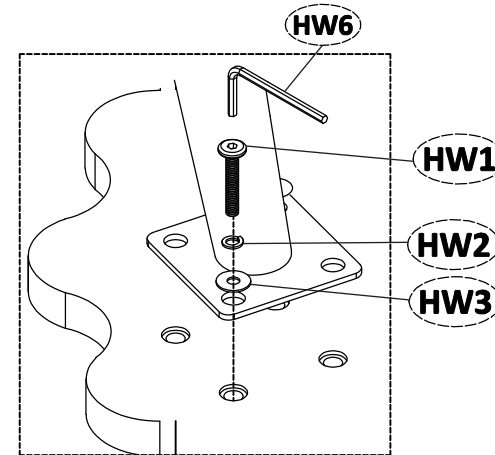

Step 2: Place the Spring Washer (HW2) and the Flat Washer (HW3) on the Bolt (HW1). Attach the Legs (C) to the Table Top (A) by using the Allen Key (HW6) to screw in the Bolt (HW1) with the washers as shown.