

## WARNING

- \* Switch off the main electrical supply from the main fuse box / circuit breaker before installation.
- \* Inspect item carefully before attempting to install.
- \* If there is any damages or obvious defects, do not install.
- \* Item may not be returned once it has been installed.

## CARE AND MAINTENANCE

- \* To clean the outside of the fixture, use a dry or slightly dampened clean cloth (use clean water, never a solvent) to wipe the surface of the fixture.
- \* To clean the inside of the fixture, first disconnect power to the fixture by turning off the circuit breaker or by removing the fuse at the fuse box. Next, use a dry or slightly dampened clean cloth (use clean water, never a solvent) to wipe the interior surface of the fixture.
- \* Do not use any cleaners with chemical, solvents or harsh abrasives. Use only a dry soft cloth to dust or wipe carefully.

## NOTICE& IMPORTANT SAFETY INSTRUCTIONS







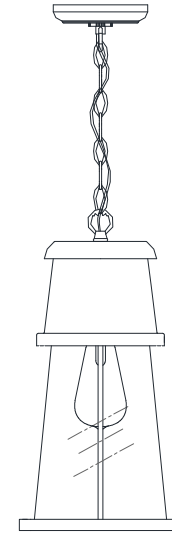





- \* Please make sure that you have all parts indicated before you begin assembly of this item
- \* This item should be assembled on a soft surface to prevent scratching the finish during assembly
- \* To reduce the risk of fire, electrical shock or injury to persons or property, please follow the guideline below for safe use and installation
- \*The external flexible cable or cord of this luminaire cannot be replaced  
If the cord is damaged, the luminaire shall be destroyed

# Owner Manual

Product Dimensions: 8.375"D X 21.5-93.5"H



### Part List and Hardware List

PIECE	DESCRIPTION	PICTURE	QUANTITY	PIECE	DESCRIPTION	PICTURE	QUANTITY	PIECE	DESCRIPTION	PICTURE	QUANTITY
A	Mounting plate		1X	F	canopy nut		1X	J	Socket ring		1X
B	wire nut		3X	G	chain		1X	K	bulb		1X
C	machine screw		2X	G1	closable link		2X	L	lamp body		1X
D	canopy		1X	H	fixture loop		1X				
E	hanging loop		1X	I	Glass shade		1X				

## PREPARATION

- \* Before beginning assembly of product, make sure all parts are present. Compare parts with package contents list and hardware contents list.
- \* If any part is missing or damaged, do not attempt to assemble the product.
- \* Estimated Assembly Time: 20 minutes.
- \* Tools Required for Assembly (not included): Screwdriver, Junction box
- \* If you are having difficulty, our friendly Customer Care team is always here to help.

**NOTE: PLEASE USE TYPE "A" BULB MAX 60-WATT OR LED BULB MAX 9-WATT, THERE ARE 1PCS LED 4-WATT BULB IN THE BOX**

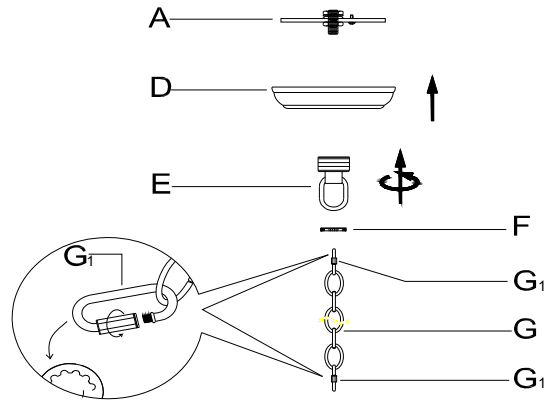

### Step 1:

Unpack all parts from cartons carefully. Place the Mounting Plate(A) onto the Hanging Loop(E) through the Canopy(D) and fix it by turning the Canopy Nut(F) clockwise till tight.

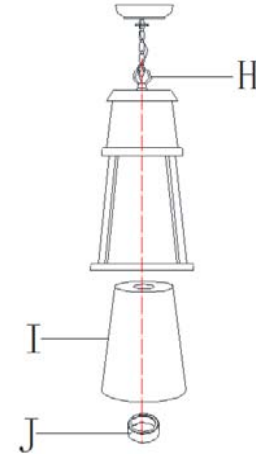

### Step 2:

Put the glass shade(I) on the Socket and fasten the Socket ring(J) to fix it. Place the Fixture loop(H) onto the Lamp body(L). Attach the Closable Link(G1) onto the Fixture Loop(H)

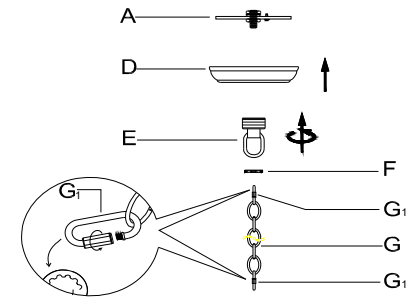

### Step 3:

Make wire connections, with wire nut(B)  
 Connect fixture neutral wire (ribbed) to the outlet box neutral wire (usually white) using a wire nut. Connect fixture hot wire (smooth with markings) to the outlet box hot wire (usually black) using a wire nut.

CAUTION: Do not reverse the hot and neutral connections

Grounding Instructions:

Wrap ground wire from outlet box around green ground screw(Q) on mounting bracket, no less than 2" from wire end. Tighten ground screw. If fixture is supplied with a ground wire, connect to outlet ground wire with a wire nut.

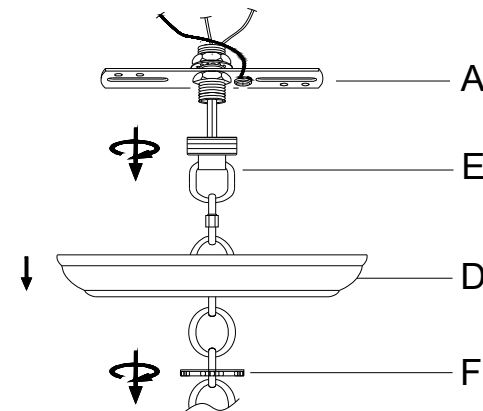

### Step 4:

Separate the Mounting Plate(A) from the Canopy(D) by turning the Canopy Nut(F) anti-clockwise.

## PREPARATION

- \* Before beginning assembly of product, make sure all parts are present. Compare parts with package contents list and hardware contents list.
- \* If any part is missing or damaged, do not attempt to assemble the product.
- \* Estimated Assembly Time: 20 minutes.
- \* Tools Required for Assembly (not included): Screwdriver, Junction box
- \* If you are having difficulty, our friendly Customer Care team is always here to help.

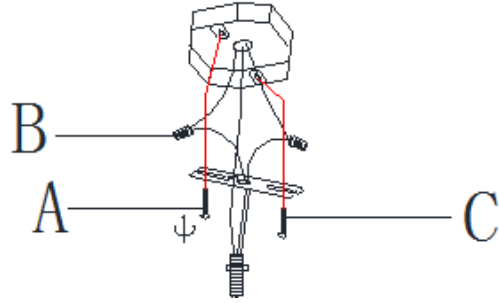

### Step 5:

Install the Mounting Plate(A) to the junction box with machine Screw (C)

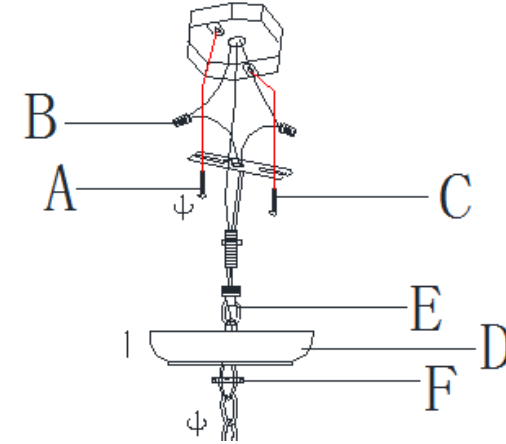

### Step 6:

Attach the Canopy(D) to the junction box and fix it by turning the Canopy Nut(F) clockwise

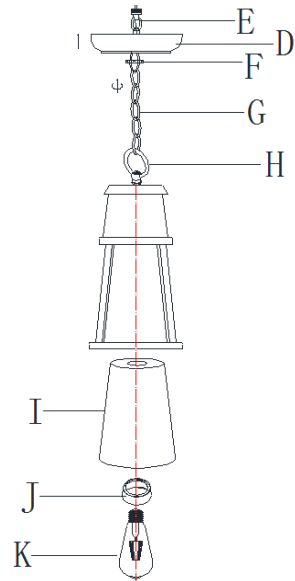

### Step 7:

Insert the bulbs (K) into the Sockets