

# Assembly Instructions

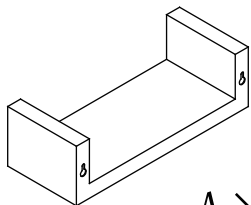

A × 3

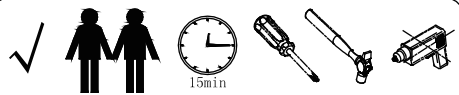
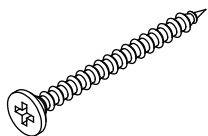

b × 6

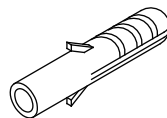

c × 6

① × 3

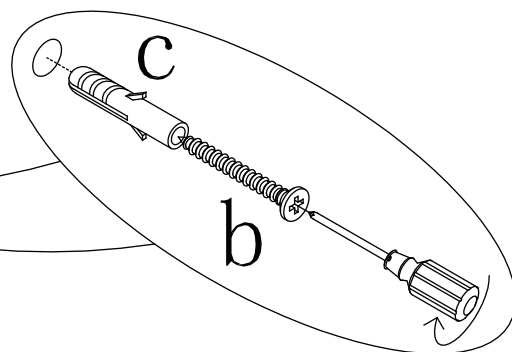
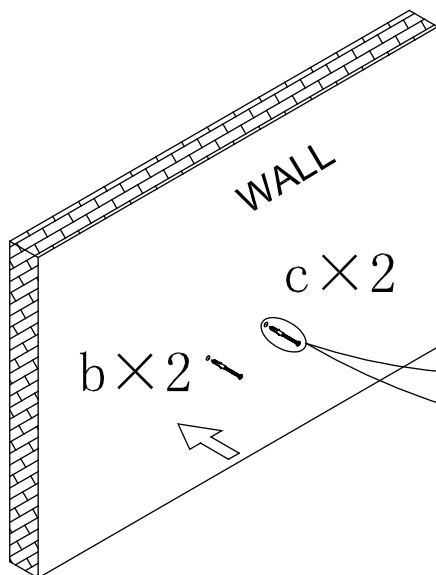

② × 3

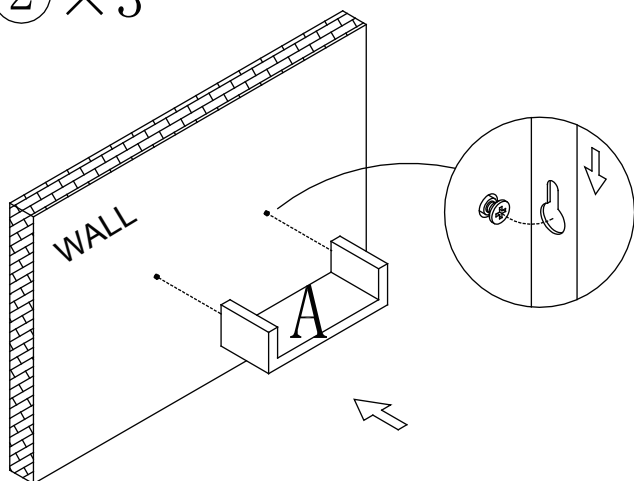

③

