

# ASSEMBLY INSTRUCTIONS

---

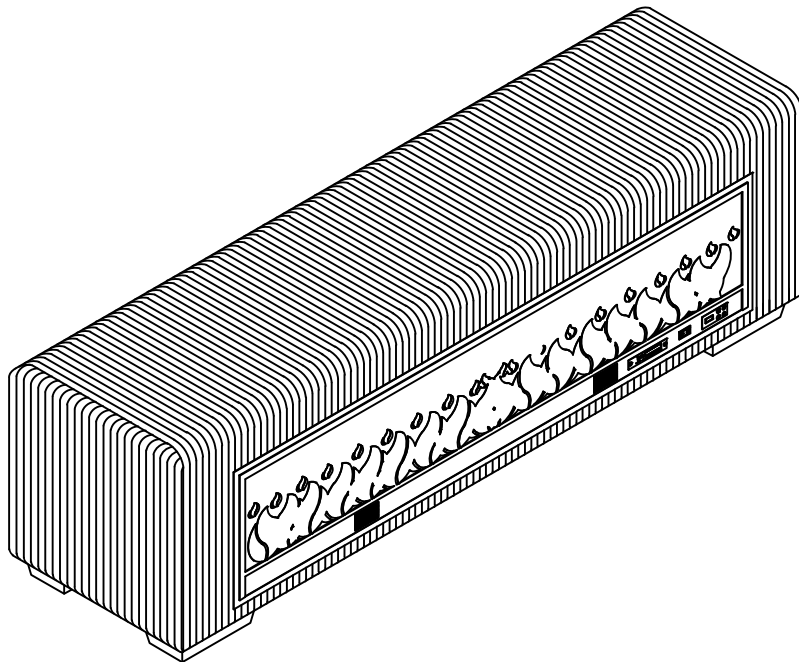

## TOOLS REQUIRED



Screwdriver  
(Not Included)



(Included)  
Allen Wrench

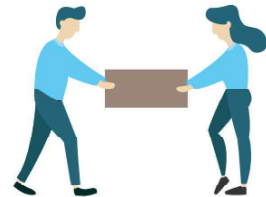

2 - People

## ASSEMBLY RATING



EASY ————— DIFFICULT

The Assembly Rating is a 5-point system showing the level of effort needed to assemble a specific product.



## **CHECK BEFORE STARTING**

### **Are you missing anything?**

Double-check all parts, hardware and accessories listed are all accounted for.

### **Check out our Quick Tips!**

We recommend reviewing the pre-assembly handouts. Even experts need a refresher now and then!

### **Should we send any replacements?**

Are there any irregularities or flaws in the parts? We can send replacements!

### **Prep Time!**

Please review the assembly instructions and all diagrams prior to assembling.

# PRE ASSEMBLY INTRODUCTION

We understand building ready-to-assemble furniture can be a challenging experience for some. To help avoid confusion, we have provided some helpful tips that may speed up the process.



## Teamwork

ALWAYS have at least two people to help with transporting and assembling the product to avoid potential injury and/or damage.

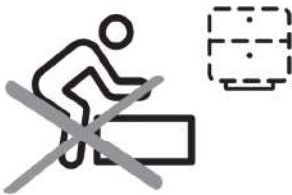

## Suitable Location

Assembling near the area of the intended location is highly recommended.



## Sufficient Space

Make sure you have enough space to move around during the assembly.



## Avoid Scratches

Use cardboard, blankets or a carpeted area while assembling furniture to prevent scratches and damages.

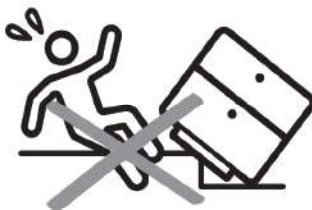

## Flat Surface

Make sure the furniture rests on a flat and level surface with each leg evenly touching the floor.

# ASSEMBLY AND CARE ADVICE



**FAILURE TO FOLLOW THE GUIDELINES BELOW MAY RESULT IN INJURY AND/OR PROPERTY DAMAGE.**



Position each part correctly and insert screws or bolts into their respective holes.

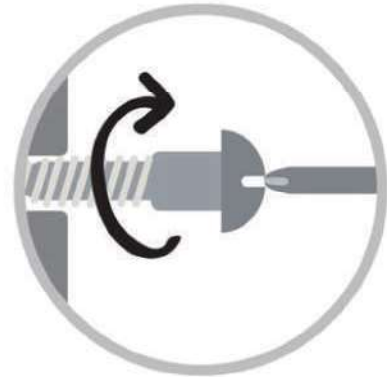

Turn clockwise to tighten and only tighten when step is completed or when instructed to do so.



Use the appropriate hand tools or power tools for assembly. Select steps, such as tightening screws and/or bolts, may require hand tools to avoid causing damage during assembly.



Save the instructions and store any supplied tools for later maintenance.

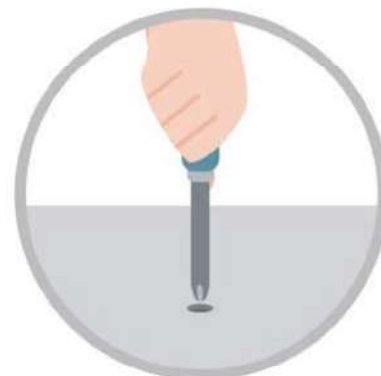

After two weeks, check and tighten any loose hardware and repeat again every six months thereafter.

**IT IS THE USER'S RESPONSIBILITY TO MAINTAIN THE FURNITURE. THE HARDWARE MAY LOOSEN OVER TIME AND MAY CAUSE THE FURNITURE TO BE WOBBLY AND UNABLE TO SUPPORT ITS INTENDED WEIGHT CAPACITY. THIS MAY LEAD TO COLLAPSE AND MAY CAUSE SERIOUS INJURY.**

# SAFETY INFORMATION (CONTINUED)

## FCC STATEMENT

**Note:** This equipment has been tested and found to comply with the limits for a Class B digital device, pursuant to Part 15 of the FCC Rules.

These limits are designed to provide reasonable protection against harmful interference in a residential installation. This equipment generates, uses, and can radiate radio frequency energy and, if not installed and used in accordance with the instructions, may cause harmful interference to radio communications. However, there is no guarantee that interference will not occur in a particular installation. If this equipment does cause harmful interference to radio or television reception, which can be determined by turning the equipment off and on, the user is encouraged to try to correct the interference by one or more of the following measures:

- Reorient or relocate the receiving antenna.
- Increase the separation between the equipment and the receiver.
- Connect the equipment into an outlet on a circuit different from that to which the receiver is connected.
- Consult the dealer or an experienced radio/TV technician for help.

This device complies with Part 15 of the FCC Rules. Operation is subject to the following two conditions:

1) This device may not cause harmful interference, and

2) This device must accept any interference received, including interference that may cause undesired operation.

**CAUTION:** Changes or modifications not expressly approved by the party responsible for compliance could void user's authority to operate the equipment.

# BENCH



- Please keep instructions for future reference.
- Check the quantity and irregularity of parts and hardware before you start.

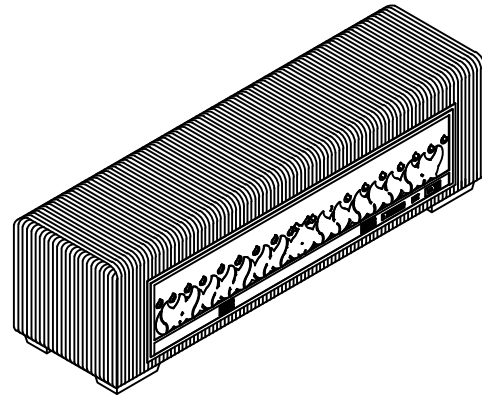

## PARTS

1

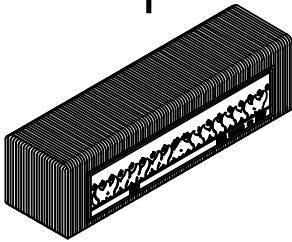

**Bench**  
1pc

2

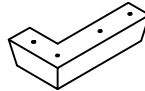

**Left Legs**  
2pcs

3

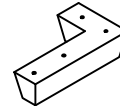

**Right Legs**  
2pcs

4



**Remode Control**  
1pc

## HARDWARE PART

A

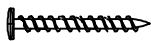

**Screw #8x50mm**  
16pcs

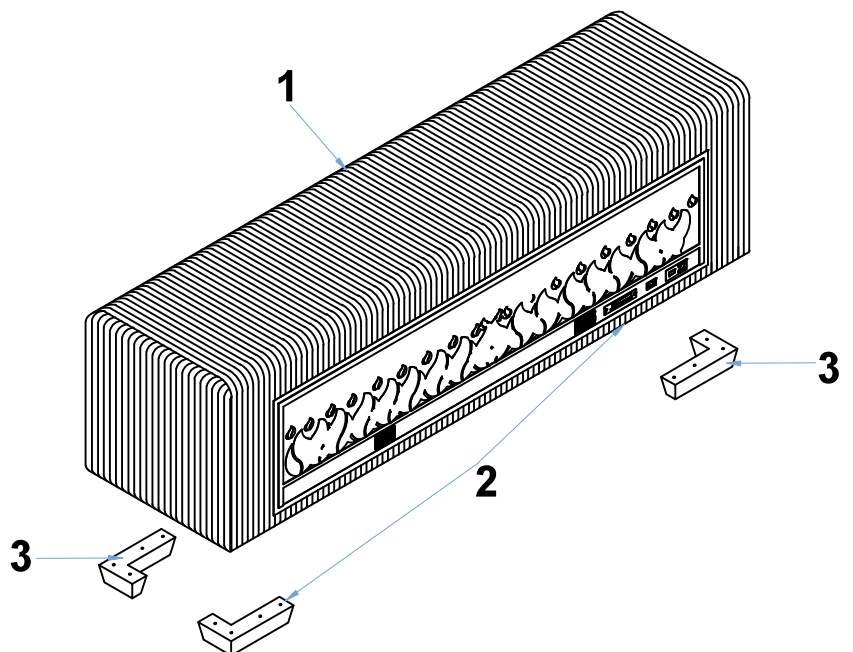

# ASSEMBLY INSTRUCTIONS

1

- Part 1 x1pc
- Part 2 x2pcs
- Part 3 x2pcs
- Hardware A x16pcs

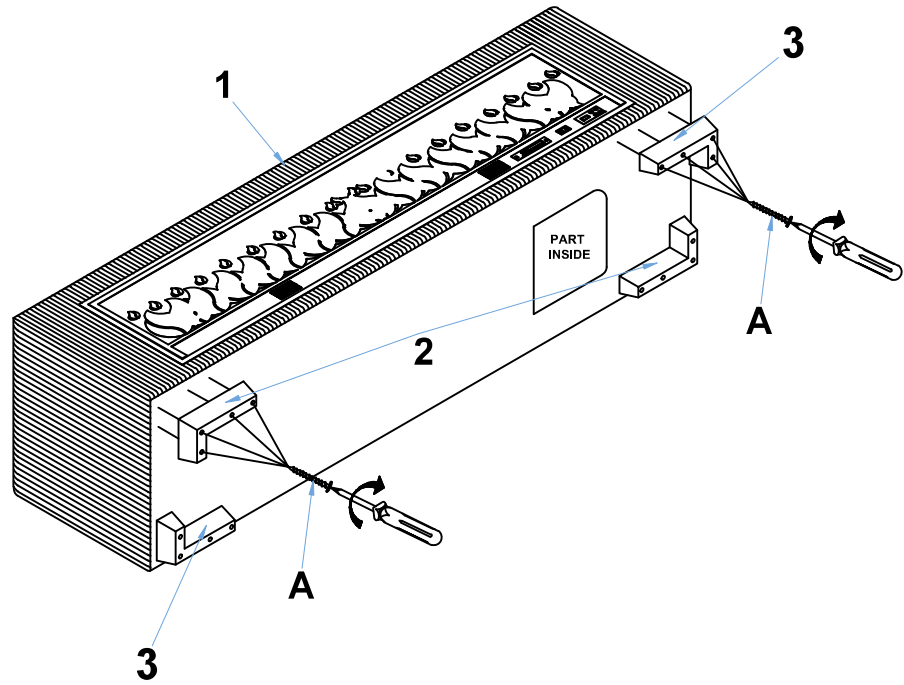

2

- Part 1 x1pc

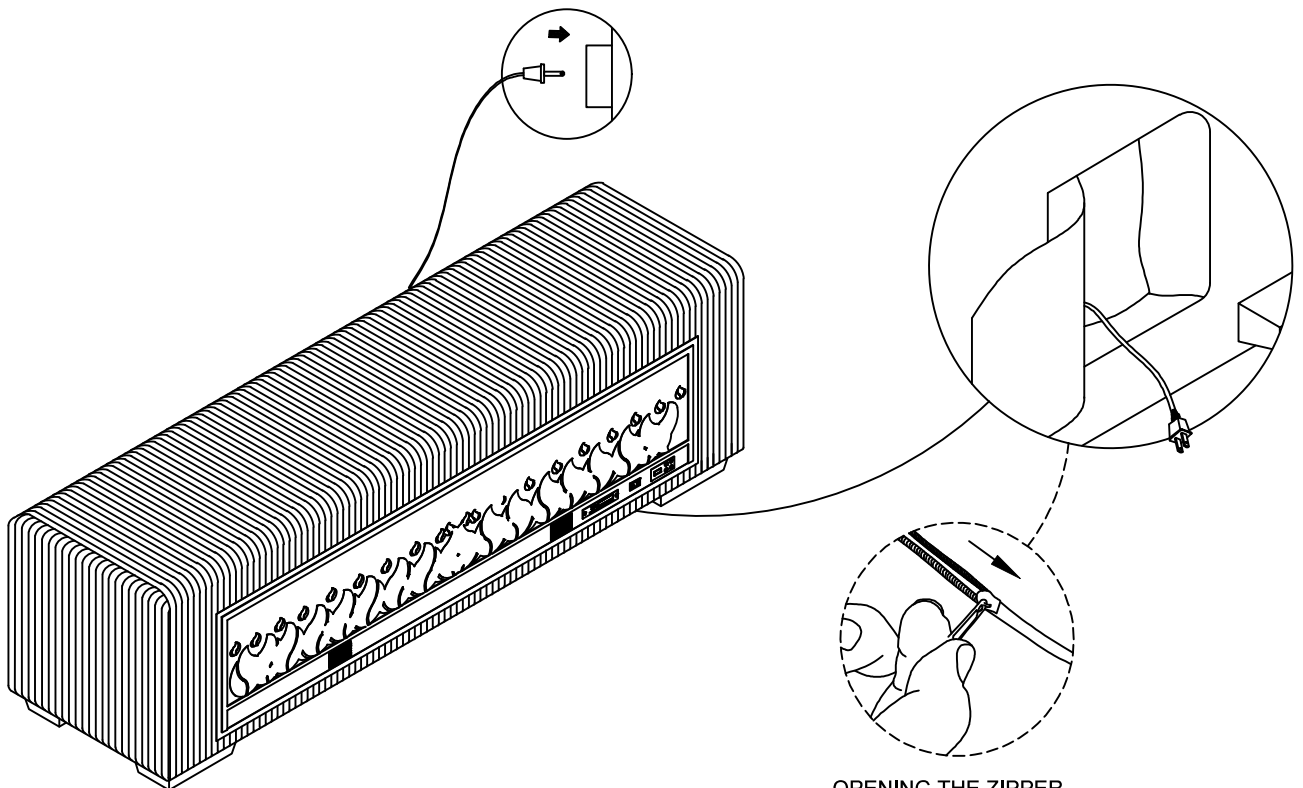

OPENING THE ZIPPER  
HERE FOR ASSEMBLY.

# ASSEMBLY INSTRUCTIONS

3

Part 4 x1pc

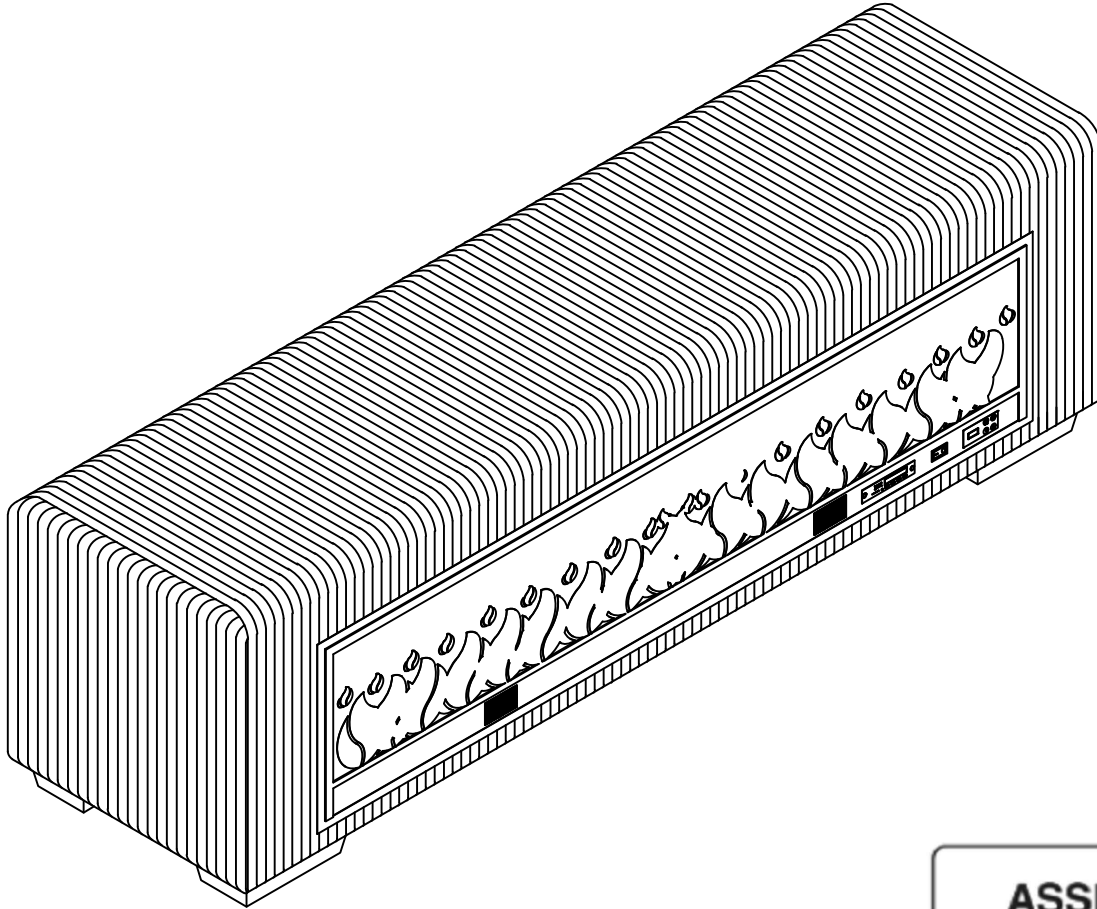

Bluetooth RS01

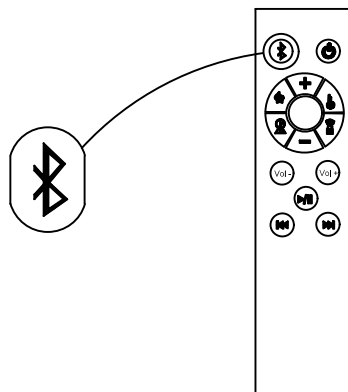

4- REMOTE CONTROL

## ASSEMBLY COMPLETED



Please ensure the furniture rests on an even and flat surface. If the product wobbles or feels loose, double-check all bolts and/or screws are properly tightened and secured.



### Keep this handy!

Please retain this instruction manual and any order-related information for future reference.



### Lift, don't drag!

To avoid damage to product please always LIFT the product when transporting or adjusting the placement.

This product is intended for RESIDENTIAL USE ONLY and not for commercial use.

# USER INSTRUCTIONS

## Bluetooth Speaker Instruction

### CONTROL PANEL MENU:

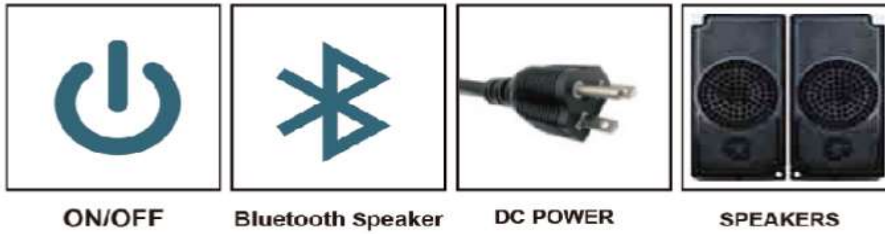

### INSTRUCTION STEPS AS FOLLOVED:

- 1 Connect the DC power adapter to wall socket
- 2 Turn the switch ON
- 3 Enable the bluetooth function in your digital device
- 4 Search for bluetooth speaker name "RS01"
- 5 Pair with the bluetooth speaker name "RS01"
- 6 Start playing your audio

To use the Auxiliary function, switch from Off to On.  
Connect the Auxiliary Audio cable to the input on your furniture.  
Once the connections are secure, start playing.

### Flame Simulator Keypad Function Instructions:

## HERE ARE TWO WAYS TO OPERATE THE ELECTRIC :

\* **Keyboard operation of electric .**

\* **Remote control operation.**



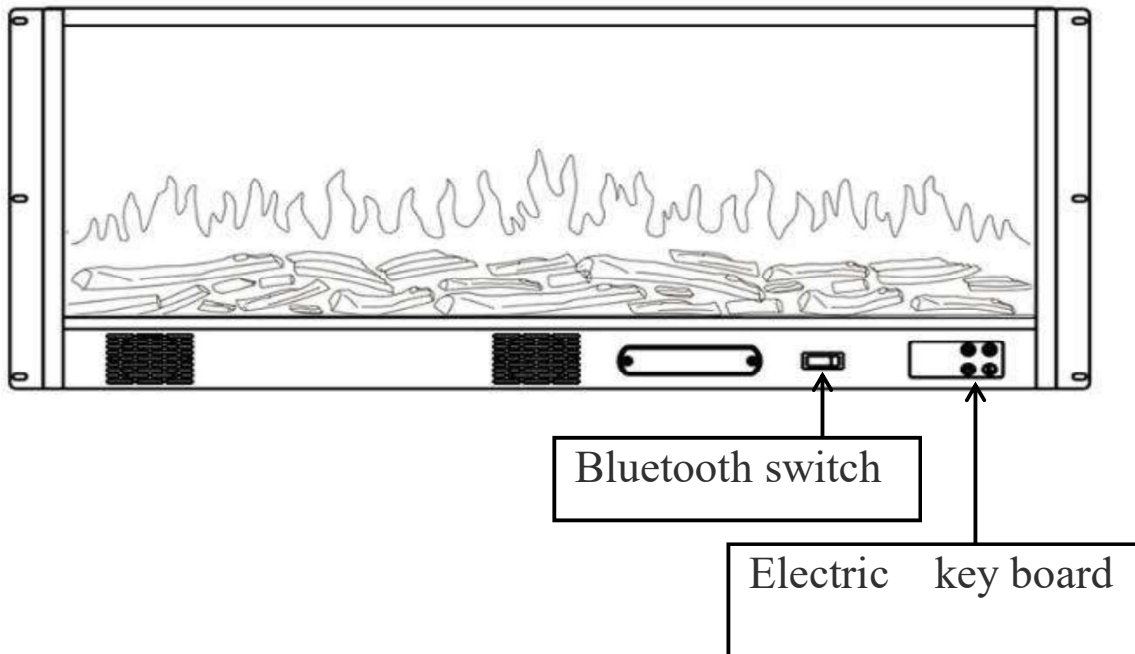

The keypad is on the upper right of the electric . (See Figure 1)

Figure 1

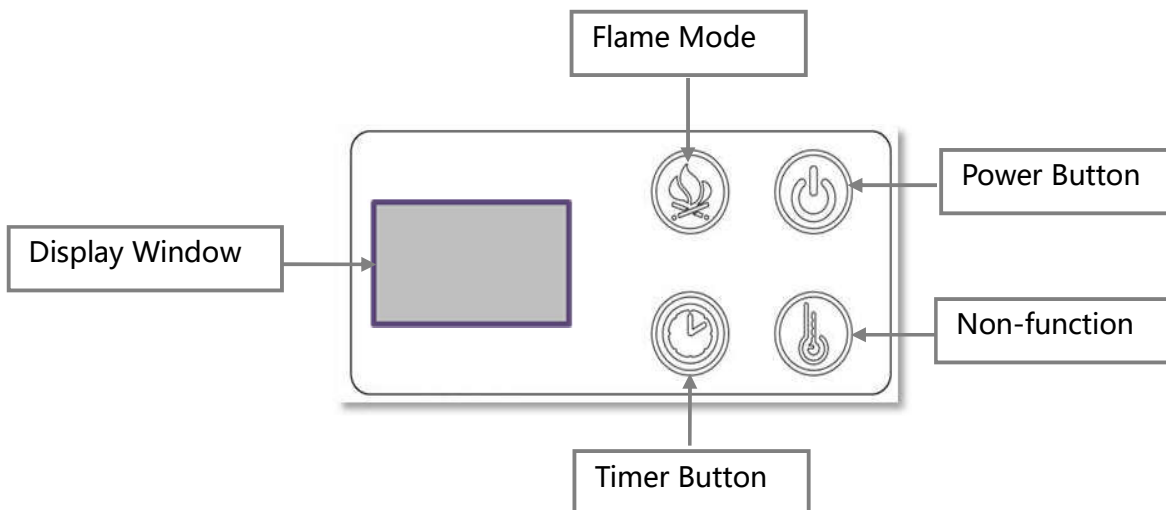

**\*Keyboard operation of the electric .**



BUTTON	Operation	Function
 <b>Power</b>	When the Power is turned on, the display shows the ambient temperature and the flame is turned on.	
 <b>Flame</b>	Short press the flame button to turn on the flame color change or mode;	Color change : There are C1-C7 color changes,
 <b>Heate</b>	non-function	non-function
 <b>Timer</b>	Long press the timer to turn it on or off the timer function, the default is 1H (timer can reach 9H).	Press timer to select time 1H, 1H, 2H, 3H, 4H, 5H, 6H, 7H, 8H,9H; After 15 seconds of no operation, the setting will be automatically locked, the timer will be displayed, and the screen will be off after 5 seconds; When the timer ends, it will automatically shut down
 <b>Display Window</b>	Display the numbers flame, carbon bed, heating and timing	

## Remote control operation:

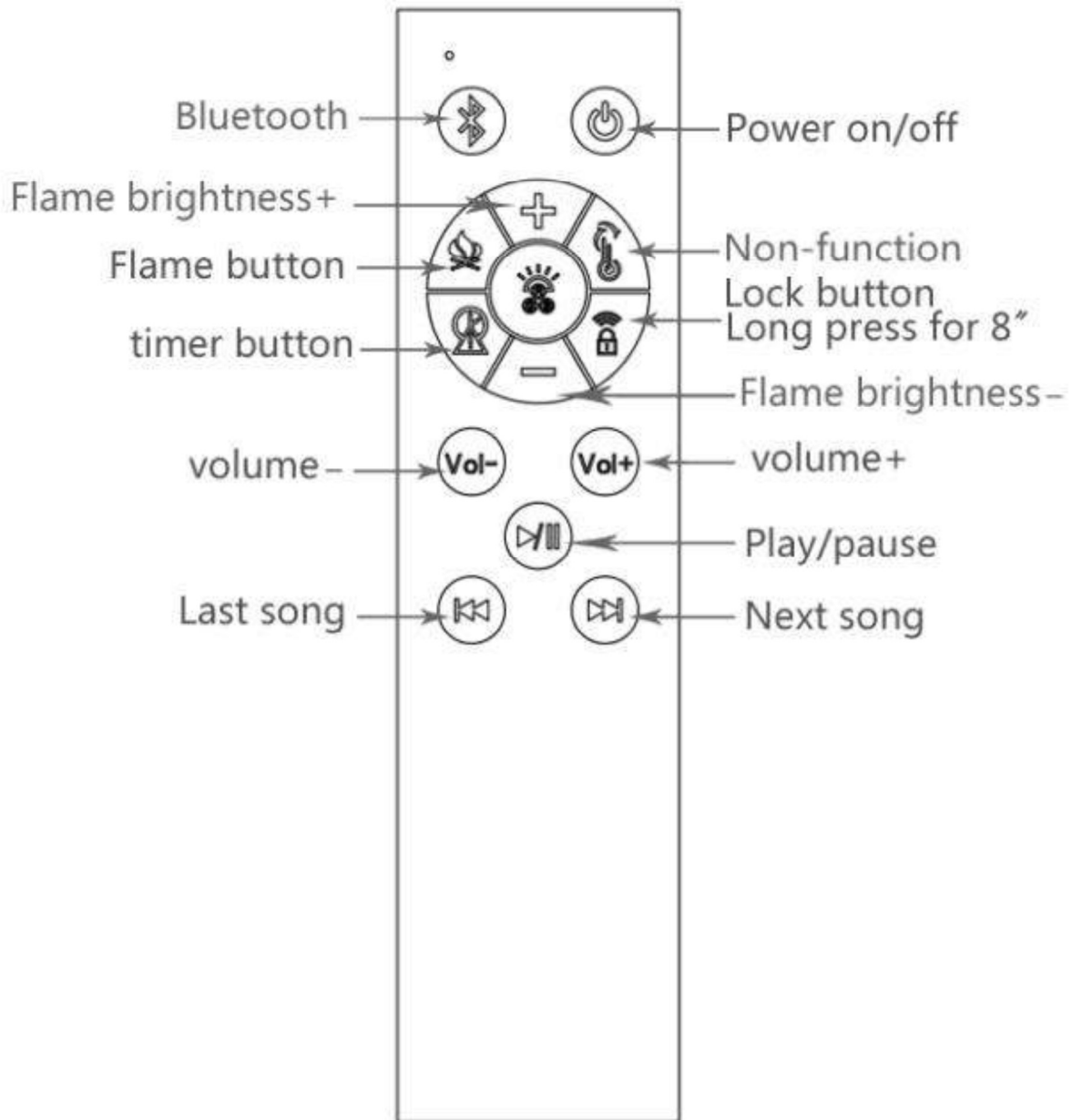

## Technical Specification

**Product name : Electric**

**Supply : 120V AC 60Hz**

**Rated power : 15W/M long**

## MAINTENANCE:

Clean the metal trim using a water-dampened soft, clean cloth. DO NOT use brass polish or household cleaners as these products will damage the metal trim.

**WARNING:** Any electrical repairs of this unit should be carried out by a licensed electrician in accordance with national and local codes.

**WARNING:** Disconnect power by unplugging the power before attempting any maintenance or cleaning to reduce the risk of fire, electric shock, or injury.

## REMOTE CONTROL:

The battery compartment is located on the back end of the remote control.

1. Press and slide the battery cover open.
2. Insert two 1.5V (AAA) batteries (included) ensuring they are installed correctly with regard to the polarities (+ and -) marked on the inside of the battery compartment.
3. Replace the battery cover.

NOTE: The battery should be removed if the product is to be left unused for a long time.

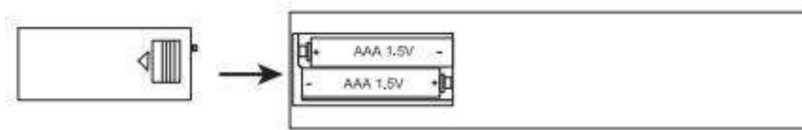

When replacing the batteries, replace both batteries at the same time with new batteries of the correct type.

- Do not mix old and new batteries.
- Do not mix alkaline, standard (Carbon-Zinc), or rechargeable (Nicad, Nimh, etc) batteries.

## Maintenance instructions:

1. Please cut off the power supply and let it cool before cleaning;
2. Avoid bumping or scratching the electric to avoid rust caused by surface coating damage;
3. The surface can be cleaned with a wet towel and no detergent can be used;
4. It is strictly prohibited to infiltrate water and water droplets into the machine to avoid damaging internal components and causing short circuit to damage the machine.

Troubleshooting list	
Fault phenomenon	Exclusion method
Nixie tube displays "E1"	The NTC is open circuit or the plug-in sensor is not connected. Open the inspection port of the main board and plug in the sensor again or replace it
The nixie tube displays "E2"	Replace the sensor