

# INSTRUCTION MANUAL

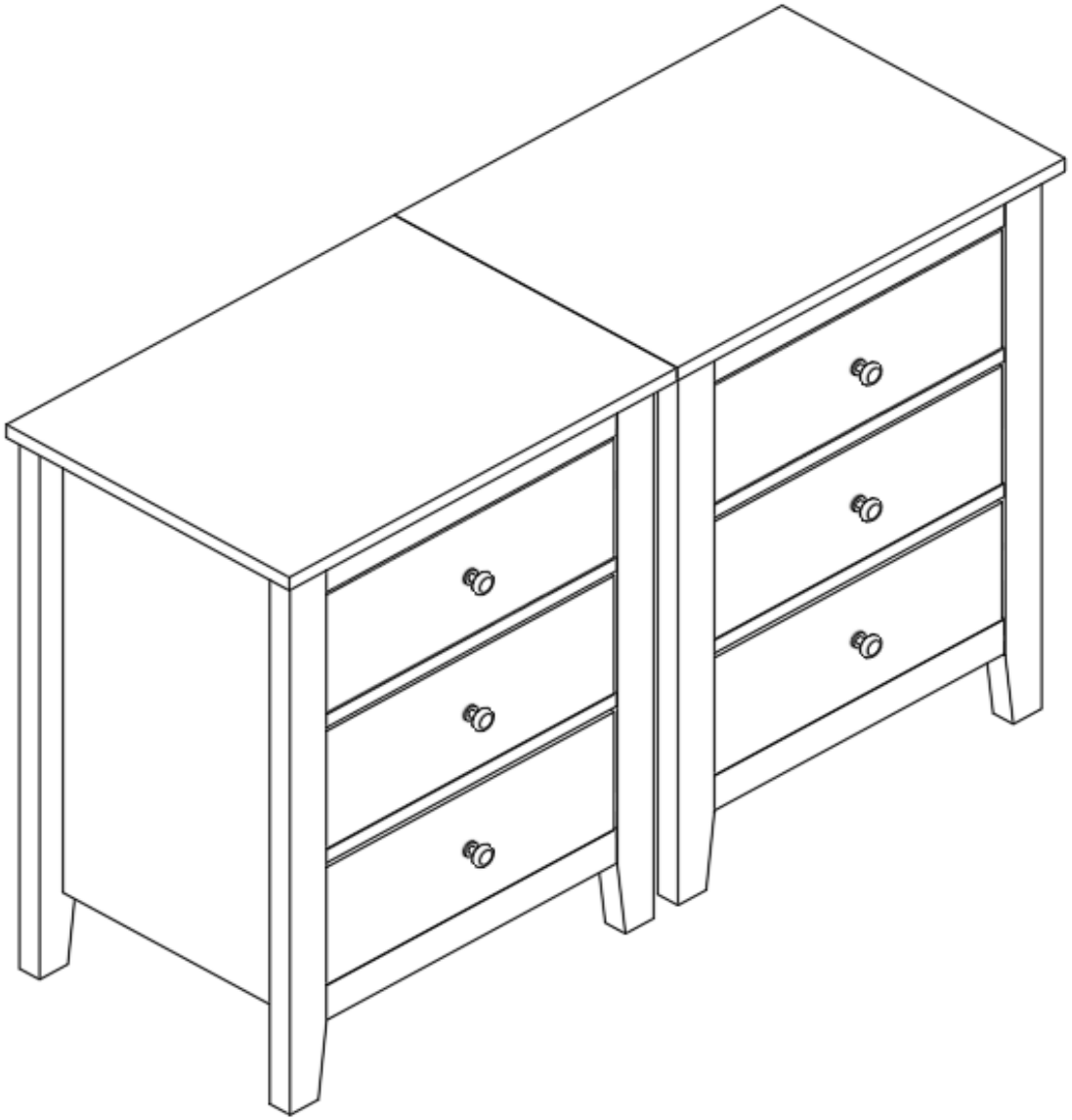

# Contact Information

Question about your product? We're here to help. Contact us by:



Orders FAQ



Product Assembly



Product Inquiry



Chat Support



Returns & Refunds

If you have any problems, please send your order number and photos to us. We will contact you within 24 hours and provide you with a satisfactory solution.

**! NOTICE** Please retain these instructions for future reference.

- Carefully unpack all the components and verify that all the necessary parts are included as listed in the packaging.
- Identify each component and refer to the provided assembly diagram or step-by-step instructions.
- Assemble the furniture in the order specified to ensure proper alignment and fit.
- Use the provided tools or recommended tools for assembly. Do not use excessive force when tightening screws or bolts.
- If any difficulties arise during assembly. Consult the troubleshooting section or contact our customer support.

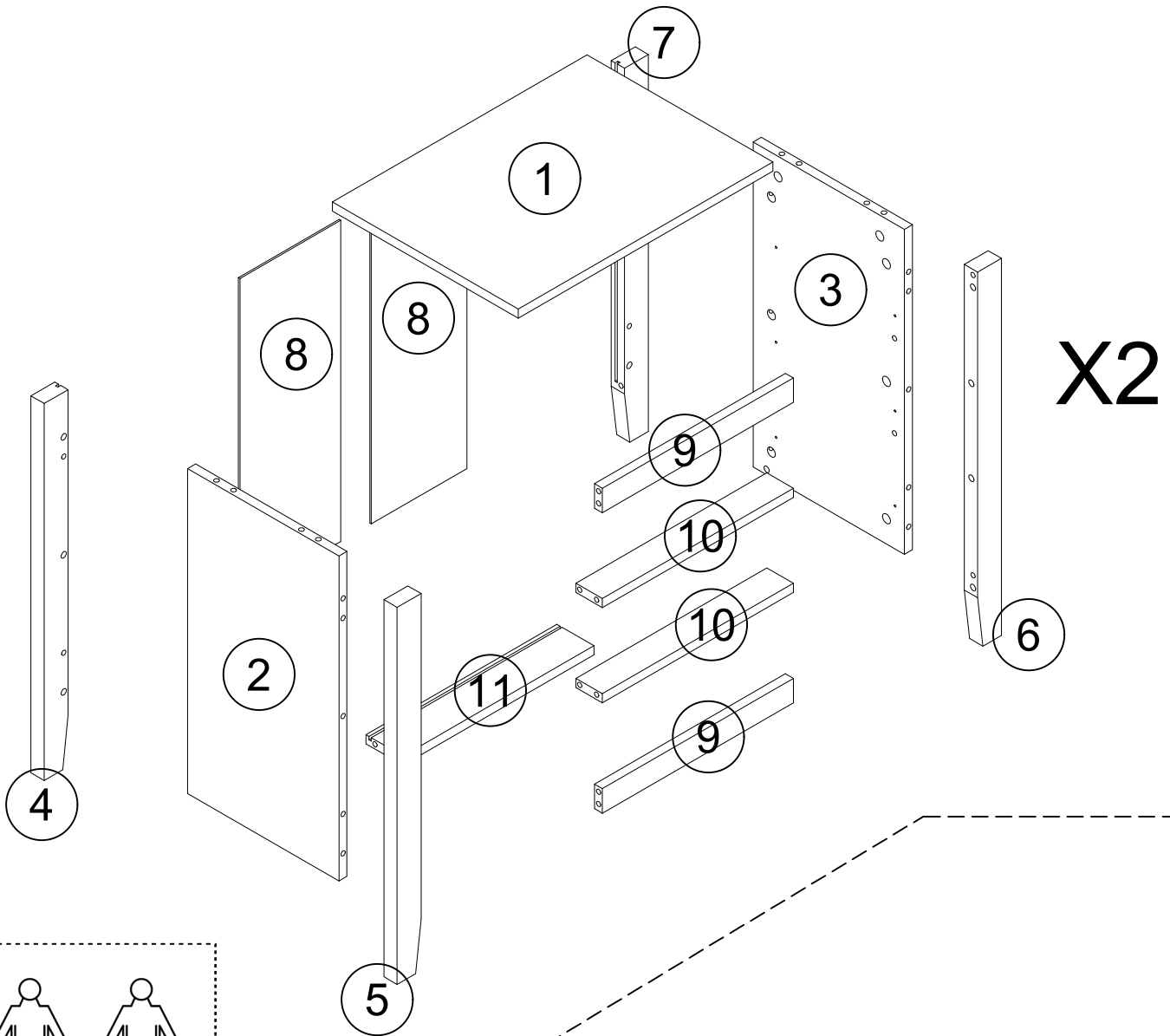

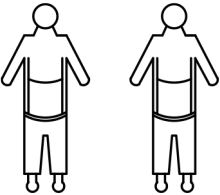
  
2 people

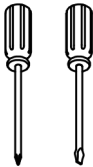

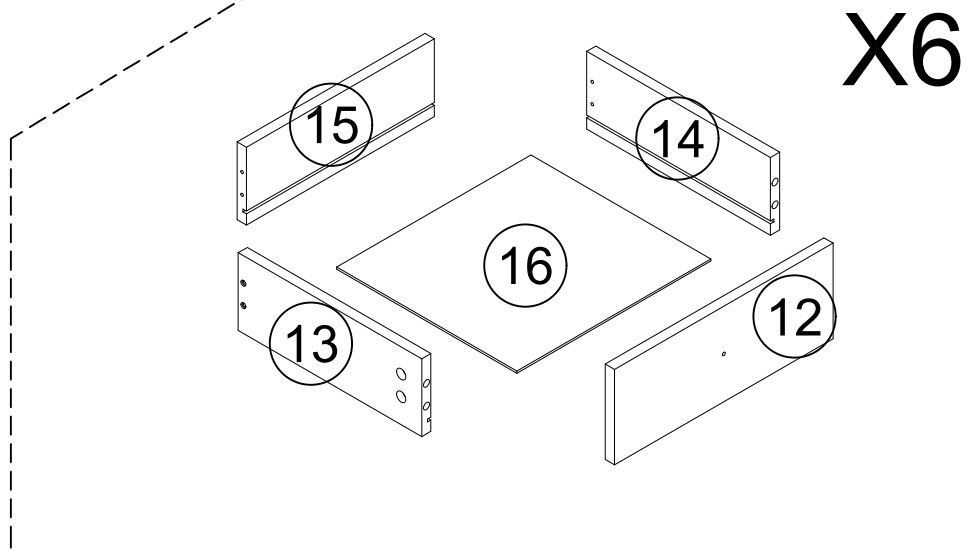



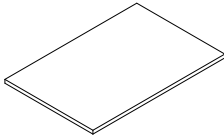
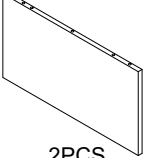
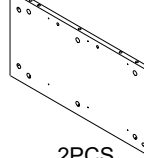
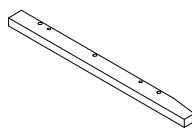
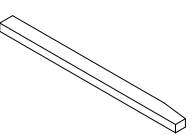
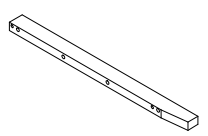
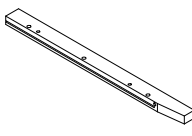
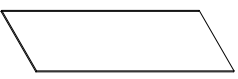
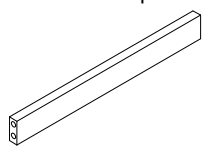
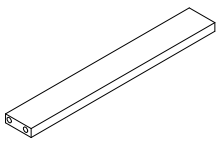
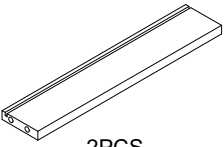
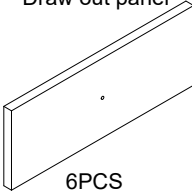
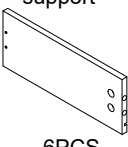
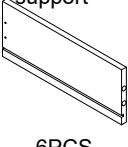
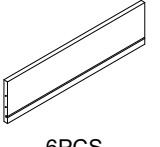
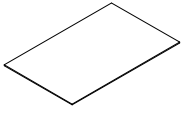





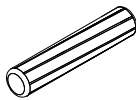
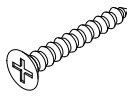

  
Phillips Screwdriver



# ☰ PARTS LIST

<b>1</b> Roof panel  2PCS	<b>2</b> Left panel  2PCS	<b>3</b> Right panel  2PCS	<b>4</b> Rear left leg  2PCS	<b>5</b> Left front leg  2PCS
<b>6</b> Rear right leg  2PCS	<b>7</b> Right front leg  2PCS	<b>8</b> Backplate  4PCS	<b>9</b> Front trim panel  4PCS	<b>10</b> Front pull strap  4PCS
<b>11</b> Rear lower rail  2PCS	<b>12</b> Draw out panel  6PCS	<b>13</b> Left side support  6PCS	<b>14</b> Right side support  6PCS	<b>15</b> Plug and block  6PCS
<b>16</b> Bottom drawer  6PCS				

# ☰ HARDWARE LIST

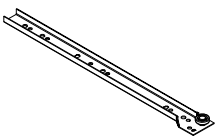
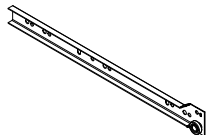
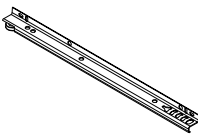
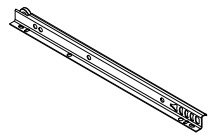
<b>A1</b> Ø6x40mm Cam Bolt  76+2PCS	<b>A2</b> Ø15x10mm Cam Lock  76+1PCSM	<b>B</b> Ø8x30mm Dowel  44+2PCS	<b>C</b> Ø3.5x35mm Screw  24+2PCS	<b>D</b> Ø3.5x14mm Screw  64+4PCS
<b>E1</b> Round Knob  6PCS	<b>E2</b> 4x18mm Handle Bolt  6PCS	<b>F1</b> Anti-slip metal strip  2PCS	<b>F2</b> Decorative cover  2PCS	<b>F3</b> Ø3.5x14mm Screw  2PCS
<b>F4</b> Ø3.5x35mm Screw  2PCS	<b>F5</b> Plastic Expansion  2PCS	<b>G</b> Back Buckle  16PCS	<b>H</b> 514mm H- shaped Rod  2PCS	<b>I</b> Cover Stickers  76PCS
<b>CL</b> Sliding Track  6PCS	<b>CR</b> Sliding Track  6PCS	<b>DL</b> Sliding Track  6PCS	<b>DR</b> Sliding Track  6PCS	



If you are missing any parts, please provide your order number and circle the part number. Send us a photo of this, and we will provide you with a satisfactory solution. Thank you.

# STEP1

Please tighten the screws after completing all installation.

Por favor, apriete los tornillos después de instalar todo.

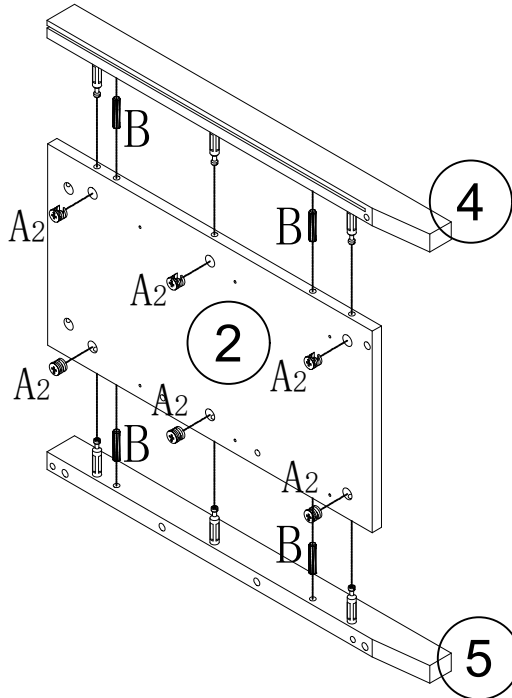
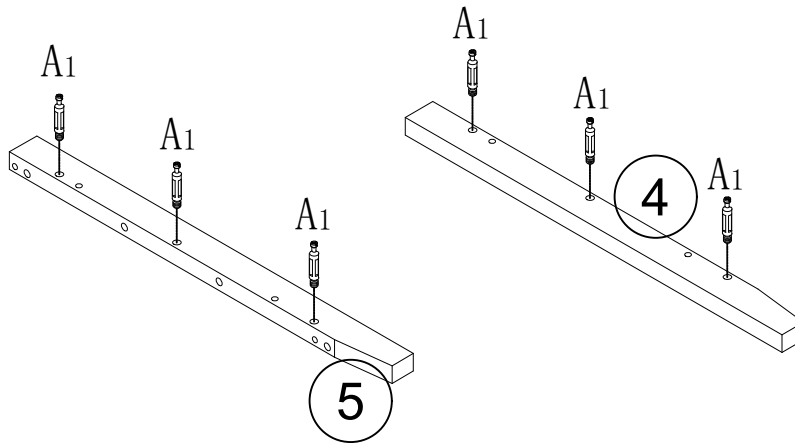
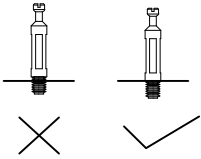
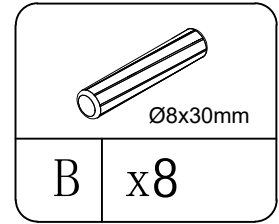
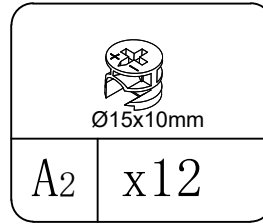
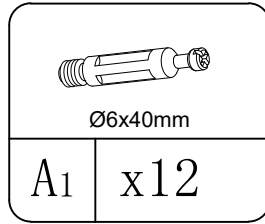
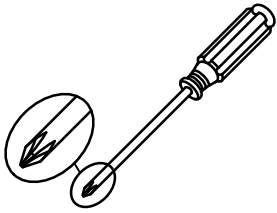

X2

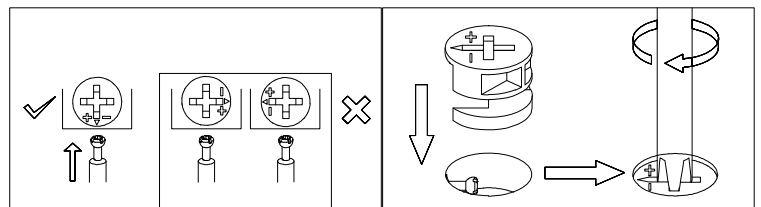

# STEP2

Please tighten the screws after completing all installation.

Por favor, apriete los tornillos después de instalar todo.

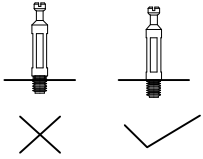
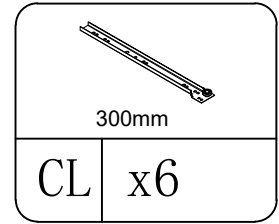
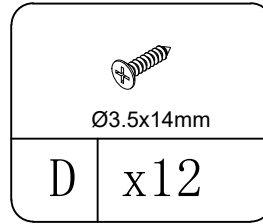
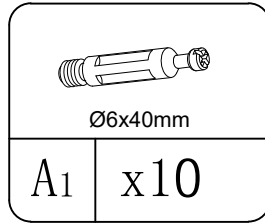
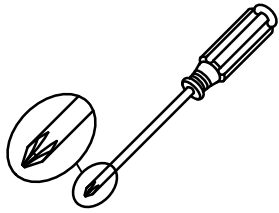

# X2

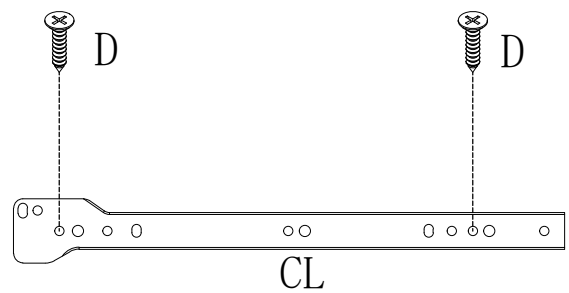
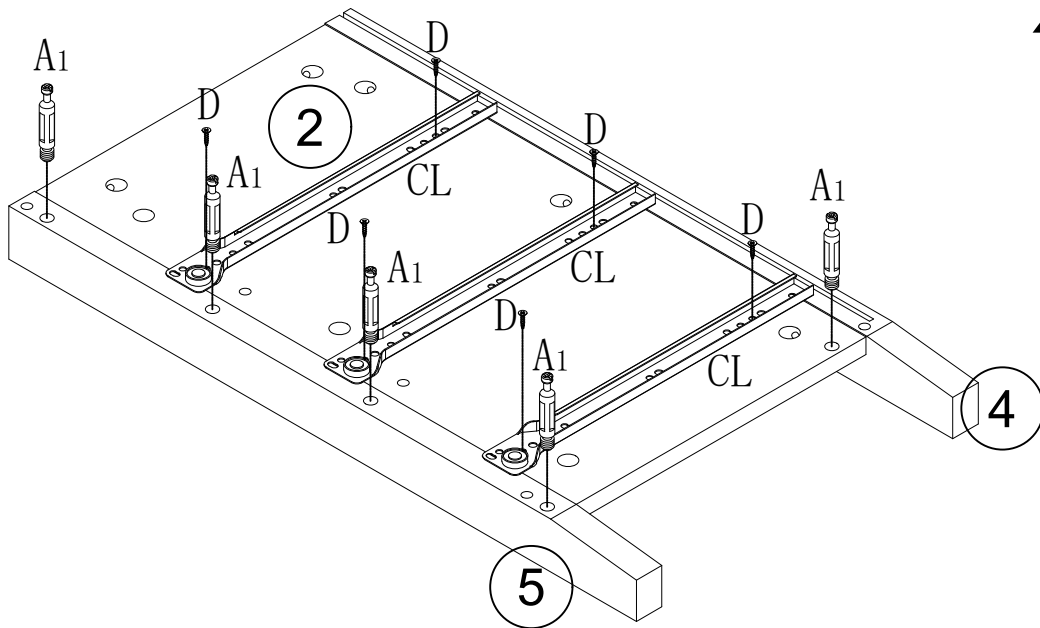

# STEP3

Please tighten the screws after completing all installation.

Por favor, apriete los tornillos después de instalar todo.

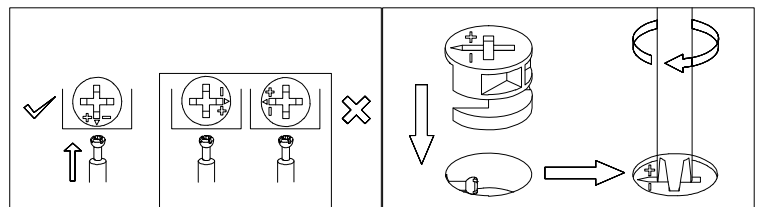
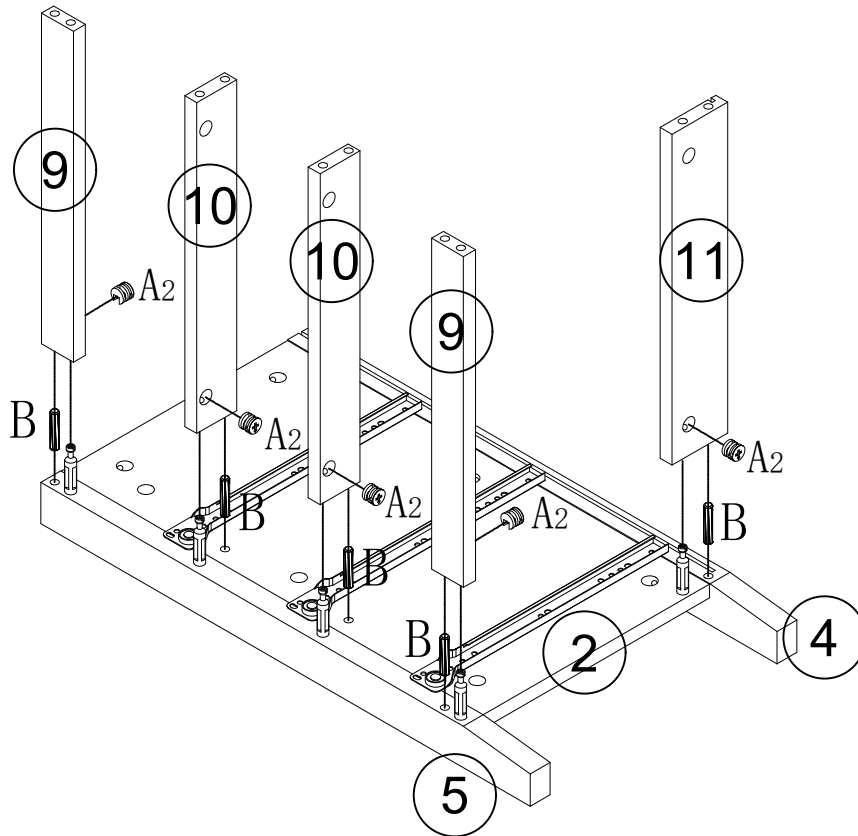
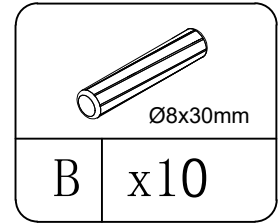
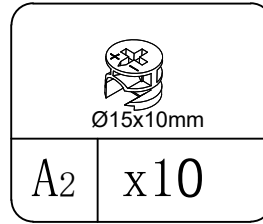
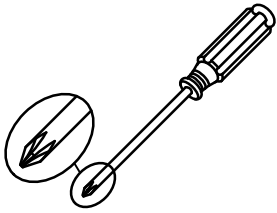

# STEP4

Please tighten the screws after completing all installation.

Por favor, apriete los tornillos después de instalar todo.

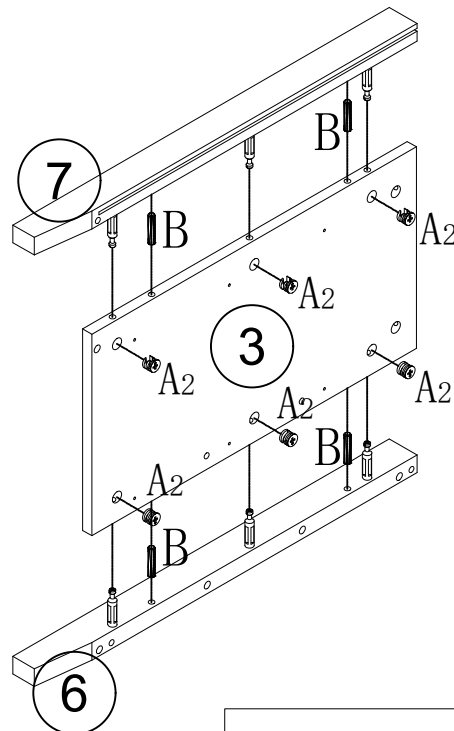
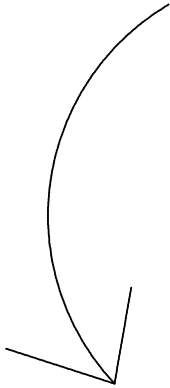
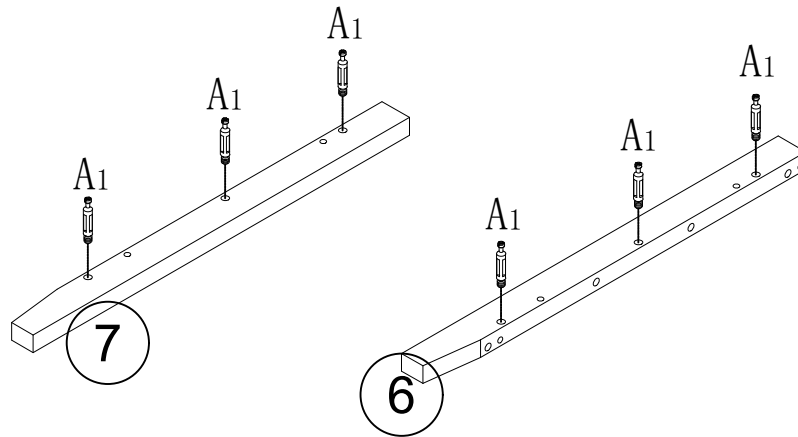
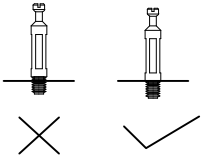
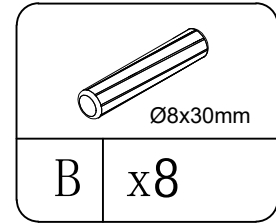
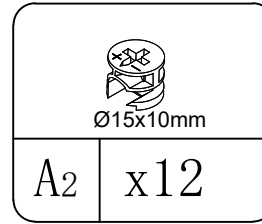
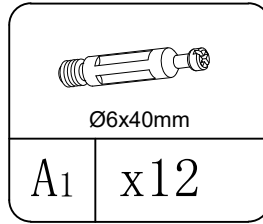
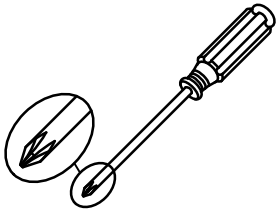

# X2

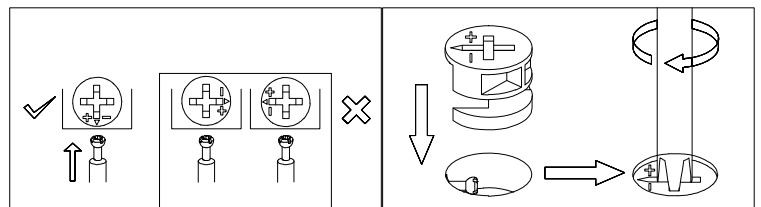

# STEP5

Please tighten the screws after completing all installation.

Por favor, apriete los tornillos después de instalar todo.

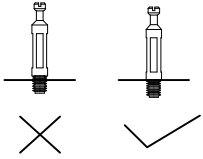
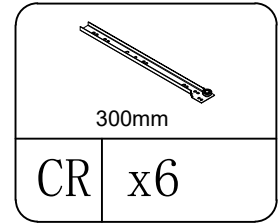
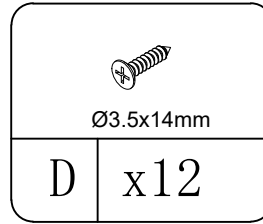
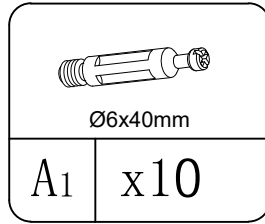
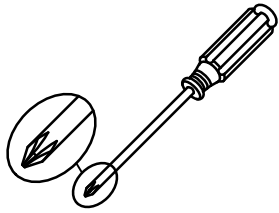

# X2

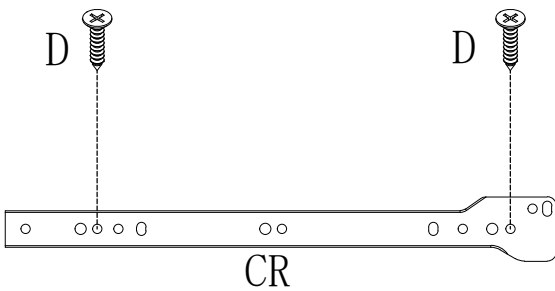
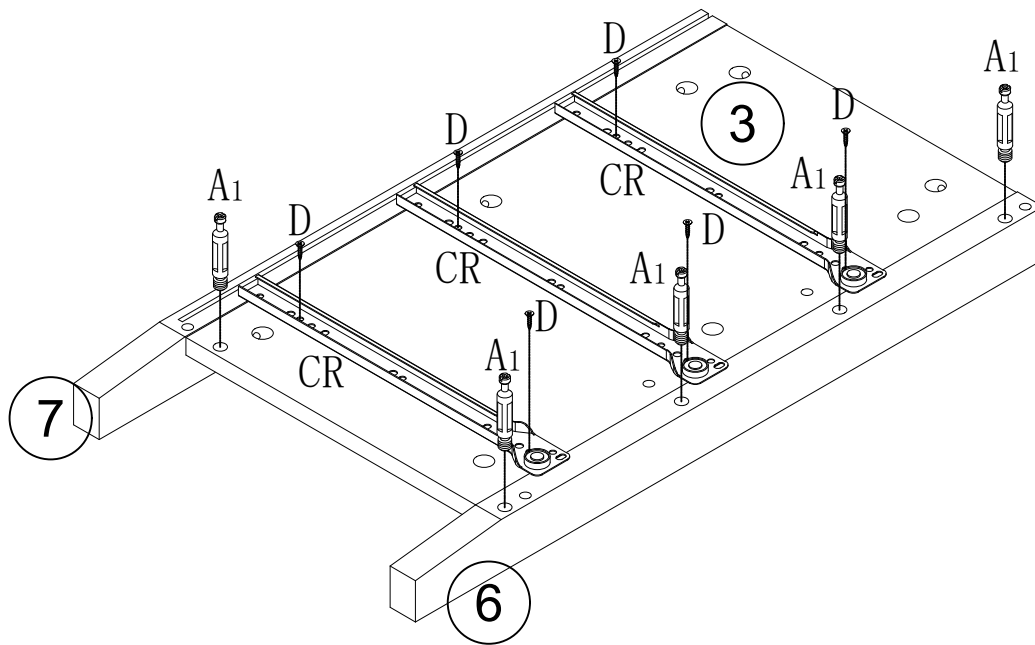

# STEP6

Please tighten the screws after completing all installation.

Por favor, apriete los tornillos después de instalar todo.

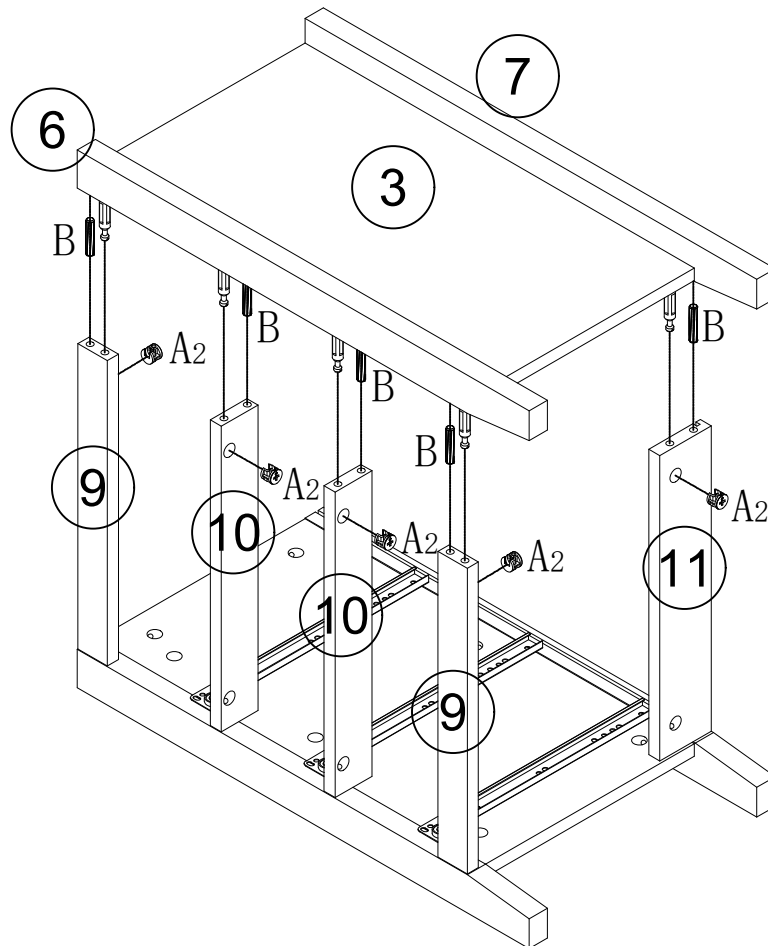
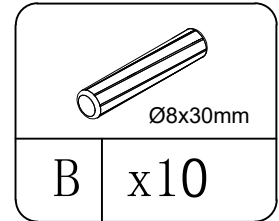
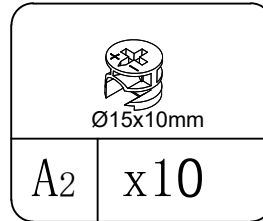
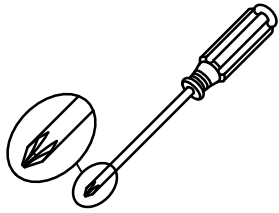

# X2

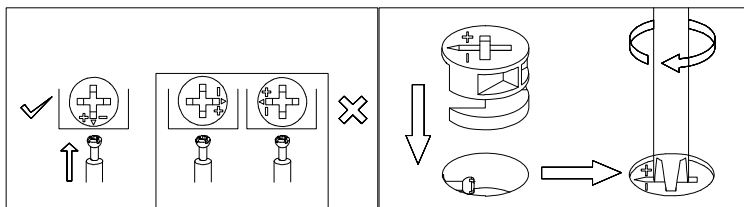

# STEP7

Please tighten the screws after completing all installation.

Por favor, apriete los tornillos después de instalar todo.

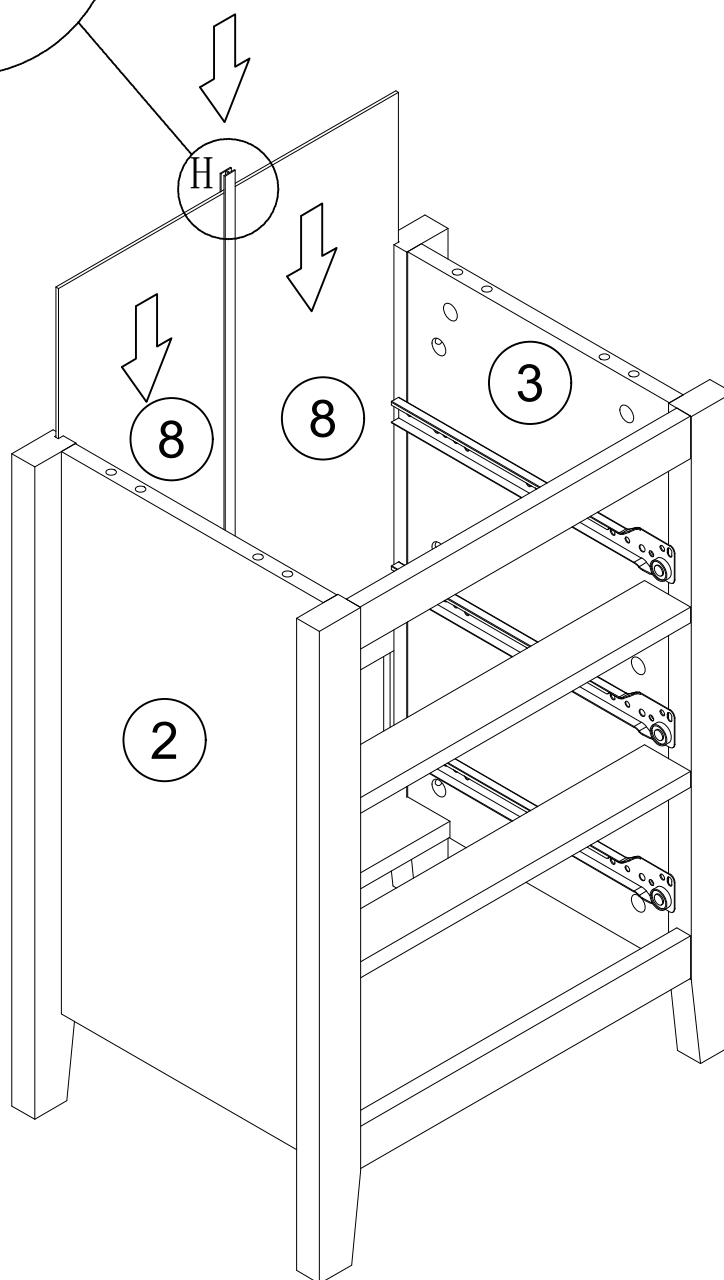
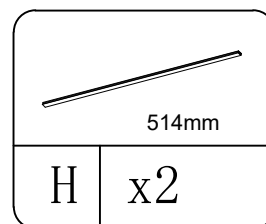
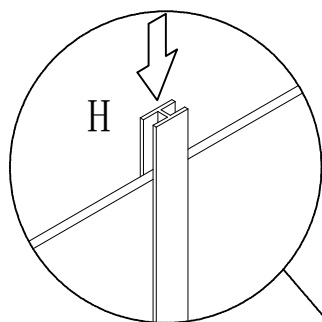

# X2

# STEP8

Please tighten the screws after completing all installation.

Por favor, apriete los tornillos después de instalar todo.

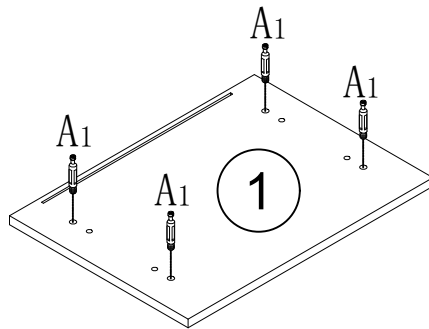
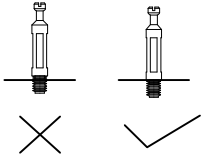
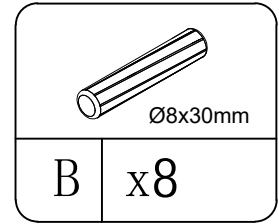
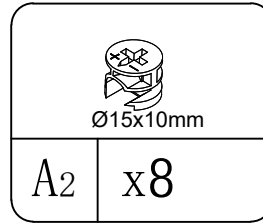
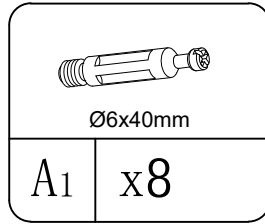
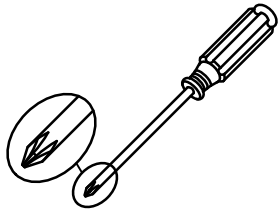

# X2

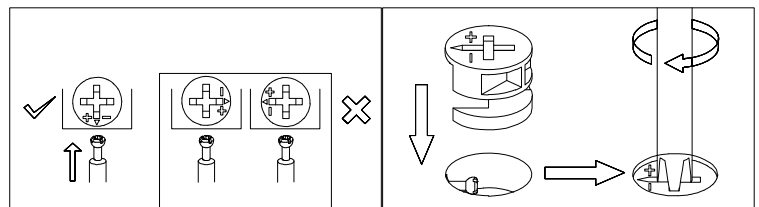
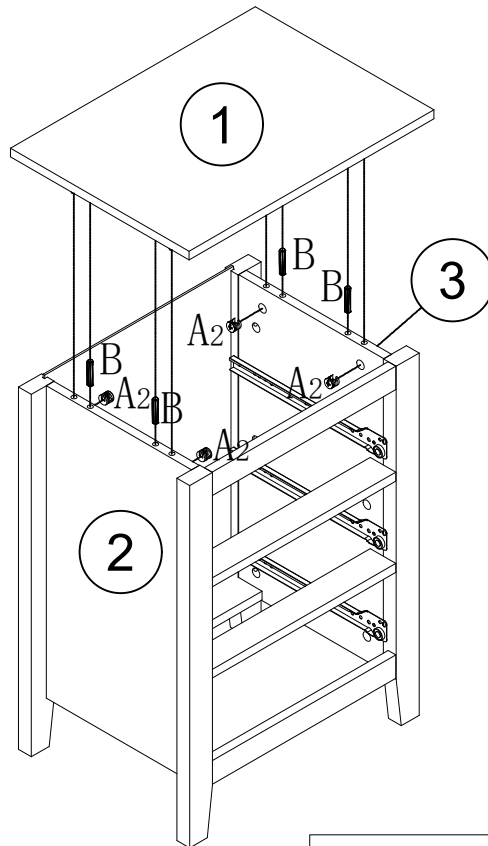

# STEP9

Please tighten the screws after completing all installation.

Por favor, apriete los tornillos después de instalar todo.

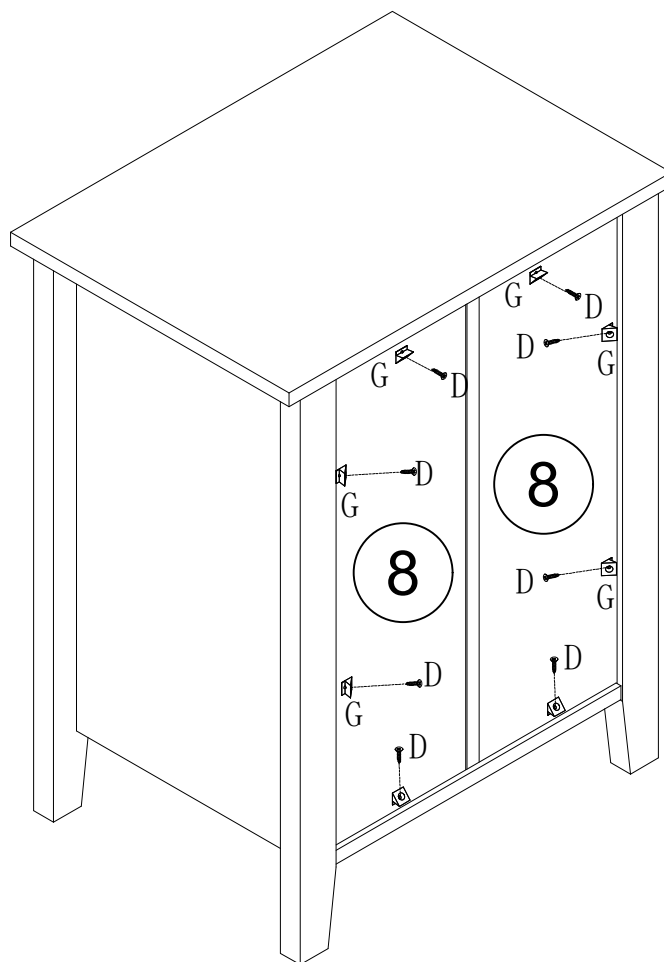
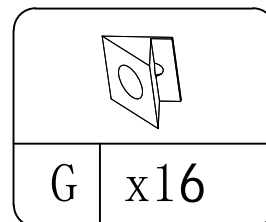
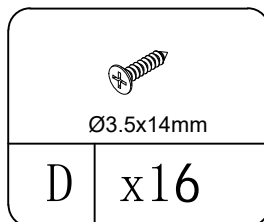
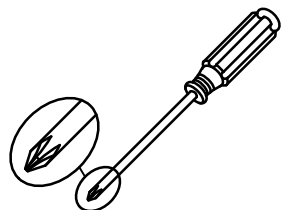

# X2

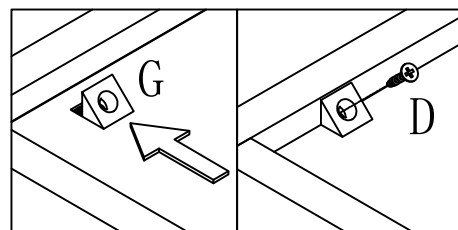

# STEP10

Please tighten the screws after completing all installation.

Por favor, apriete los tornillos después de instalar todo.

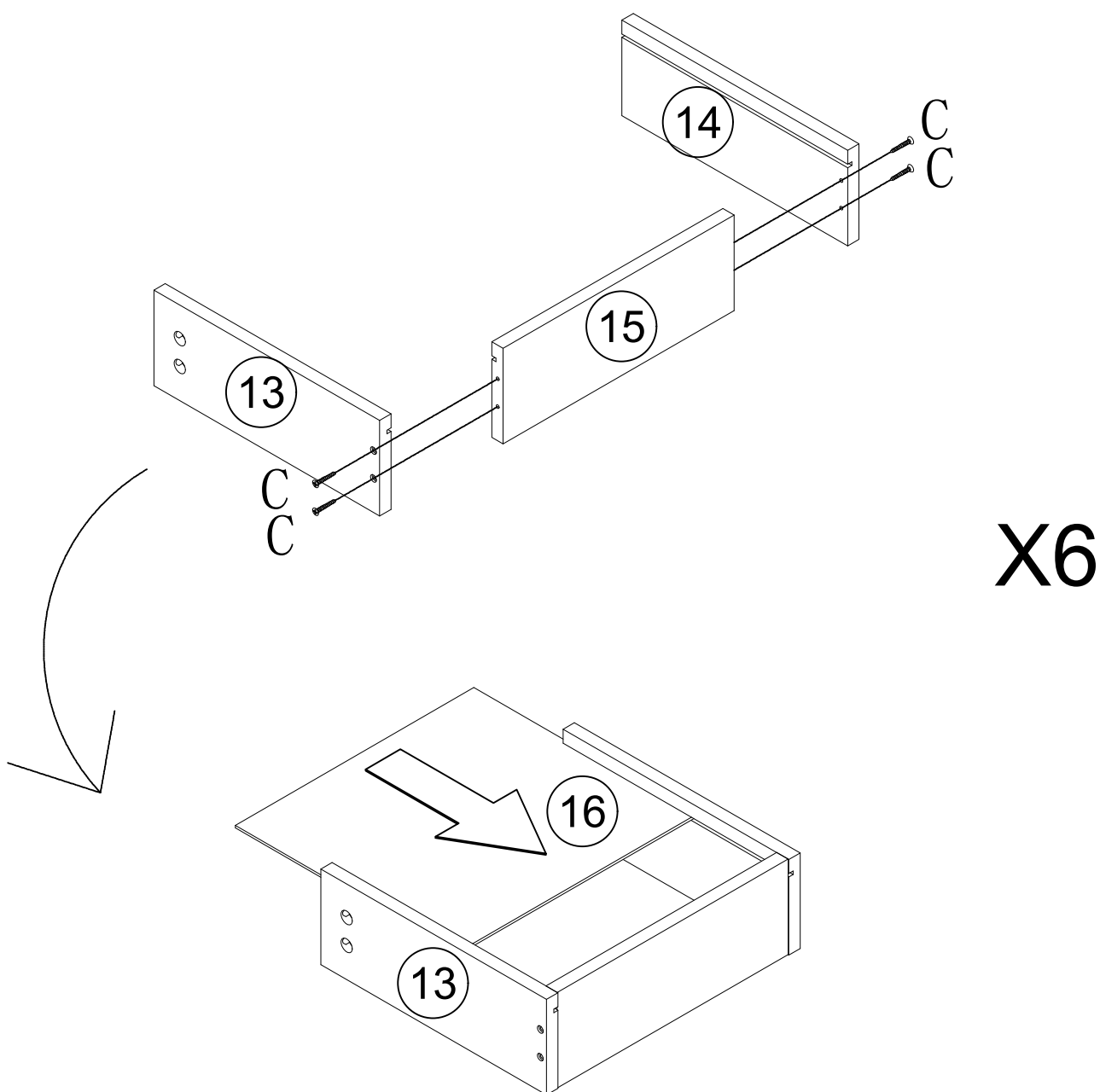
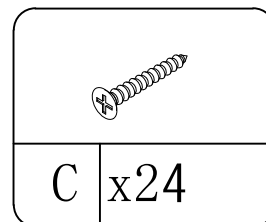
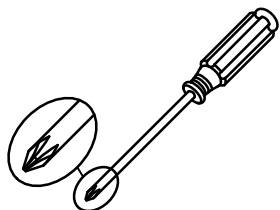

# STEP11

Please tighten the screws after completing all installation.

Por favor, apriete los tornillos después de instalar todo.

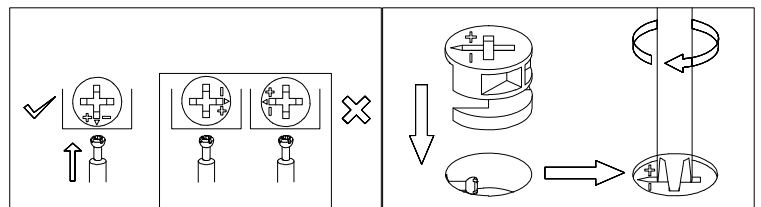
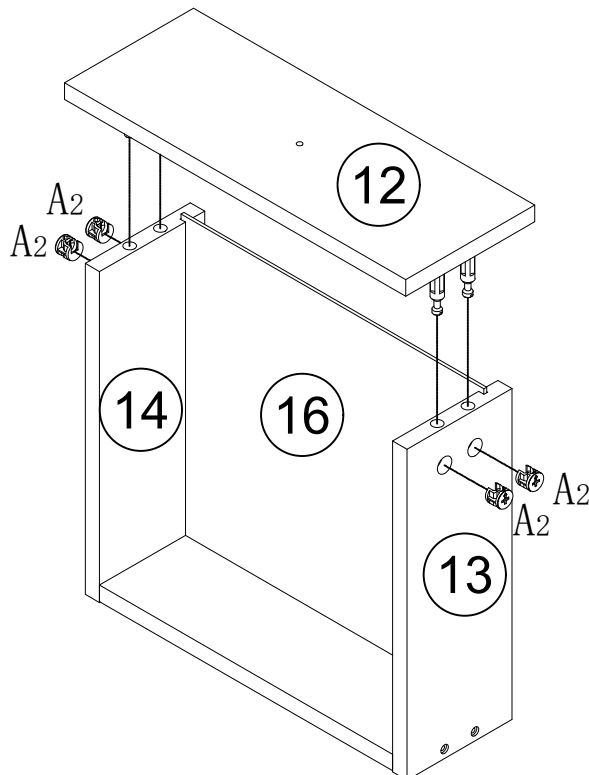
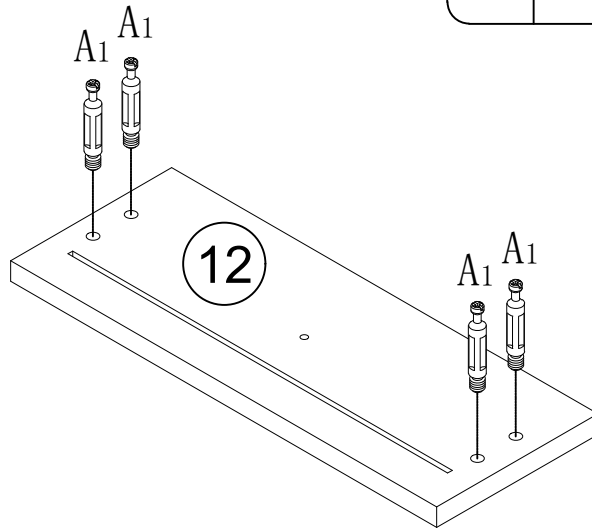
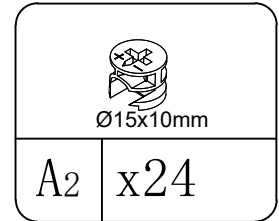
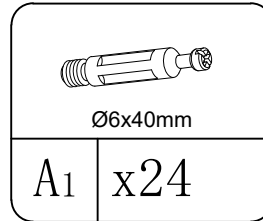
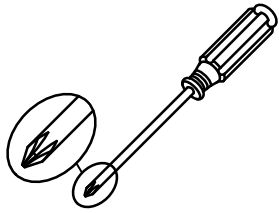

# STEP12

Please tighten the screws after completing all installation.

Por favor, apriete los tornillos después de instalar todo.

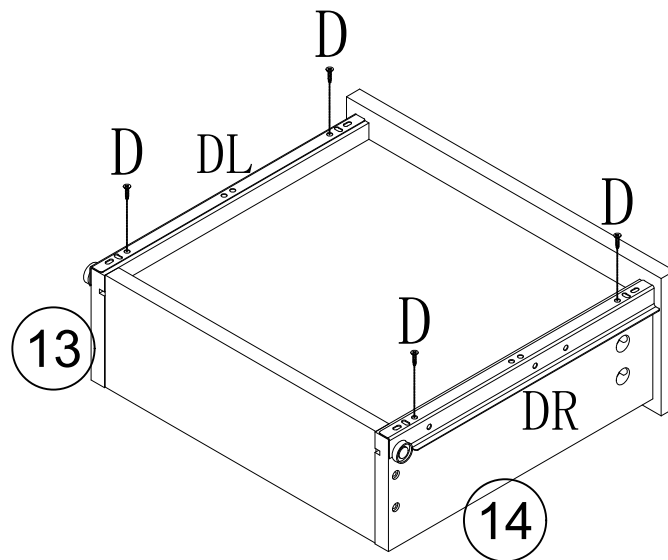
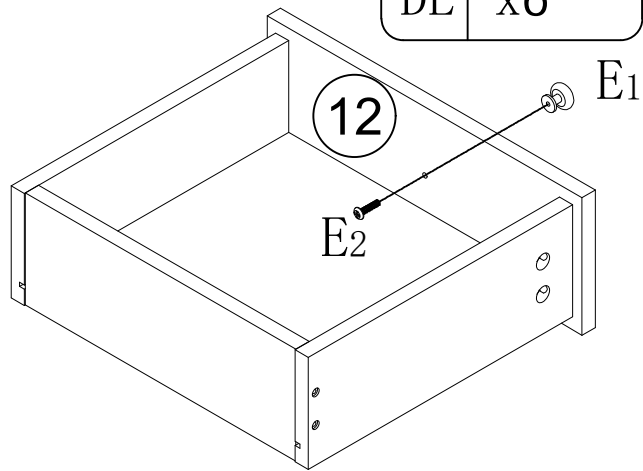
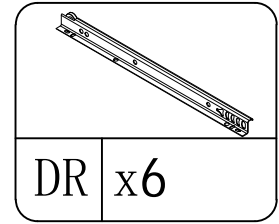
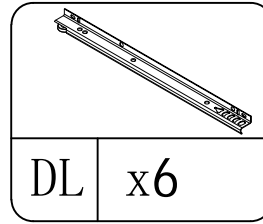
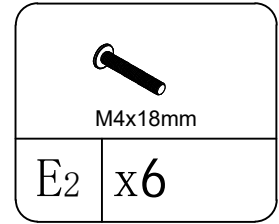
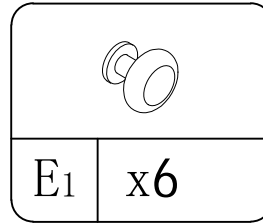
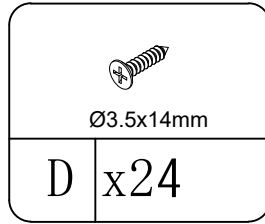
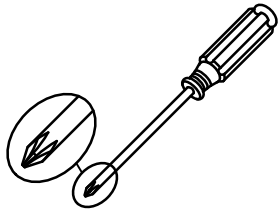

# X6

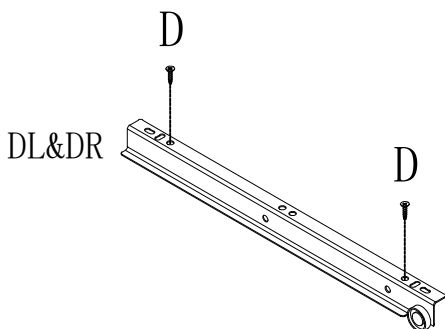

# STEP13

Please tighten the screws after completing all installation.

Por favor, apriete los tornillos después de instalar todo.

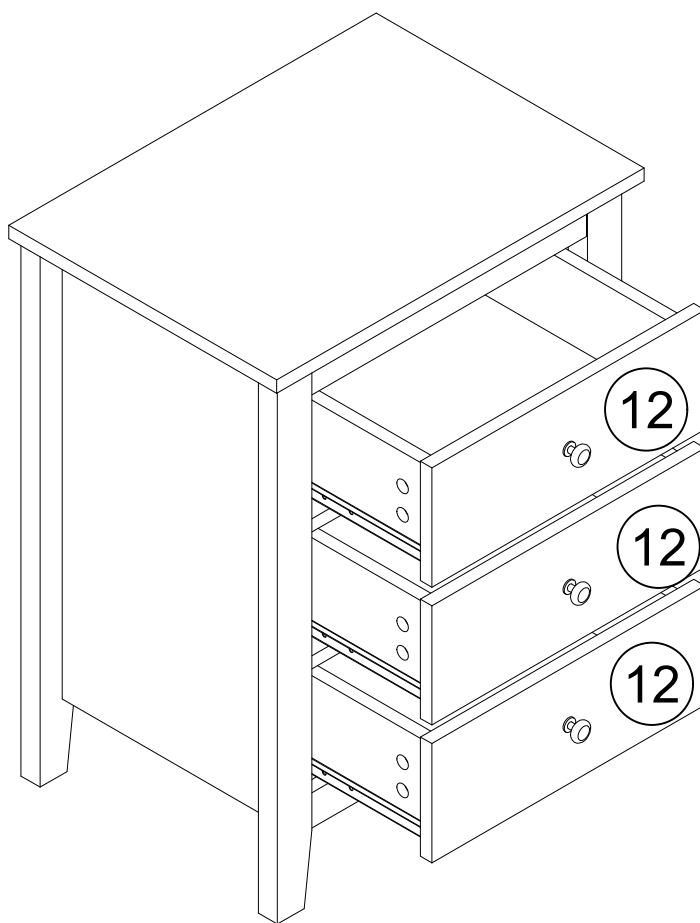
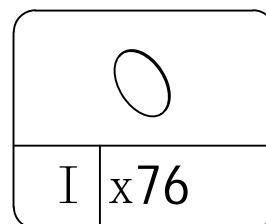

# X2

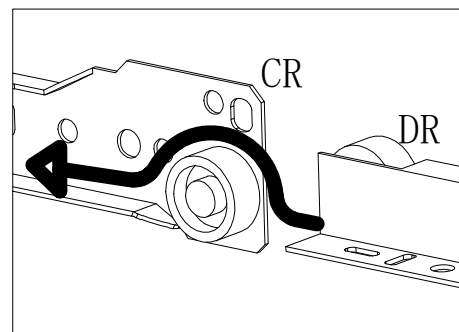
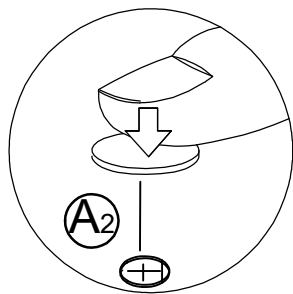
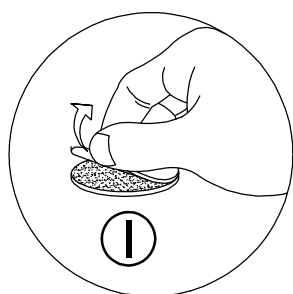

# STEP14

Please tighten the screws after completing all installation.

Por favor, apriete los tornillos después de instalar todo.

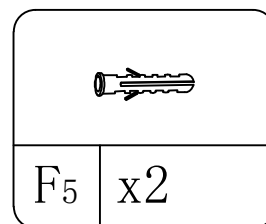
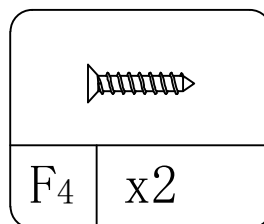
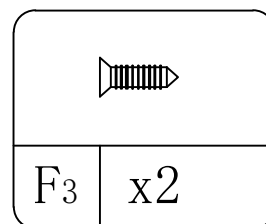
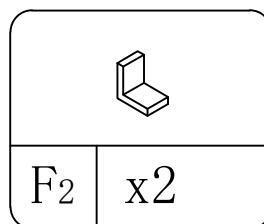
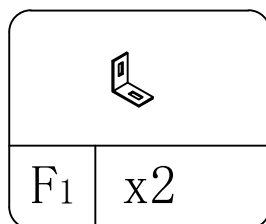

# X2

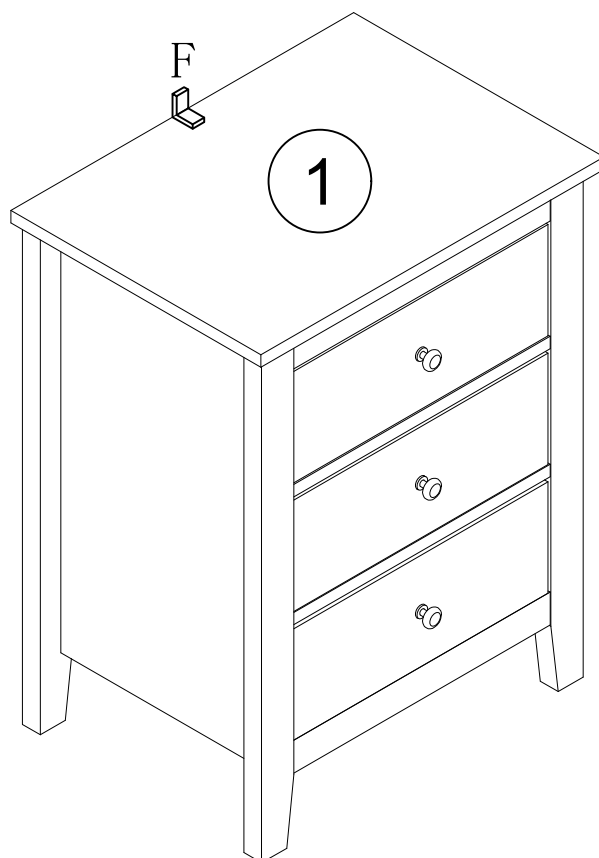

- 
- 
- 
-

#### Prevent Moisture Damage:

Safeguard your laminate furniture by keeping it in a dry environment. Store the furniture away from damp areas and water sources.

#### Sunlight Shielding:

Shield your laminate furniture from direct sunlight to prevent color fading and surface deterioration. Consider using curtains or blinds for protection, especially if direct sunlight exposure is unavoidable.

#### Regular Care:

Maintain your laminate furniture's appearance by gently wiping surfaces with a damp cloth. Avoid using overly wet cloths or abrasive cleaning tools.

#### Avoid Scratches:

Protect the furniture surface from scratches by refraining from placing sharp or hard objects on it. When moving the furniture, be cautious not to scrape the legs against the floor.

#### Proper Weight Distribution:

Prevent structural damage by placing heavy objects on stable support surfaces rather than directly on the laminate furniture's surface. This simple step can prolong the life of your furniture.

Evite daños por humedad:

Proteja sus muebles laminados manteniéndolos en un ambiente seco. Guarde los muebles lejos de zonas húmedas y fuentes de agua.

Protéjalos de la luz solar:

Proteja sus muebles laminados de la luz solar directa para evitar la pérdida de color y el deterioro de la superficie. Considere el uso de cortinas o persianas como protección, especialmente si la exposición directa a la luz solar es inevitable.

Cuidado regular:

Mantenga el aspecto de sus muebles laminados limpiando suavemente las superficies con un paño húmedo. Evite utilizar paños demasiado húmedos o herramientas de limpieza abrasivas.

Evite los arañazos:

Proteja la superficie del mueble de arañazos evitando colocar objetos afilados o duros sobre ella. Al mover el mueble, tenga cuidado de no raspar las patas contra el suelo.

Distribución adecuada del peso:

Evite daños estructurales colocando objetos pesados sobre superficies de apoyo estables en lugar de directamente sobre la superficie del mueble laminado. Este sencillo paso puede prolongar la vida de sus muebles.



## WARRANTY INFORMATION

**Warranty Coverage:** Our warranty provides protection against manufacturing defects in materials and workmanship for a specified period from the date of purchase, as outlined in the accompanying warranty documentation.

**Exclusions:** The warranty does not cover damages resulting from misuse, negligence, accidents, normal wear and tear, unauthorized repairs or modifications, improper assembly, or failure to adhere to the care and maintenance guidelines provided.

## WARRANTY CLAIM PROCESS

**To initiate a return, please follow these steps:**

1. Log into your account and go to the "Your Orders" section.
2. Locate the order containing the item you wish to return.
3. Contact our customer service for assistance in obtaining a prepaid return label.
4. Once you receive the return label, securely affix it to the package.
5. You can then choose to drop off the package at a designated carrier location or arrange for a pickup.
6. After we receive and inspect the returned product, we will initiate the refund process.
7. The refund will be credited back to the original payment method used during the purchase.
8. Typically, refunds are processed within 3-5 business days.

**Cobertura de la garantía:** Nuestra garantía proporciona protección contra defectos de fabricación en materiales y mano de obra durante un período determinado a partir de la fecha de compra, como se indica en la documentación de garantía adjunta.

**Exclusiones:** La garantía no cubre los daños resultantes de uso indebido, negligencia, accidentes, desgaste normal, reparaciones o modificaciones no autorizadas, montaje incorrecto o incumplimiento de las directrices de cuidado y mantenimiento proporcionadas. las directrices de cuidado y mantenimiento proporcionadas.

## **PROCESO DE RECLAMACIÓN DE LA GARANTÍA**

**Para iniciar una devolución, siga estos pasos:**

1. Accede a tu cuenta de y ve a la sección "Tus pedidos".
2. Localiza el pedido que contiene el artículo que deseas devolver.
3. Ponte en contacto con nuestro servicio de atención al cliente para que te ayuden a obtener una etiqueta de devolución prepagada.
4. Después de que recibamos e inspeccionemos el producto devuelto, iniciaremos el proceso de reembolso.
5. El reembolso se abonará de nuevo al método de pago original utilizado durante la compra.
6. Normalmente, los reembolsos se procesan en un plazo de 3 a 5 días laborables.
7. Una vez que reciba la etiqueta de devolución, fíjela firmemente al paquete.
8. A continuación, puede optar por depositar el paquete en el lugar designado por el transportista o solicitar que lo recojan.