

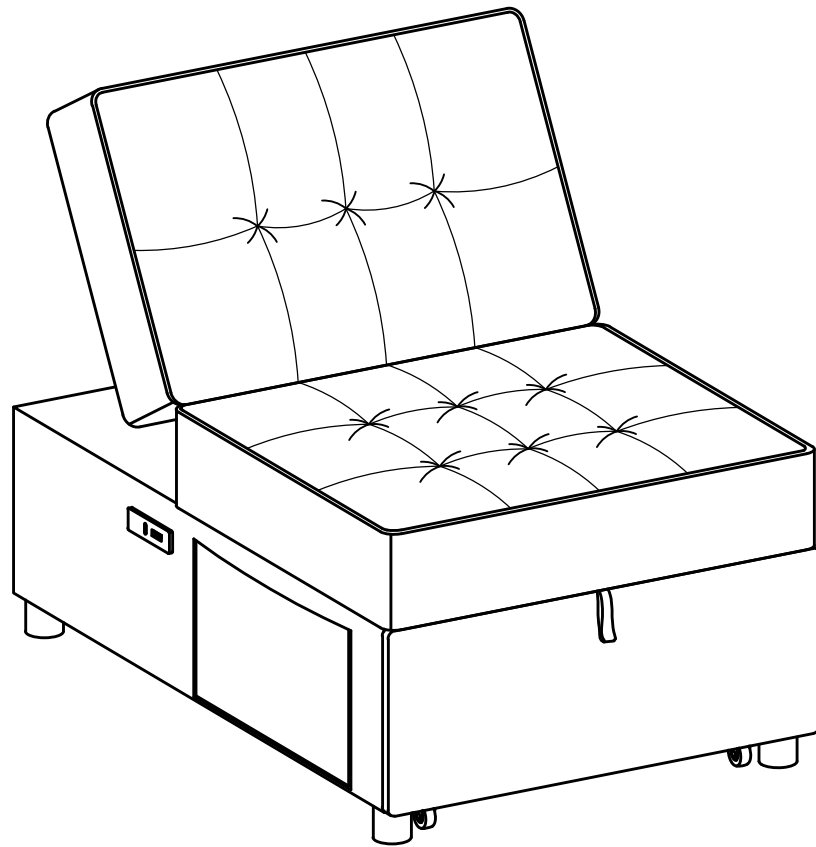

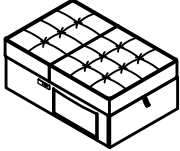

# ASSEMBLY INSTRUCTION



# COMPONENT LIST

NO.	DRAWING	QTY	DESCRIPTION
(A)		1	Seat and Backrest
(B)		4	Round Leg
(C)		4	Wheels
(D)		8	Bolt 1/4" x 20mm
(E)		1	Allen Key

\* Take out the (A) (B) (C) (D) (E)

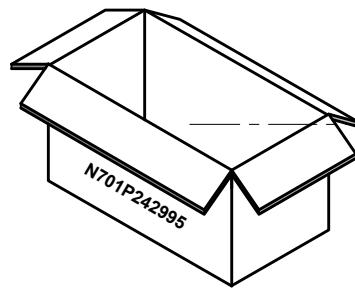

(A)

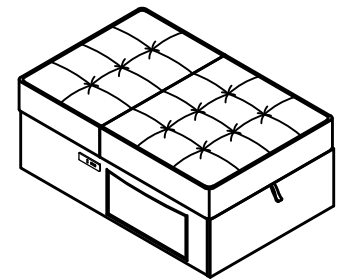

(B)



x 4 pcs

(D)



x 8 pcs

(C)



x 4 pcs





(E)

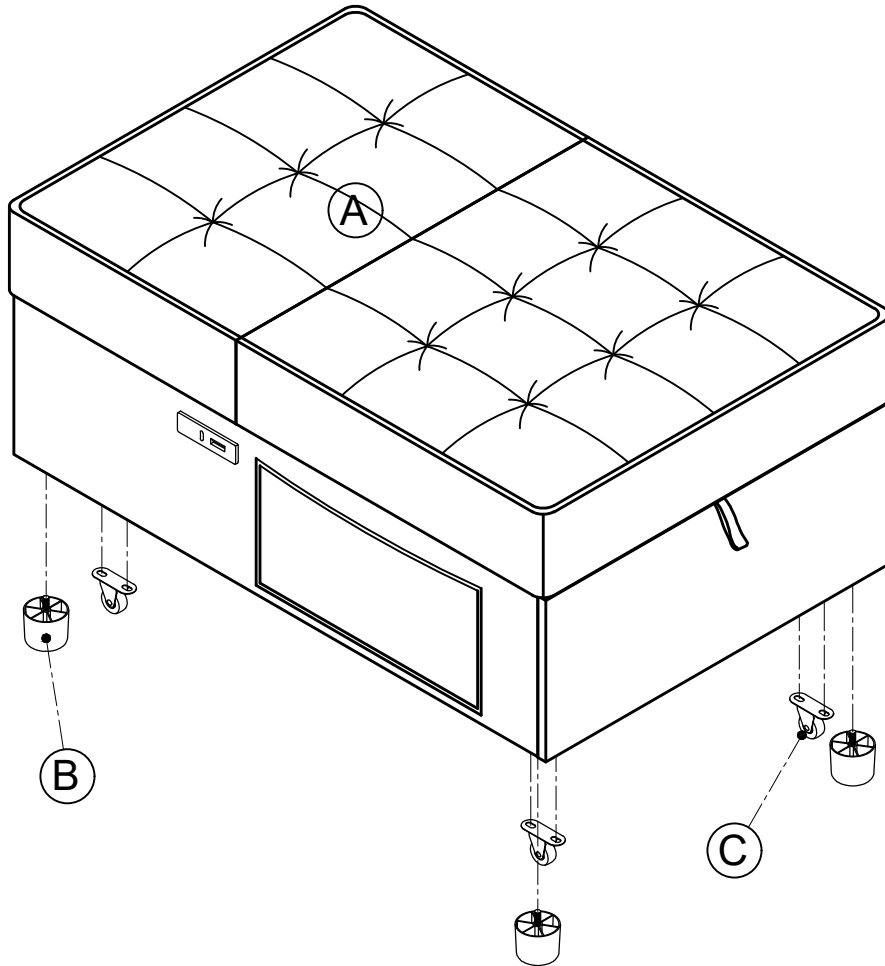

x 1 pc

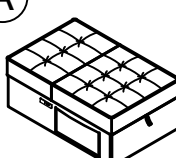
# PARTS LIST



<p>(A)</p> 	<p>(B)</p> 	<p>(C)</p> 	<p>(D)</p> 	<p>(E)</p> 
<p>Seat and Backrest x 1 pc</p>	<p>Round Leg x 4 pcs</p>	<p>Wheels x 4 pcs</p>	<p>Bolt 1/4" x 20mm x 8 pcs</p>	<p>Allen Key x 1 pc</p>

**STEP 1:**

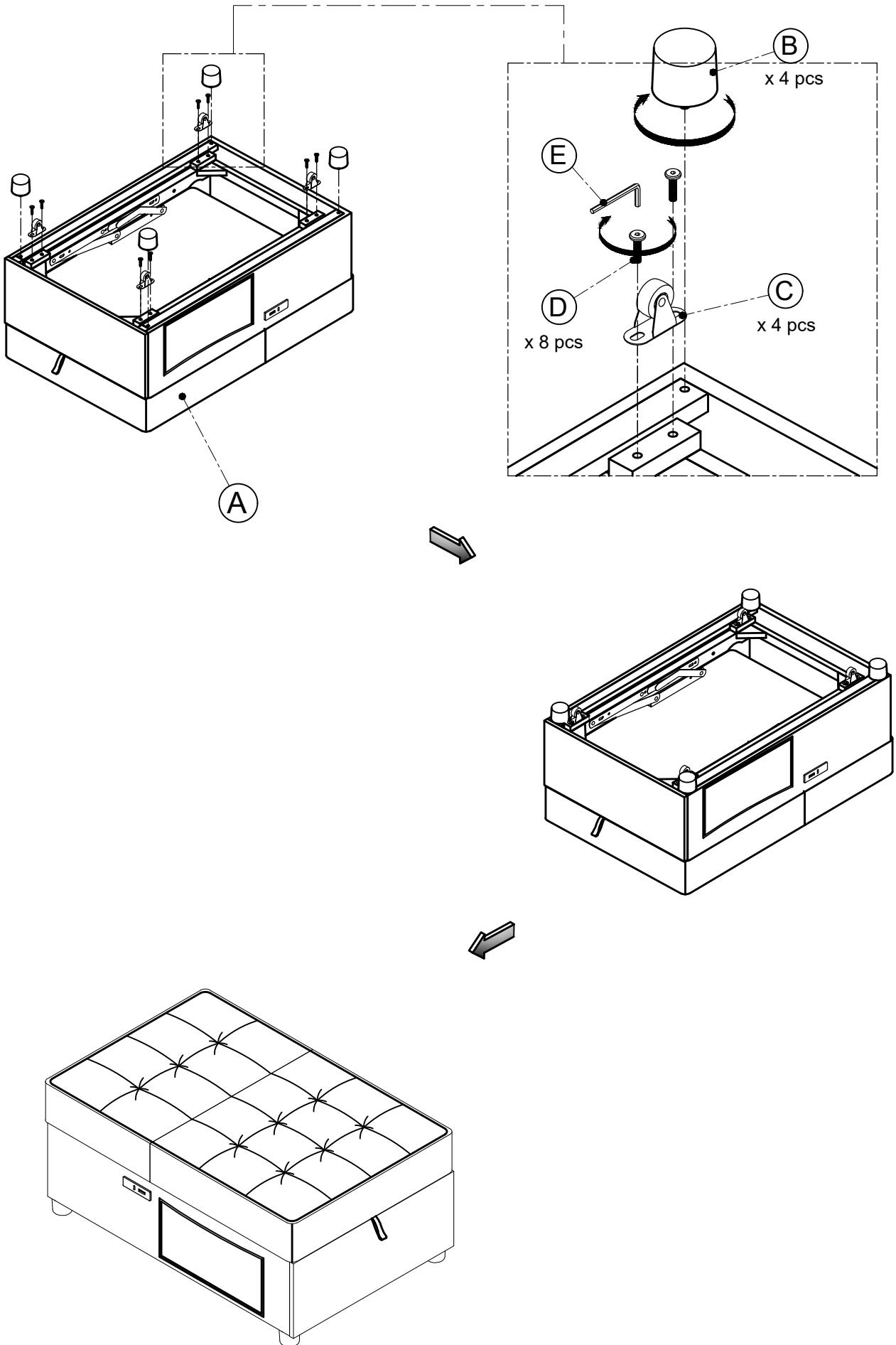

# Helpful Hints

- Sofa bed can transform into a sleeper.
- Move your new furniture carefully, with two people lifting and carrying the unit to its new location.
- Your furniture can be disassembled and reassembled to move.
- Clean the product with a soft damp cloth. DO NOT use harsh chemicals or abrasive cleaners.

## COMPLETED

