



INSTRUCTIONS

Ada

Assembly Instruction

1. Before installation please refer to the manual with the correct quantity of components.
2. For safety issues, please always wear protective glove during installation.
3. Install products on a carpet or mat to prevent damage to floors.
4. Recommendation of 1-2 people for easier installation.
5. Please note it is difficult to detach gas lift once it is installed.
6. To detach, please first disengage the mechanism from the bottom part of chair.
7. Assembly video is available, please contact us if necessary.

Then with a plastic hammer gently tap one side of the base, thus loosen up and detach the gas lift from the base.

Then in order to detach the gas lift from the mechanism, turn it upside down and use the plastic hammer gently tap on the mechanism.

1-YEAR LIMITED WARRANTY

1. Provides limited warranty coverage to the original purchaser of this product for a period of one year from the date of purchase against defects in materials or workmanship of components.

As used in this Warranty, "defect" means imperfections in components which substantially impair the utility of the product. This Warranty gives you specific legal rights, and you may also have other rights which vary from state to state.

2. There is no warranty coverage for defects or conditions that result from the **failure** to follow product assembly instructions, information or warnings, misuse **Or** abuse, intentional damage, fire, flood, alteration or modification of the product, or use of the product in a manner inconsistent with its intended use, nor any condition resulting from incorrect or inadequate maintenance, cleaning, or care. There is also no warranty coverage for rented products or any products purchased "used" or "as is", at a distress or going-out-of-business sale, or from a liquidator.

3. As the exclusive remedy under this Warranty, we (at our sole option) will repair or replace any defective furniture component. We may require independent confirmation of the claimed defect and proof of purchase. Replacement parts will be warranted for only the remaining period of the original Warranty. **SHALL HAVE NO LIABILITY for ANY INCIDENTAL OR CONSEQUENTIAL DAMAGES OF ANY KIND** and all such damages are **EXCLUDED FROM THIS WARRANTY**, such as loss of use, disassembly, transportation, labor or damage to property on or near the product. Some states do not allow the exclusion or limitation of incidental or consequential damages, so the above limitation or exclusion may not apply to you.



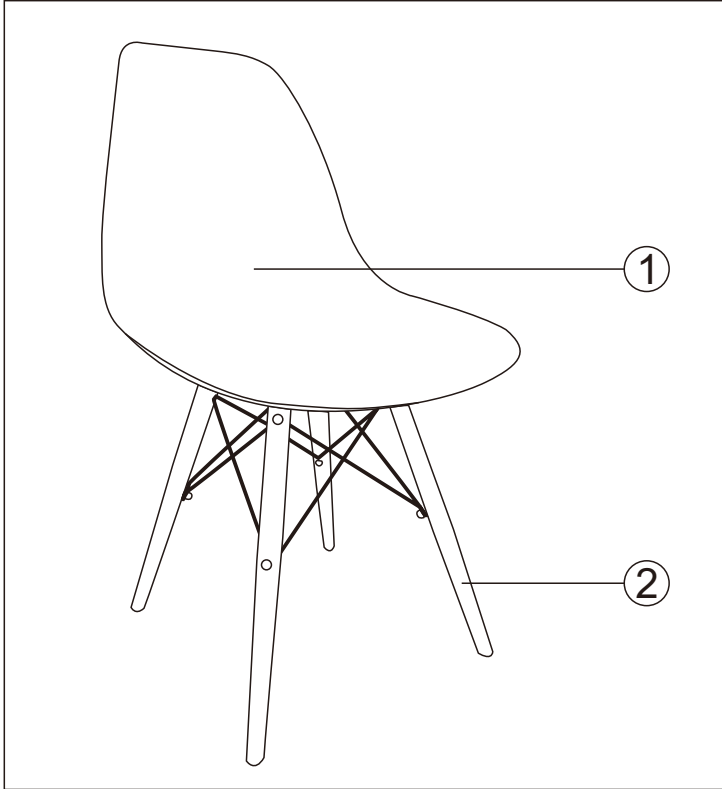

4. This Warranty applies only to warranted defects that first arise and are reported to within the warranty coverage period. The Warranty cannot be transferred to subsequent owners or users of the product, and it shall be immediately void in the event the product is resold, transferred, leased or rented to any third party or person other than the original purchaser.

5. THERE ARE NO OTHER WARRANTIES APPLICABLE TO THIS PRODUCT. Under the laws of certain states, there may be no implied warranties from and all implied warranties, **INCLUDING ANY IMPLIED WARRANTY OF MERCHANTABILITY OR FITNESS FOR A PARTICULAR PURPOSE** are disclaimed where allowed by law. **TO THE EXTENT ANY IMPLIED WARRANTIES ARE APPLICABLE, ANY IMPLIED WARRANTIES, INCLUDING ANY IMPLIED WARRANTY OF MERCHANTABILITY OR FITNESS FOR A PARTICULAR PURPOSE, ARE LIMITED IN DURATION TO THE DURATION OF THIS EXPRESS WARRANTY** or the minimum period allowed by law, whichever is shorter. Some states do not allow limitations on how long an implied Warranty lasts, so the above limitation may not apply to you.

PARTS LIST



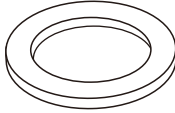

1	BACK
2	FOOT

A	Bolt	B	metal pad	C	Rubber pad	D	Allen key
							
4pcs M6x14mm		4pcs ϕ 16x ϕ 6. 5x1mm		4pcs ϕ 25x ϕ 15x4mm			

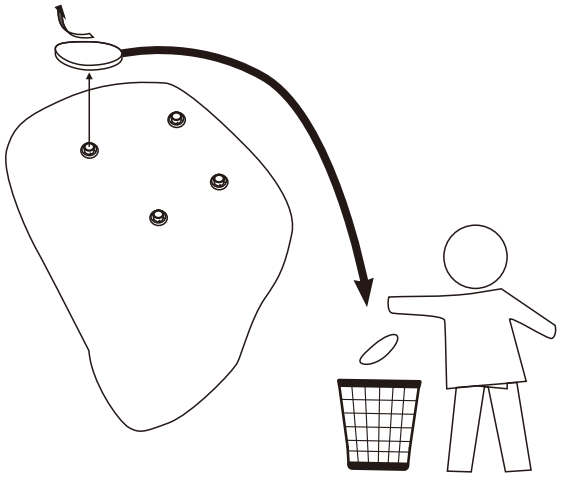
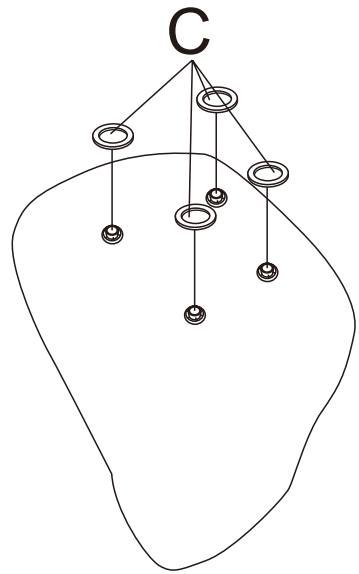
Product assembly:

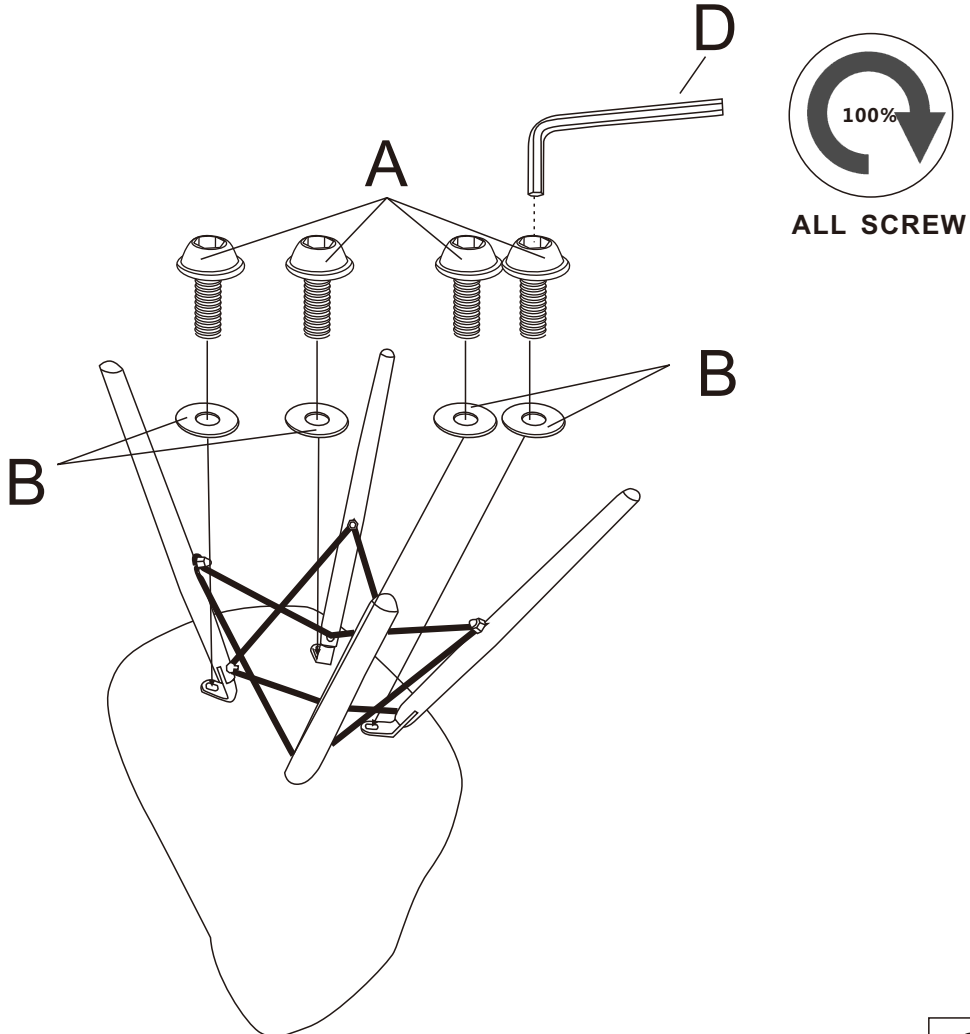
<p>C</p>  <p>4pcs φ 25x φ 15x4mm</p>	 <p>1</p>	 <p>2</p>
--	---	---

<p>A</p>  <p>4pcs M6x14mm</p>	 <p>100% ALL SCREW</p>
<p>B</p>  <p>4pcs φ 16x φ 6.5x1mm</p>	
<p>D</p> 	

Finish

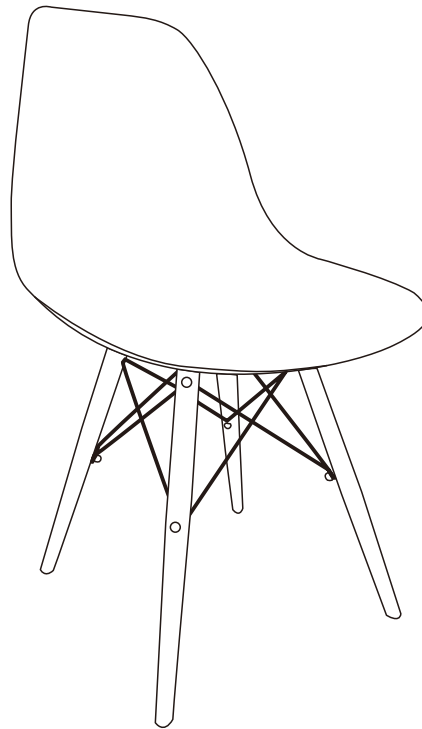

4

Maintenance and Repair

To protect your furniture, we recommend:

1. Avoid placing furniture in direct sunlight.
2. Please do not place the product near windows.
3. Please do not put sharpe objects (such as knife) directly on the furniture as sharpe objects could scratch and damage the surface.
4. Please do not place high temperature materials directly on the surface of furniture.
5. Please do not leave liquids (such as water, alcohol, perfume, nail polish, juice etc.) on the product.
6. Clean the furniture with dry and clean rag that is not easy to depilate. Please do not use any detergent as it could damage the surface.
7. Please do not stand on the chair or use the chair as ladder.
8. A chair can only sit one person at a time.