

# Assembly Instruction

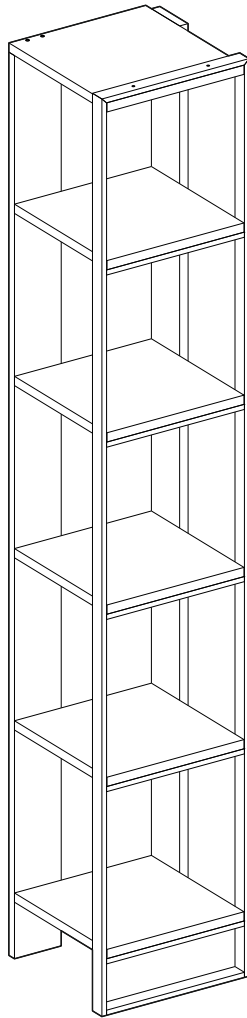



Valued Customer,

We design and carefully manufacture our products for our customers, We wish that our customers to have fun while they are doing their new furniture

The product you just purchased was subjected to all sorts of tests and controls before sending out to you.

Hope you enjoy your new furniture.

Değerli Müşterimiz,

Ürünlerimizi siz değerli müşterilerimiz için tasarlıyor ve özenle üretiyoruz. Müşterimizin yeni ürünlerini kurarken eğlenmesini istiyoruz.

Size kargolamadan önce, satın almış olduğunuz ürünün tüm kontrolleri yapıyoruz.

Yeni ürününüz evinize çok yakışacak.



Before starting, please check all components and accessories according to the provided list. If you purchased more than one product, to prevent confusion, be sure that you completed the first product, then start the next one. Please make sure that you select correct numbered part and use specific connector to assemble. We do not recommend any modification or rotation in assembly. Please follow the manual carefully.

Kuruluma başlamadan önce, lütfen tüm aksesuarları elinizdeki kurulum talimatına göre kontrol ediniz. Eğer birden fazla ürün satın aldıysanız, karışıklığı önlemek için lütfen ürünleri ayrı ayrı kurunuz. Bir ürünü kurmadan önce diğer ürüne başlamayınız. Ürünü kurarken kurulum talimatına göre hareket ediniz. Ürünüze ekleme yapmanızı tavsiye etmiyoruz.



Furniture parts are going to several manufacturing procedures. During this process, parts can have little dust or marks. Please clean the parts with damp cloth before assembly to get the best result. Usual cleaning would be suffice.

Ürününüz üretilirken pek çok aşamadan geçiyor. Bu süreç boyunca üzerinde toz ve bazı işaretler olabilir. Tozları temiz ve nemli bir bez ile silebilirsiniz. İşaretleri ise tiner yardımıyla çıkarabilirsiniz.



Although all products are carefully manufactured and packed, sometimes we experience damage during transportation. In such cases, please check the damaged part, note the part number written on the part and do not hesitate to contact us

Ürünlerimiz özenle üretilmesine ve dikkatle paketlenmesine rağmen, bazen taşıma esnasında hasar meydana gelebilir. Böyle durumlarda hasar gören parçayı kurulum talimatı yardımıyla tespit ederek bizden isteyebilirsiniz. Bir sorunla karşılaştığınızda bizimle iletişime geçmekten çekinmeyiniz.

Do not use your furniture for out of purposes. If you would like to use it out of purpose or would like to do some modification or rotation, please contact us for more details.

Lütfen ürününüzü kullanım amacı dışında kullanmayınız. Böyle durumlarda üretici firma hiçbir sorumluluk kabul etmemektedir.

Please do not expose your furniture with excessive heat, cold and humidity because product can be affected negatively.

Ürünü uzun yıllar boyunca kullanmak istiyorsanız, aşırı ısıya, soğuğa ve neme maruz bırakmayınız.

If you need your product to mount on the wall, Please use suitable rawlplug for your wall type. We send you rawlplugs suitable for concrete and brick walls.

Eğer ürününüzü duvara monte etmeniz gerekiyorsa, Gönderilen dübel beton duvarlara uygundur. Lütfen duvar tipinize uygun dübel temin ediniz.



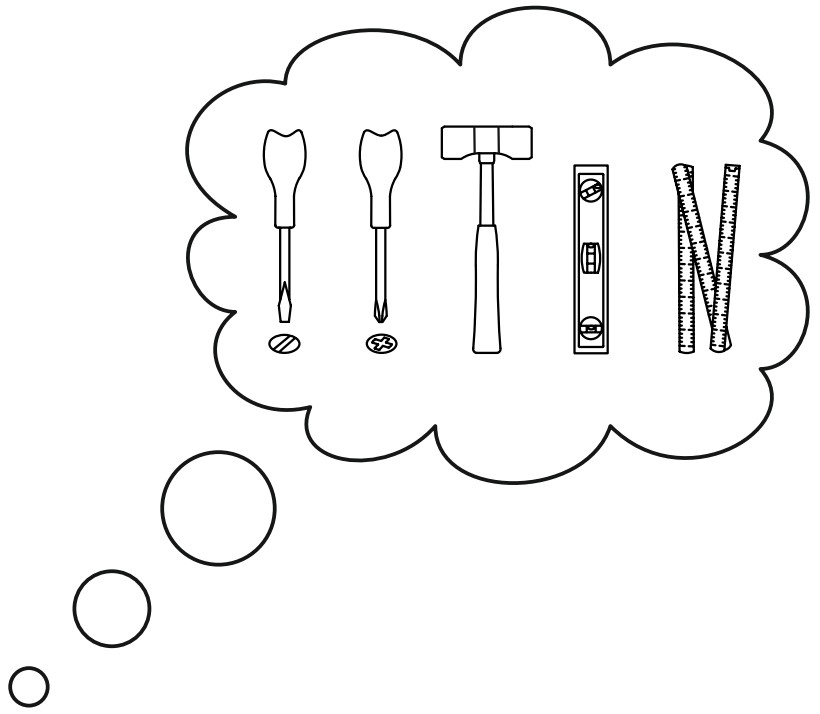
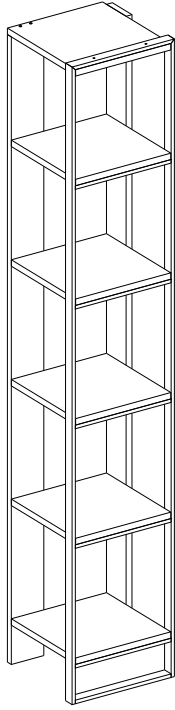

## Tools & Installation Components

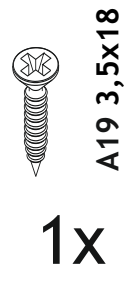
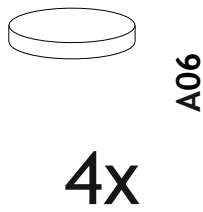
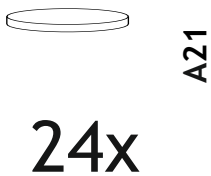
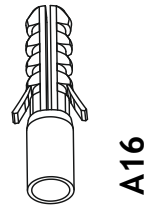
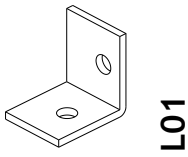
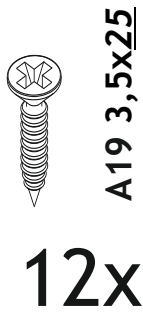

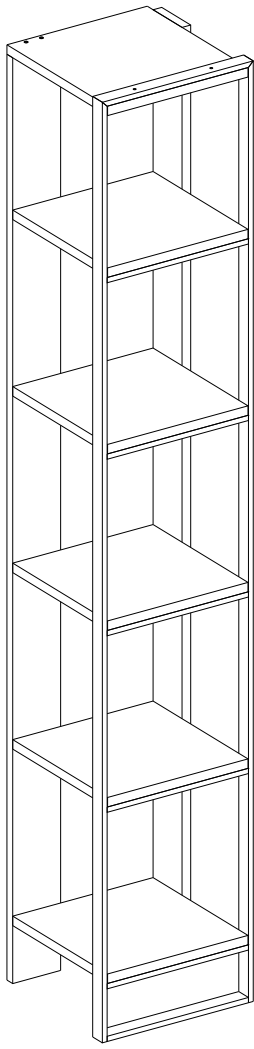

## Disassembled Parts

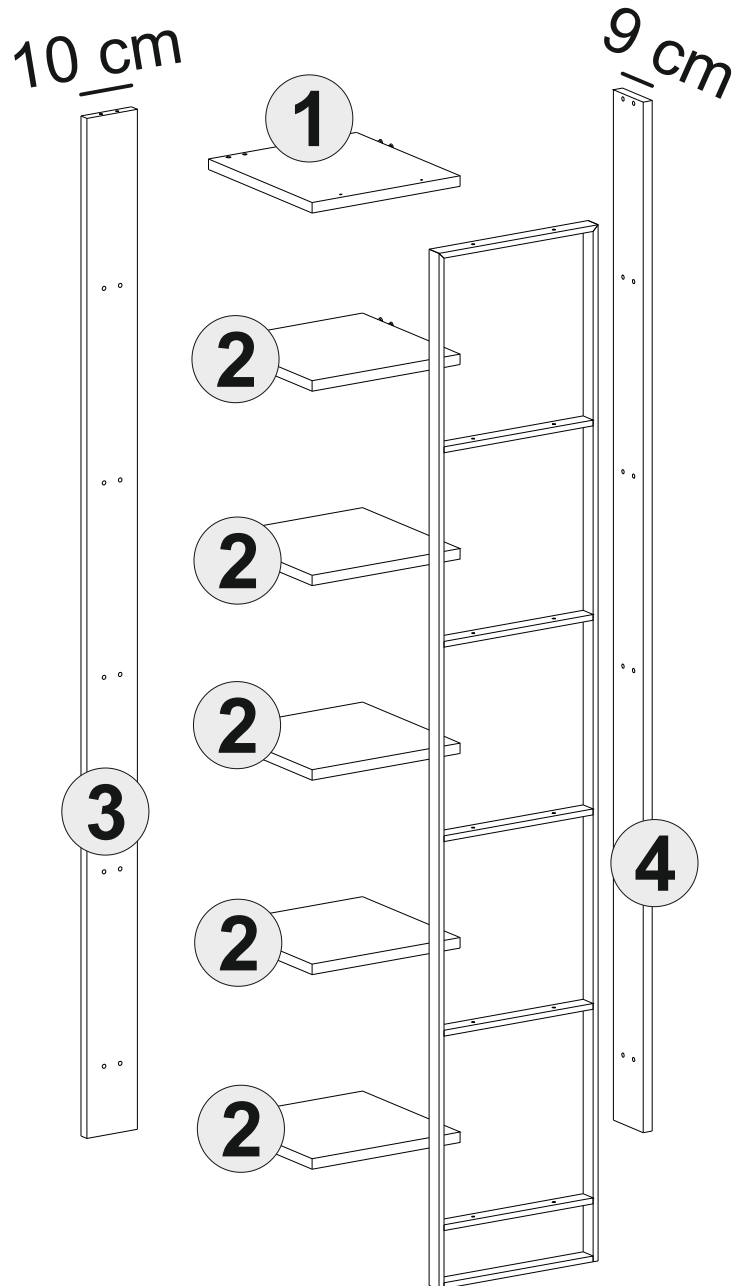

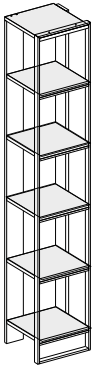

**1**

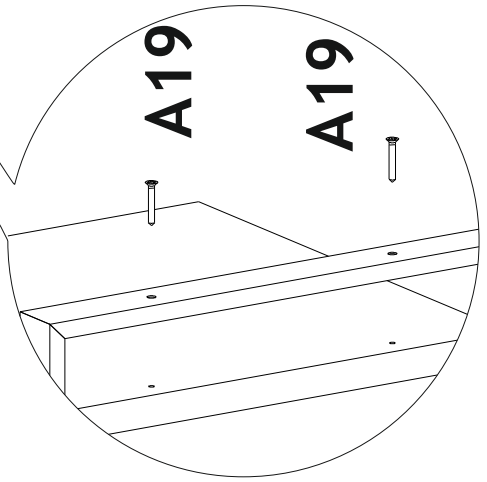
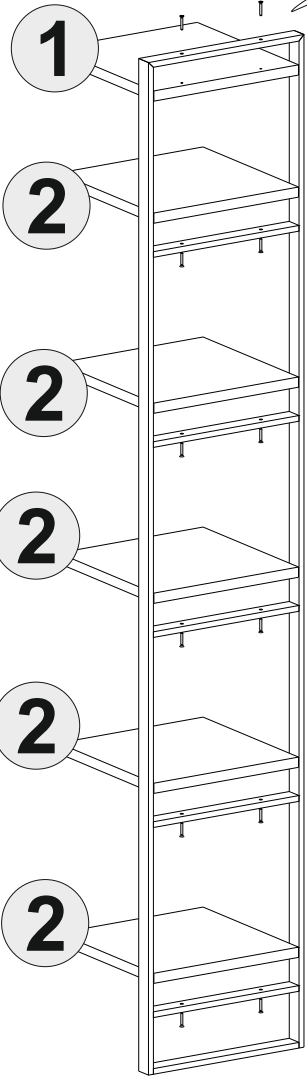

**2**

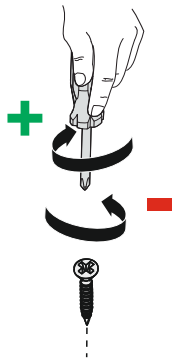
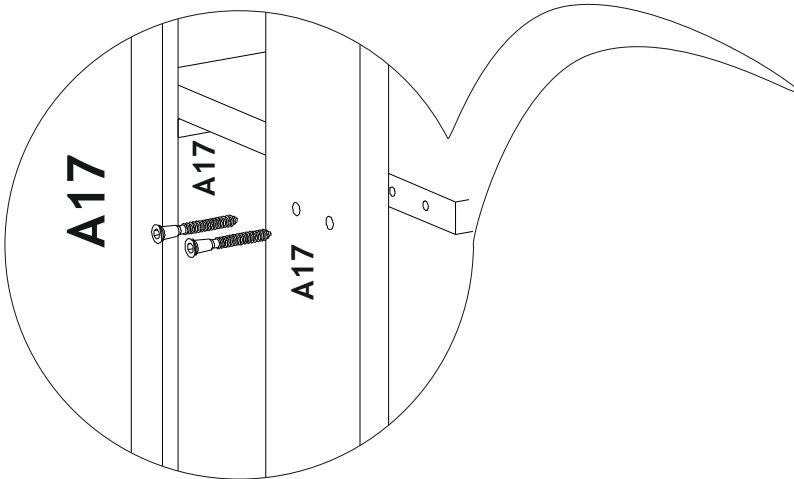
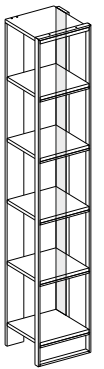
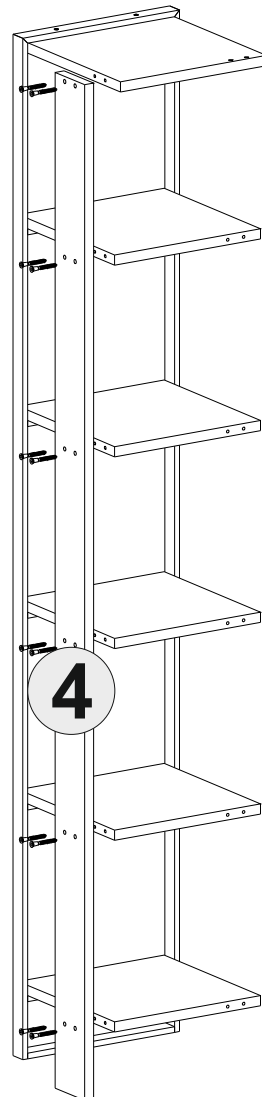

**3**

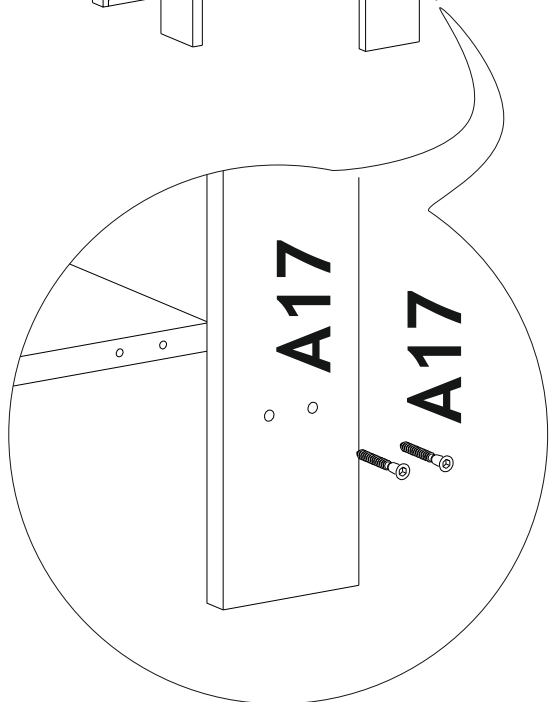
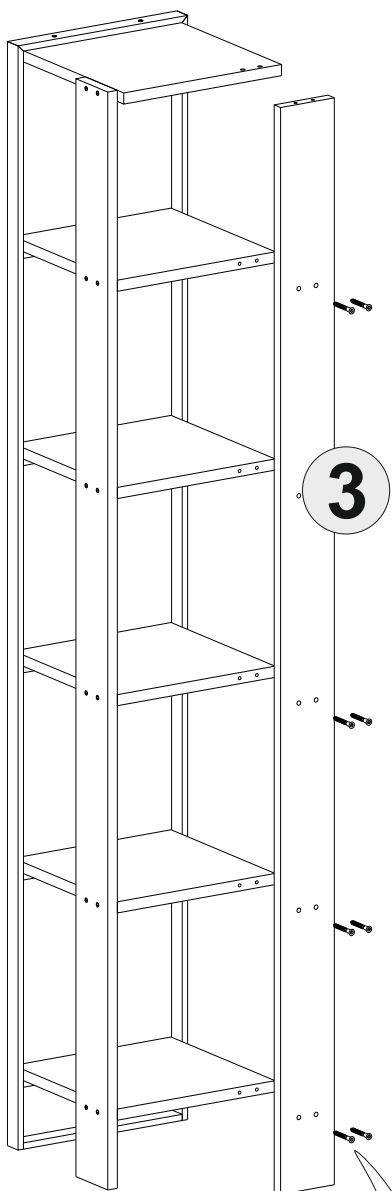

**4**

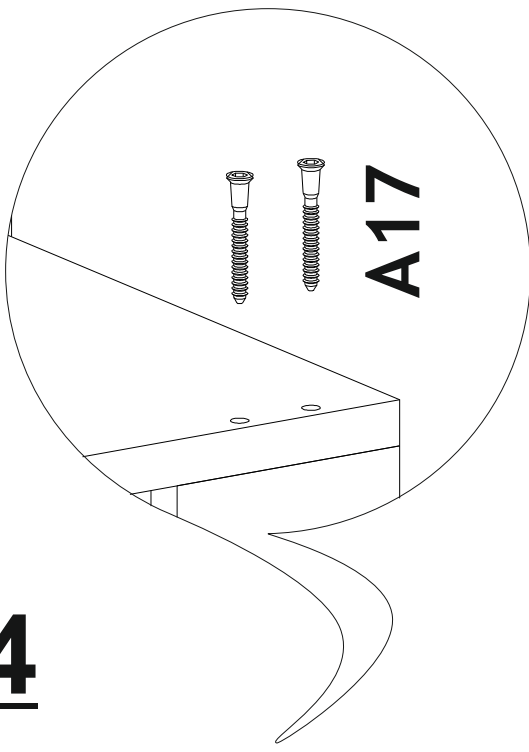

**A17**

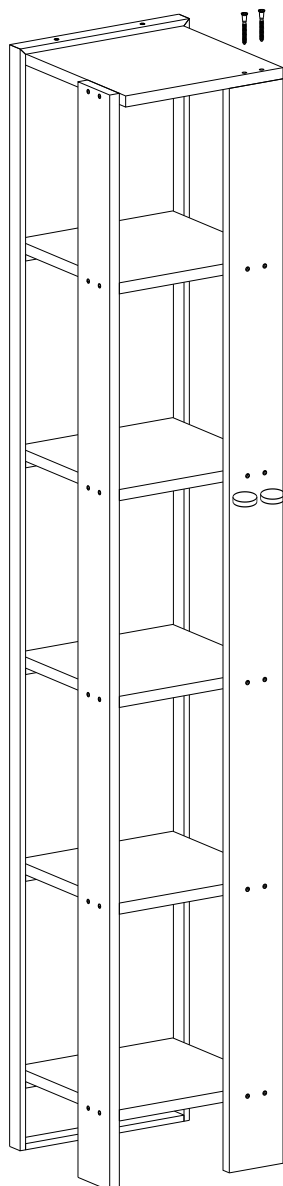

**A21**

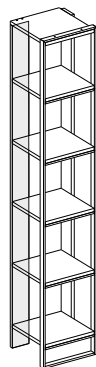

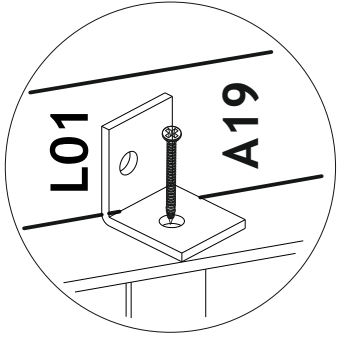

**5**

