

STEEL
BARN DOOR
HARDWARE

LB2010BLK-2M
LB2010BLK-1M1M

INSTALLATION MANUAL



LENGTH 6.6FT
FITS DOOR WIDTH UP TO 36IN

WWW.LUBANN.US

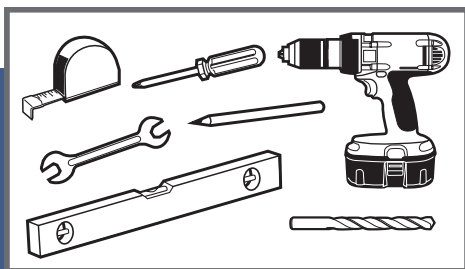

Tools Needed:

Pencil, philips head screwdriver, tape measure, power drill, assorted drill bits (incl. 5/16" and 3/8"), wrench set or adjustable wrench, level, squaring tool and wear all necessary safety gears for personal protection.

★ Track and all fasteners must be mounted into wood studs or wall blocking for maximum weight capacity. Alternatively, use a 1X4 header board with the same length as the track.



Optional:

If the 6.6FT track comes in two short tracks, please connect the two short tracks as in figure to make a 6.6FT track.

1 Determine track height and location

Decorative Sliding Door Track must be installed into a solid blocking or extended head casing.

WARNING: Do NOT install Flat Track Hardware solely on drywall or other wallboard surface as these surfaces may not support the track. Every track mounting screw used in the installation process needs to be securely fastened into a structural surface.

Use a stud finder to locate wood studs and wood blocking inside the wall as shown in figure .

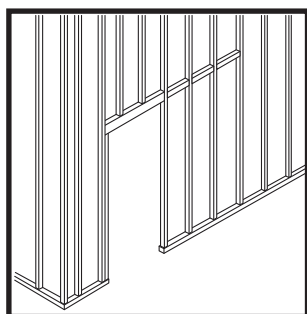

Measure up from the floor "door height+1-3/4 in." to the centerline of the track. Leave at least 2 in. from the end of the track to the side of the door opening. Use a level to level the track and mark screw holes. Drill 1/4 in. pilot holes.

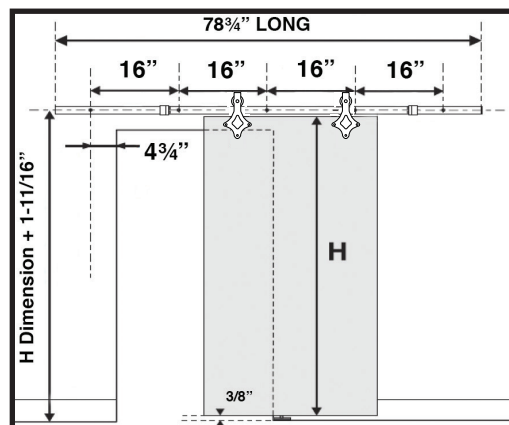

2 Install the track to the wall

Align spacers (i.e. standoffs) behind the track. Install flat washer on the lag bolt and attach track to the board or wall.

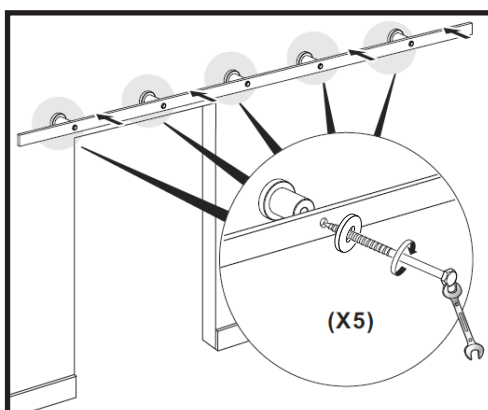

3 Attach the rollers to the door

Position roller on front of door so it is parallel to the edge of the door, leaving at least 2 in. between the edge of the door and the roller. Adjust vertical placement of rollers leaving 1-1/4 in. from the top of the door to the center of the first roller hole. Mark roller screw locations and repeat for the second roller. Using a 3/8 in. drill bit, drill through holes on the door. For 1-3/8 in. doors use 2-5/32 in. bolts and for 1-3/4 in. doors use 2-1/2 in. bolts to mount rollers as shown.

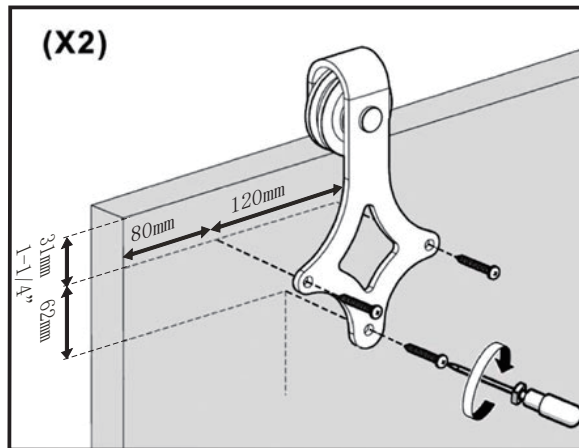

4 Installing anti-jump discs

Fasten anti-jump discs to top of door by placing them at least 1 in. from the edge of door.

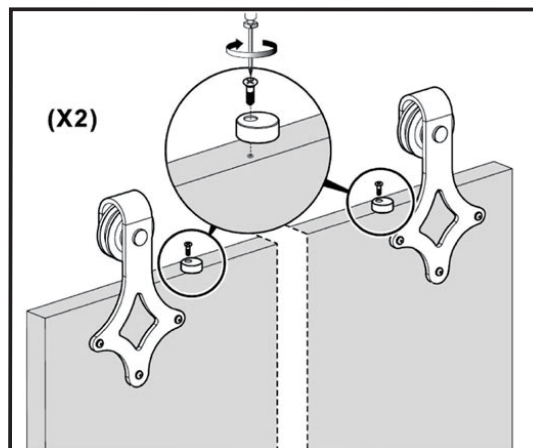

5 Place the door onto the track

Place assembled door with rollers onto track. Use a level to plumb the door. Make sure all parts work properly by sliding door back and forth.

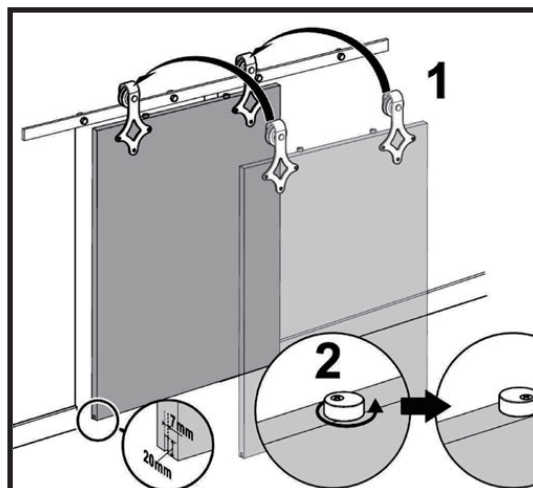

6 Install floor guide

After door is plumb, position one doorstop so door overlaps opening by 1 in. when in open position. Tighten doorstop once positioned correctly (do not tighten the second doorstop yet). Mark centerline of overlap and place center of Floor Guide in line. Slide the door closed and secure the Floor Guide. If going into a concrete floor, use provided anchors. Tighten the second doorstop. Slide door all the way to ensure proper Doorstop and Floor Guide installation.

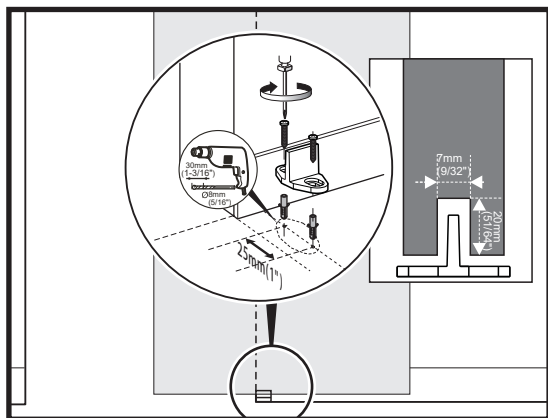

Floor guide:

Left if the bottom of the door is morticed
1/4" wide x 3/4" deep centrally.

Right if the door has no groove in the bottom.



7 Install door stops onto the track

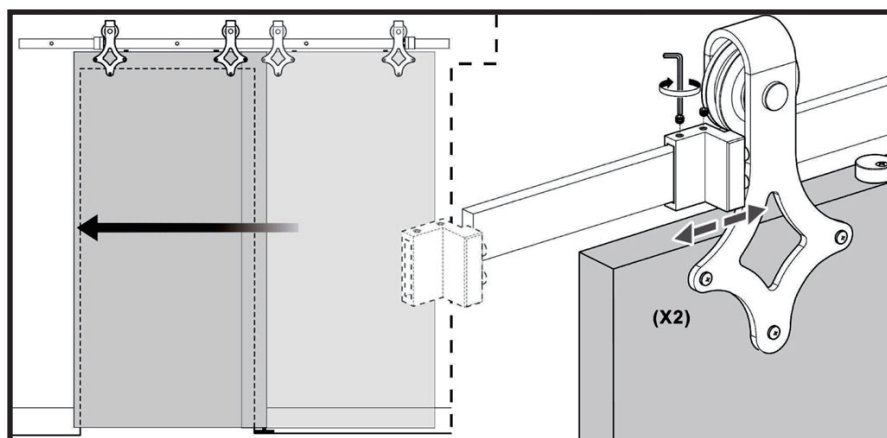

8 Connecting multiple tracks (optional)

If door opening is over 36 in., multiple tracks can be connected with Connecting Adapter for wider or bi-parting doors. Follow instructions on Connecting Adapter and steps 1 through 8 of above.

